



Brackets for PCI

- with or without fixing tab
- standard cut-outs
- custom-specific cut-outs
- custom-specific printings



Brackets for AT and similar

- with or without fixing tab
- standard cut-outs
- custom-specific cut-outs
- custom-specific printings



Custom-specific brackets

- double width
- special width
- with printing
- bracket (Retainer) for PCI cards

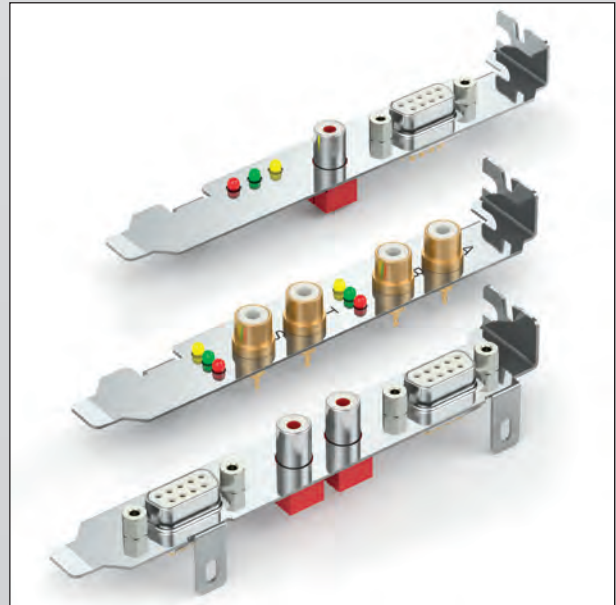

Equipped brackets

- equipped with D-Sub
- equipped with LED
- equipped with custom-specific components

Index Bracket-Groups

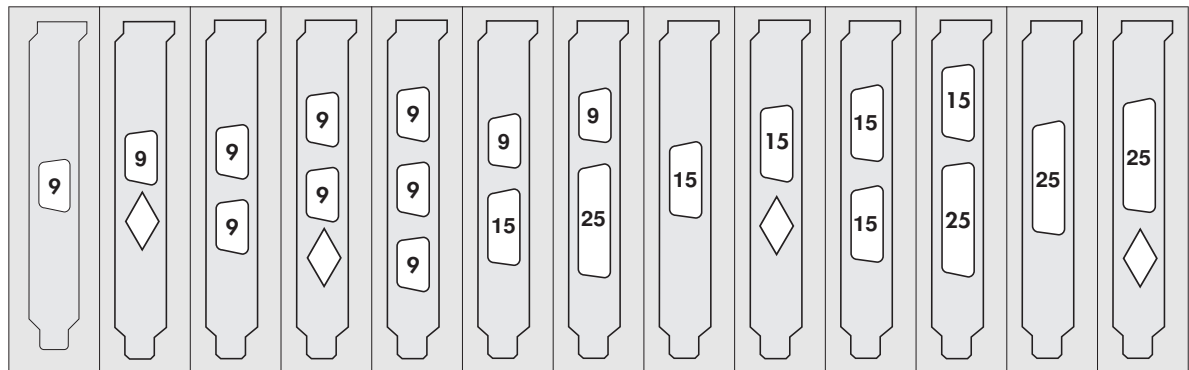

page	PCI	7		9			12	13	14		15		17	18
	KHPC	8	9	10	11	11	12	13	14	15	15	16	17	18

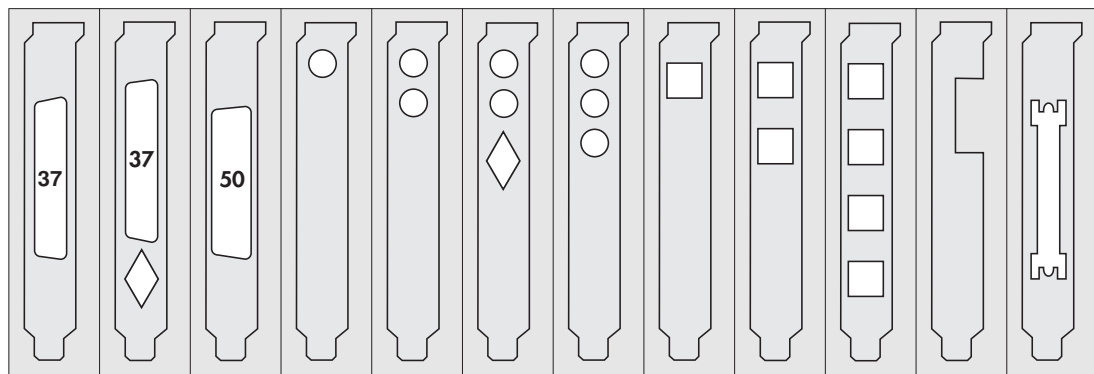

page	PCI	18			21		21		22		23			
	KHPC	19	20	20		21		22	22	23		24	24	

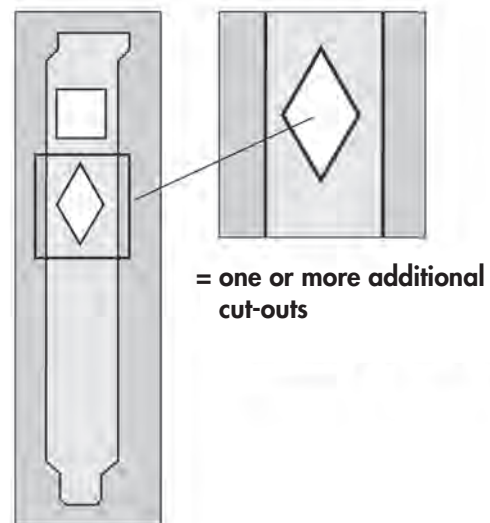

A

B

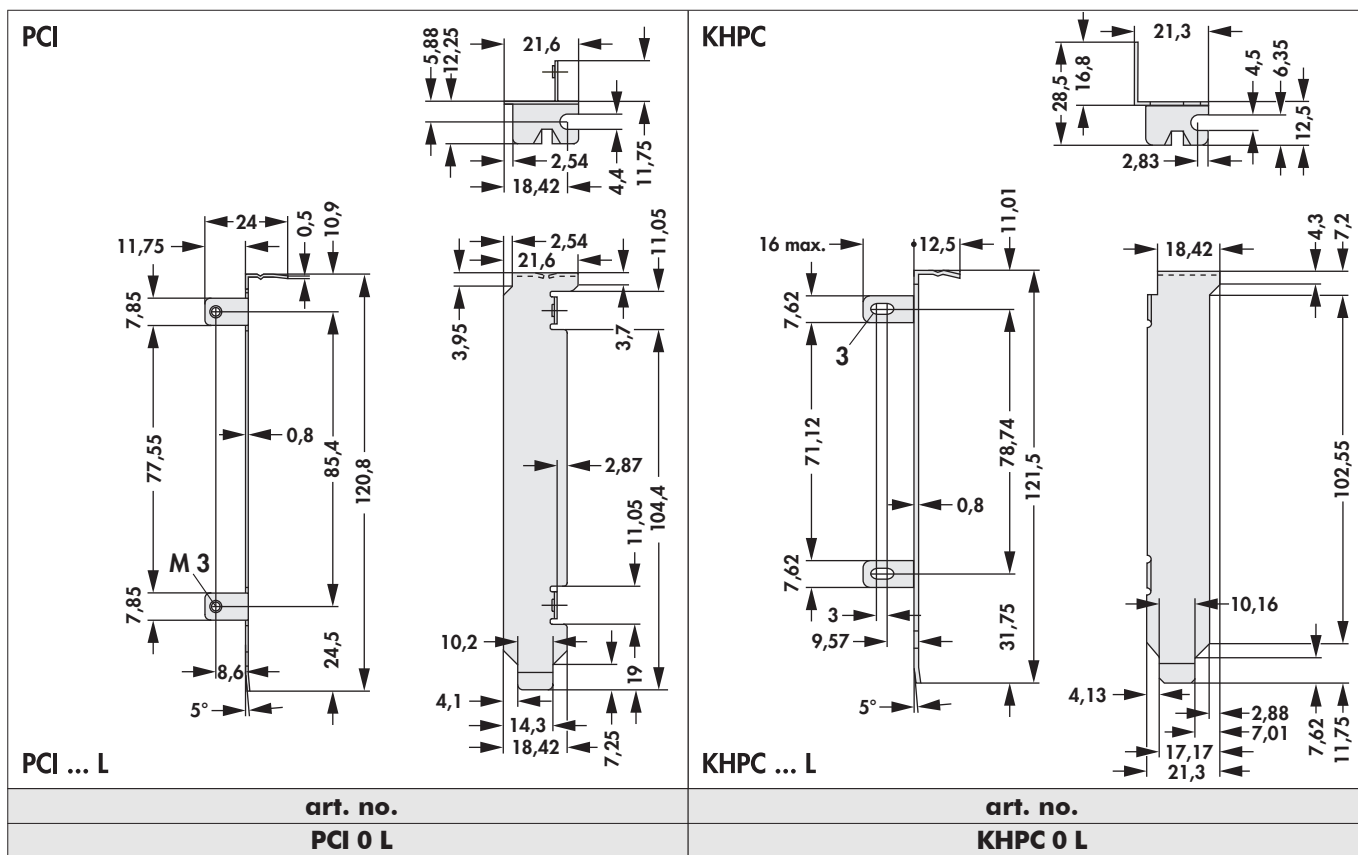
Brackets with fixing strap and without cutout

C

D

E

F

G

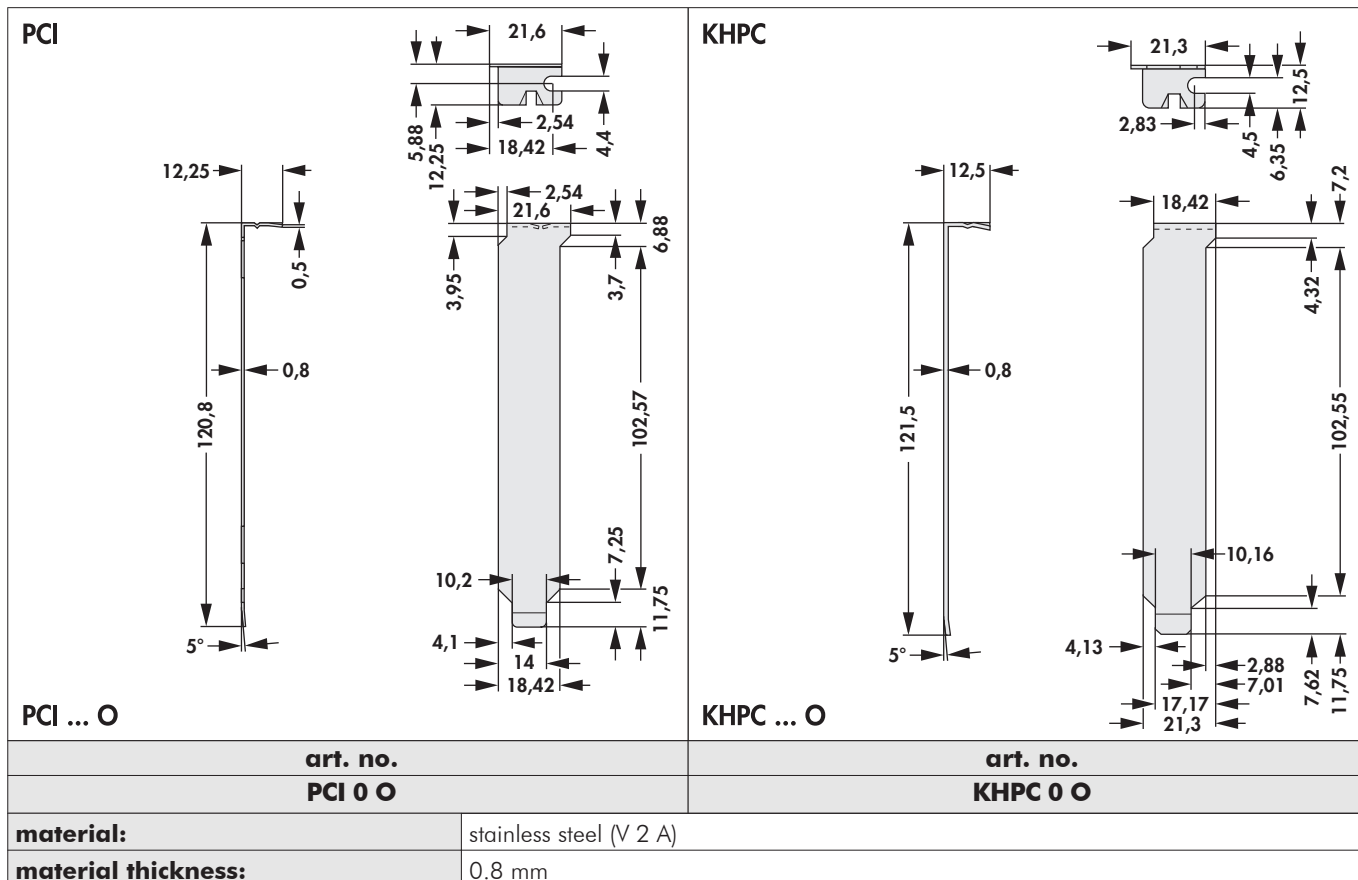
Bracket without fixing strap and without cutout

H

I

K

L

M

N

K 3
EL.ITALIA

 www.elitaliaweb.it
 info@elitaliaweb.it
 +39 0233611626



Low Profile bracket for PC

Low Profile bracket with fixing strap and without cutout

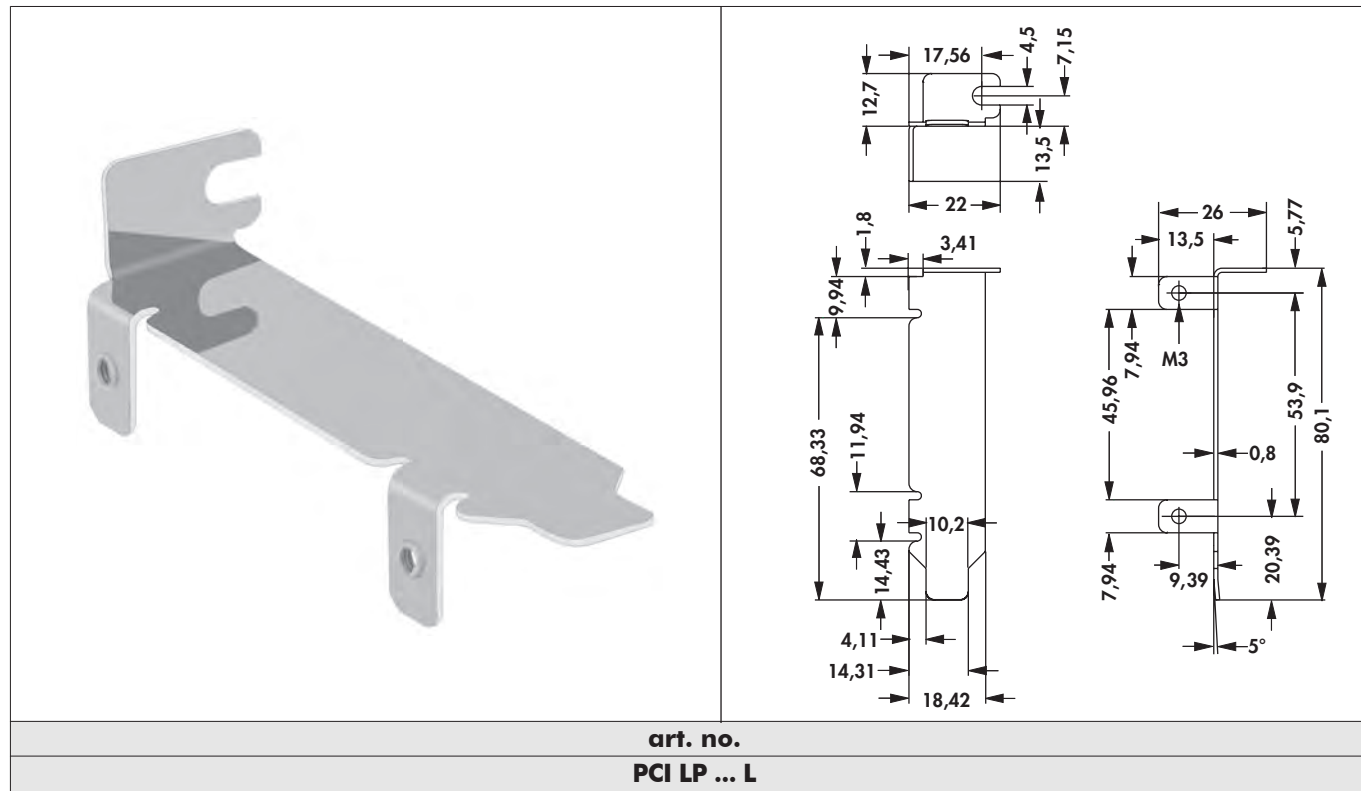
- with or without fixing tap; standard cutouts
- customer-specific cutouts and printing; double width (special widths) on request

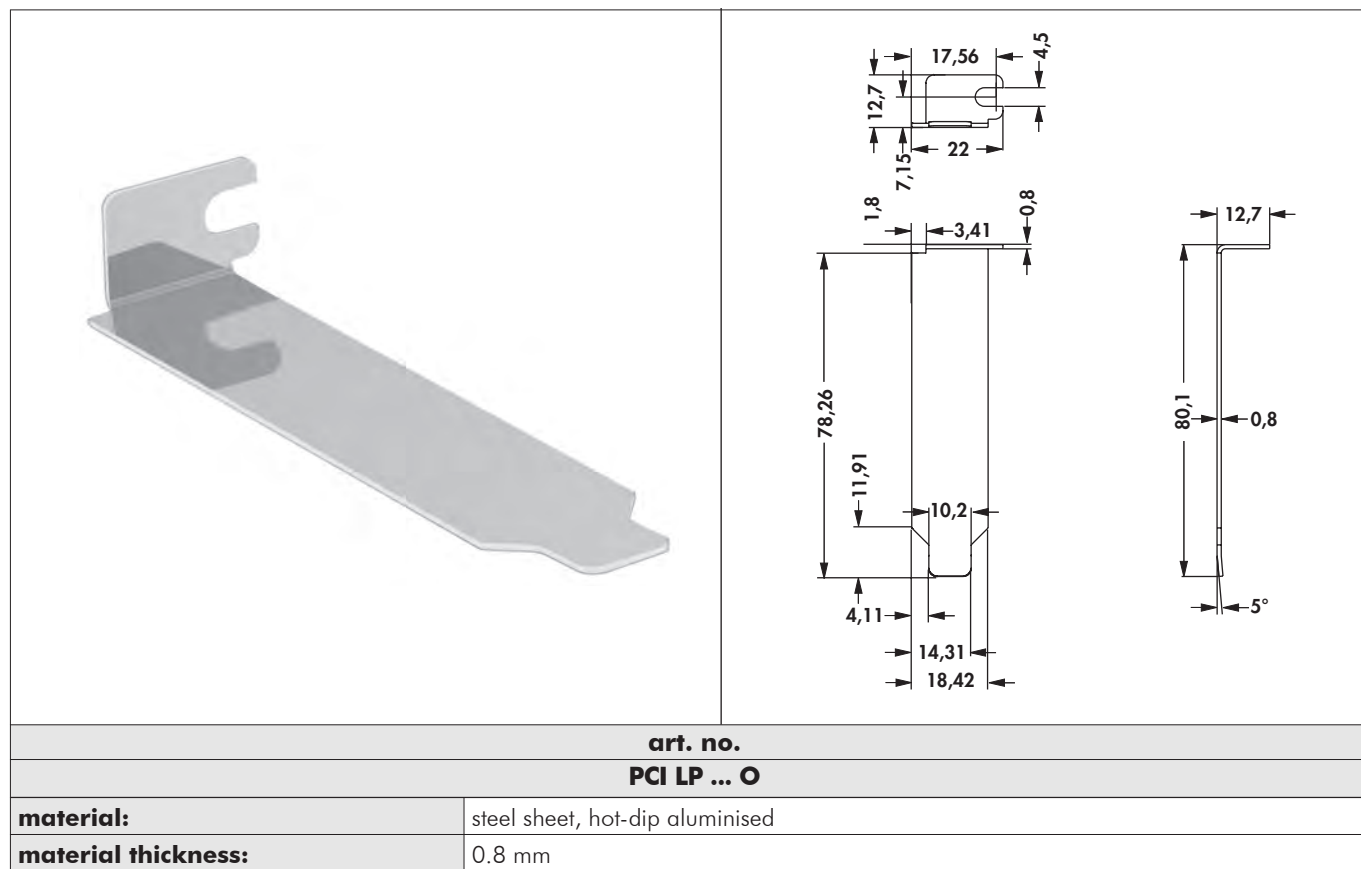

Low Profile bracket without fixing strap and without cutout



A

Dimensional drawing for PCBs

B

C

D

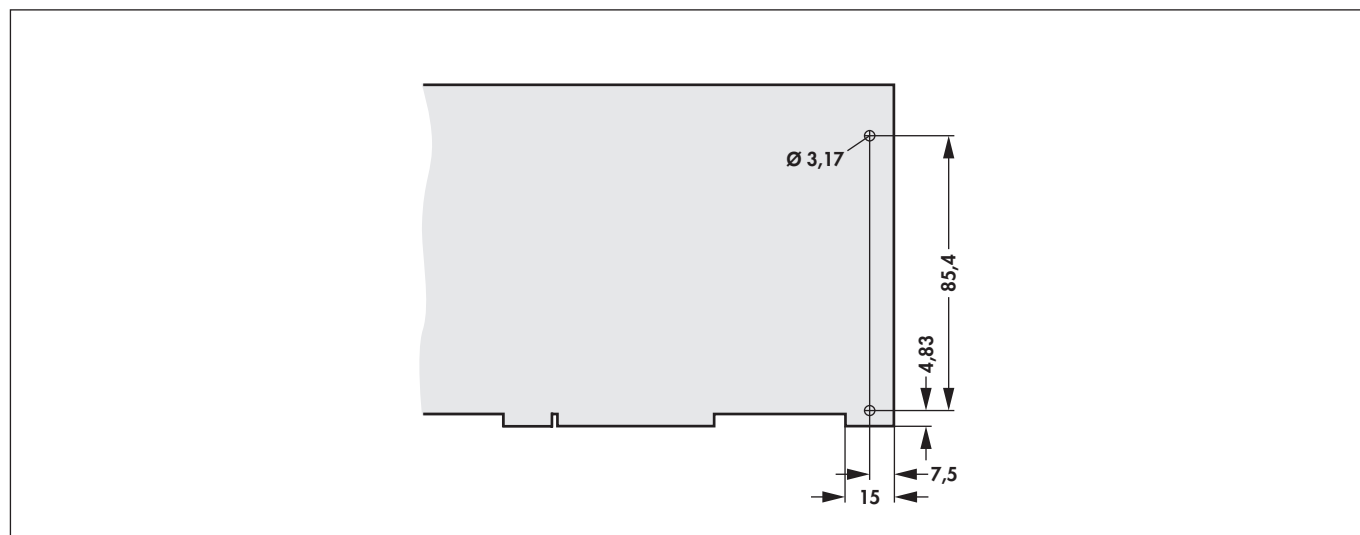

Dimensions to fix the PCI L ... - bracket to the PCB

E

F

G

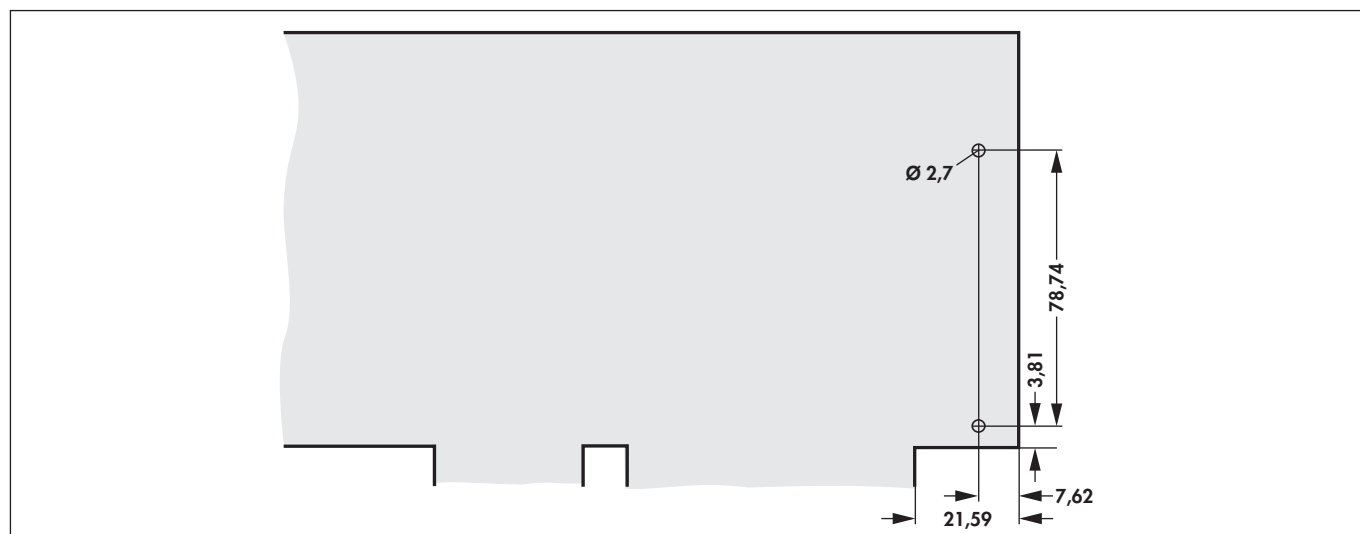
H



Dimensions to fix the KHPC L ... - bracket to the PCB

I

K

L

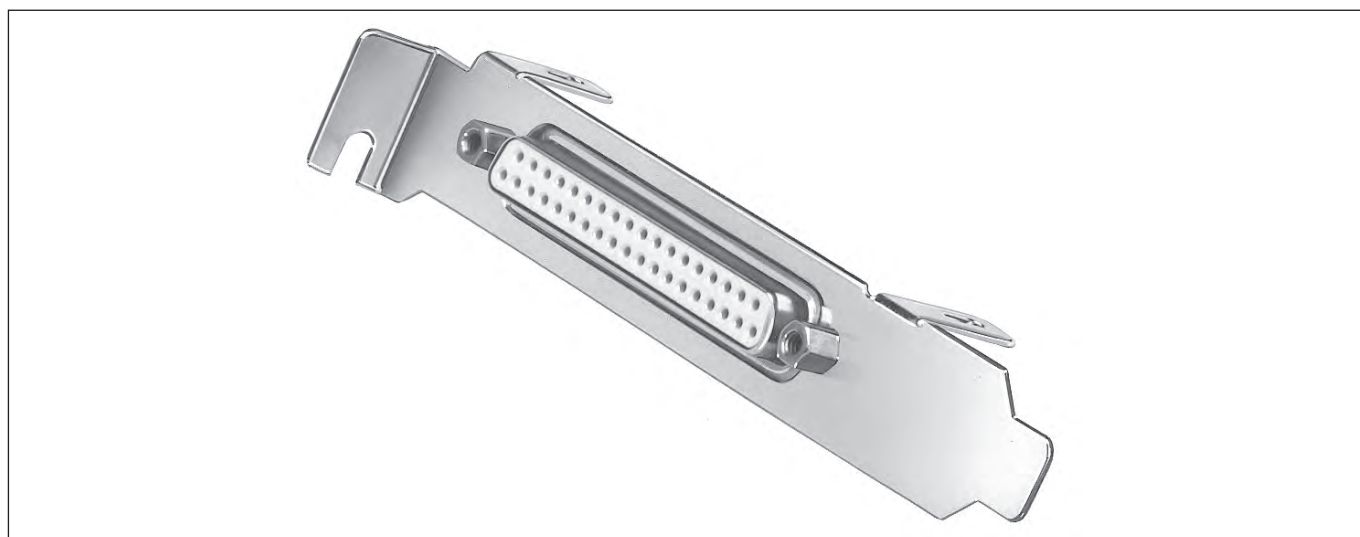
M



On request also available with D-Sub connector!

N

K 5
EL.ITALIA

 www.elitaliaweb.it
 info@elitaliaweb.it
 +39 0233611626

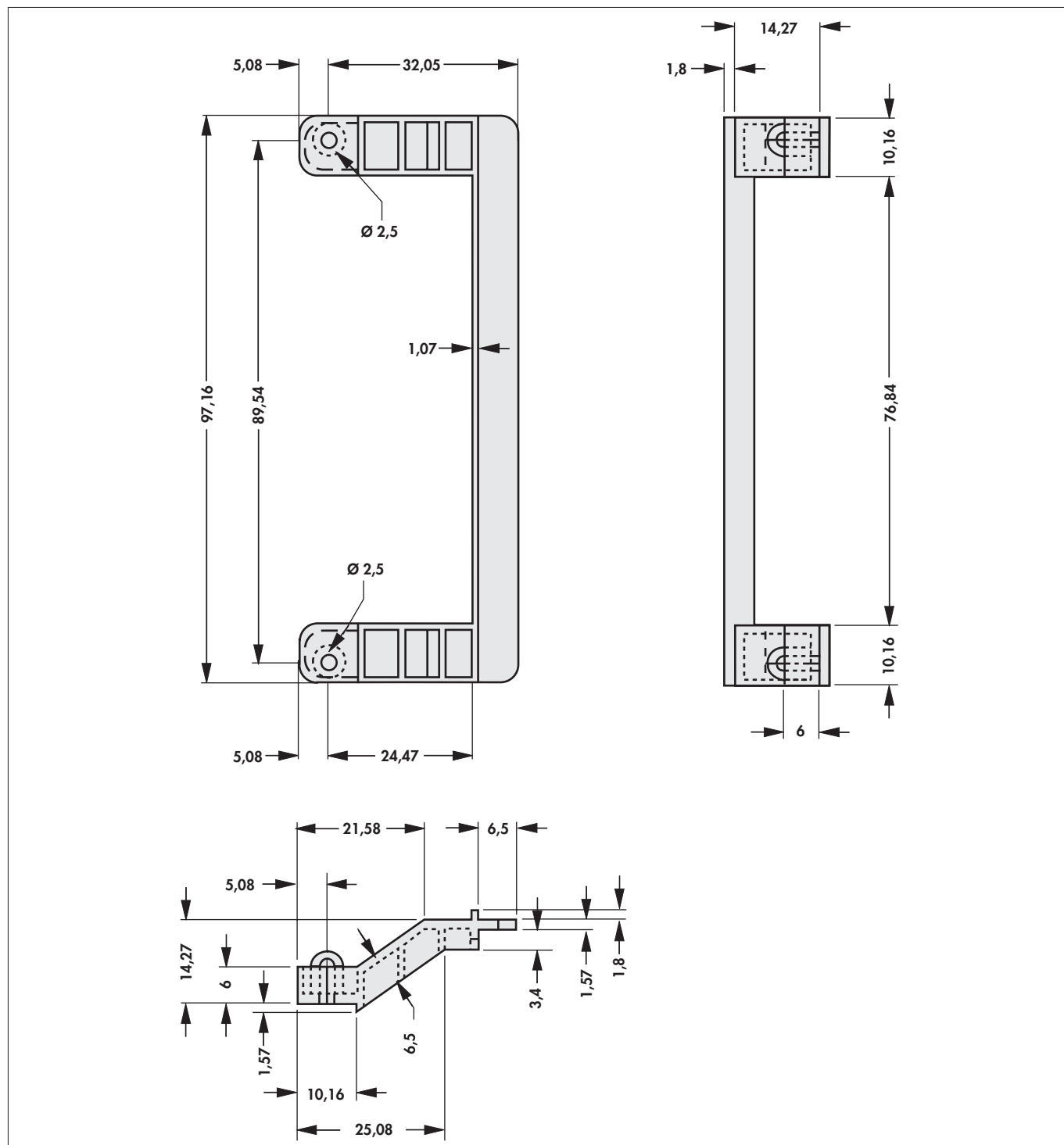
– suitable for all ISA-versions



art. no.
PCI R1

class of inflammability:	UL 94 V-0
material:	polycarbonate



EL.ITALIA

www.elitaliaweb.it
info@elitaliaweb.it
+39 0233611626

K 6

A

B

C

D

E

F

G

H

I

K

L

M

N

A

B

C

D

E

F

G

H

I

K

L

M

N

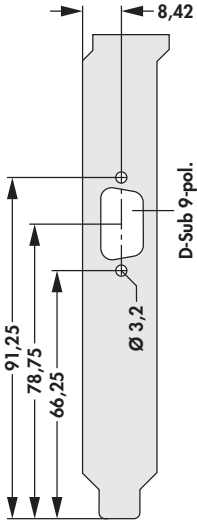
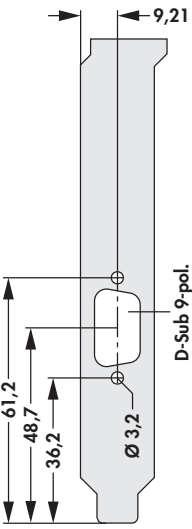
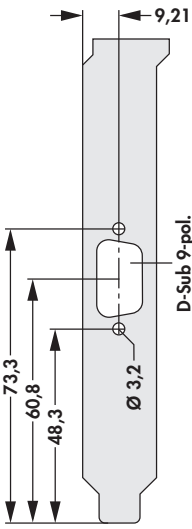
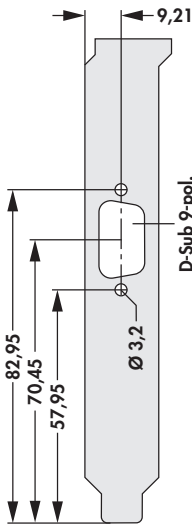
	PCI 055 ...	PCI 004 ...	PCI 005 ...
<p>PCI 006 O</p> 			

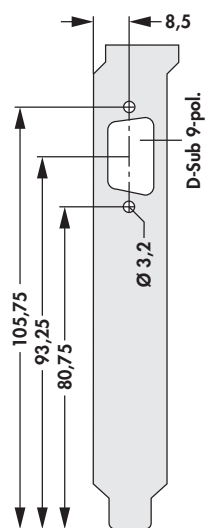
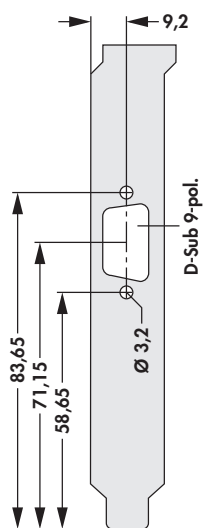
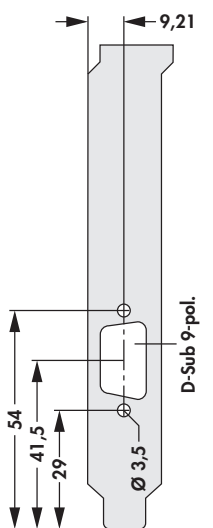
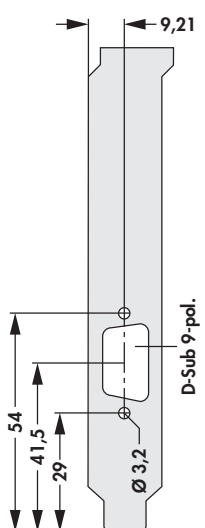
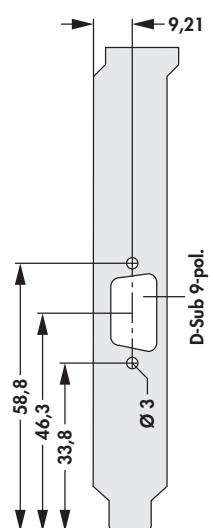
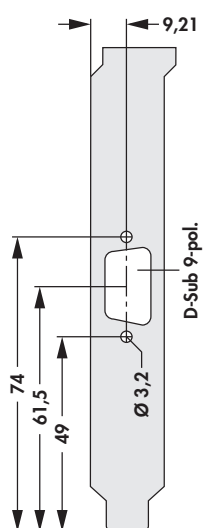
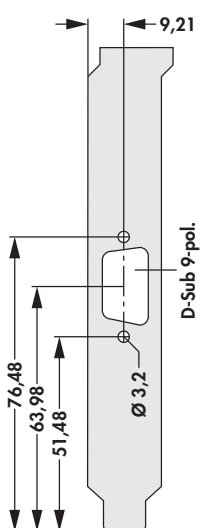
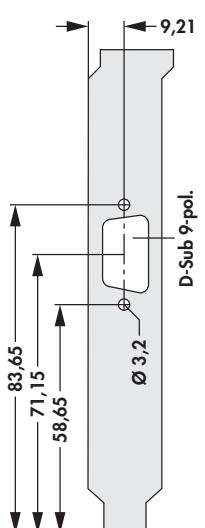
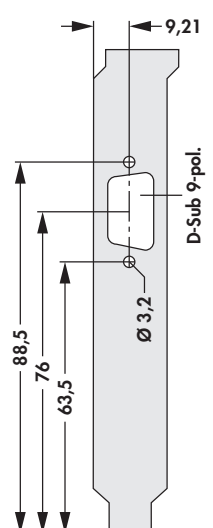
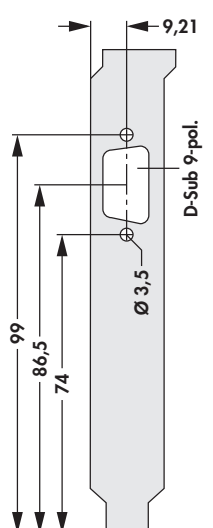
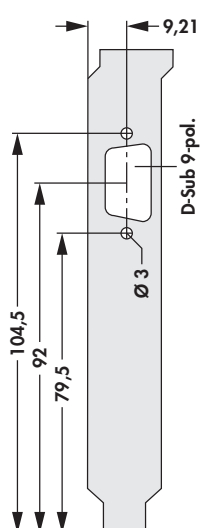

	<p>KHPC 002 O</p> 	<p>KHPC 003 ...</p> 	<p>KHPC 007 O</p> 
<p>KHPC 011 O</p> 	<p>KHPC 013 O</p> 	<p>KHPC 010 ...</p> 	<p>KHPC 093 L</p> 
<p>KHPC 094 O</p> 	<p>KHPC 096 O</p> 	<p>KHPC 008 O</p> 	<p>KHPC 014 O</p> 



A

B

C

D

E

F

G

H





I

K

L

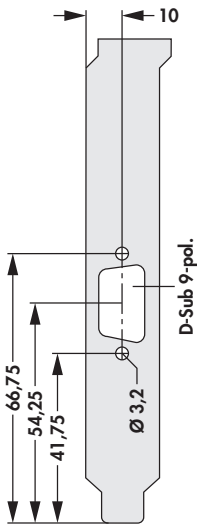
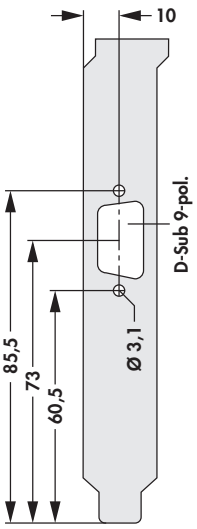
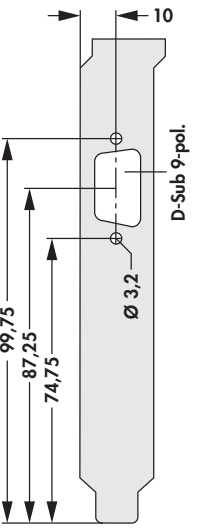
M

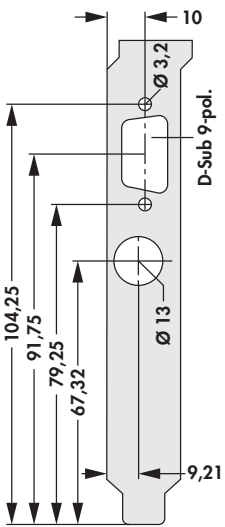
N

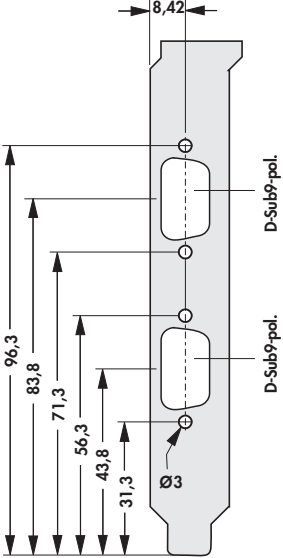
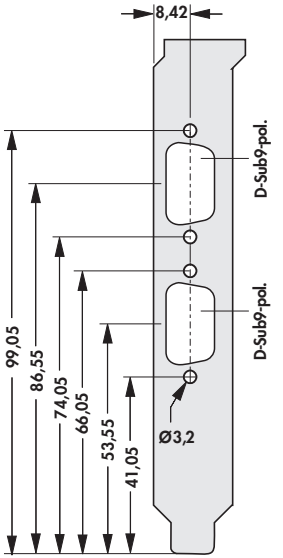
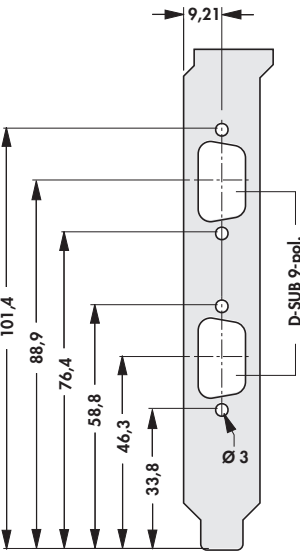
	<p>KHPC 016 O</p> 	<p>KHPC 095 O</p> 	<p>KHPC 017 ...</p> 
	<p>KHPC 131 L</p> 		
	<p>PCI 011 ...</p> 	<p>PCI 013 ...</p> 	<p>PCI 039 O</p> 

K 9
EL.ITALIA

 www.elitaliaweb.it
 info@elitaliaweb.it
 +39 0233611626

<p>PCI 041 ...</p>	<p>PCI 012 ...</p>		
	<p>KHPC 144 O</p>	<p>KHPC 142 O</p>	<p>KHPC 053 O</p>
<p>KHPC 138 O</p>	<p>KHPC 006 O</p>	<p>KHPC 012 O</p>	<p>KHPC 141 O</p>



A

B

C

D

E

F

G

H

I

K

L

M

N

<p>KHPC 072</p>	<p>KHPC 009 O</p>	<p>KHPC 143 O</p>	<p>KHPC 015 L</p>
	<p>KHPC 160 O</p>		
	<p>KHPC 065 O</p>	<p>KHPC 454 O</p>	<p>KHPC 005 O</p>



	<p>PCI 065 O</p>	<p>PCI 031 O</p>	<p>PCI 032 O</p>
	<p>KHPC 179 O</p>	<p>KHPC 177 O</p>	<p>KHPC 178 O</p>
<p>KHPC 076 O</p>			



A

B

C

D

E

F

G

H



I

K

L

M

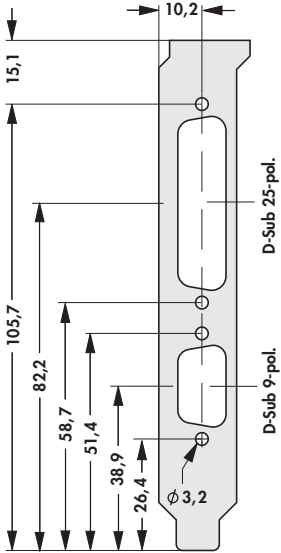
N

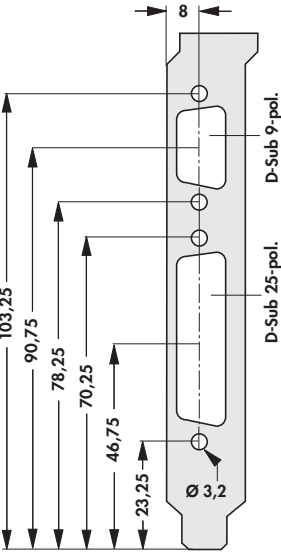
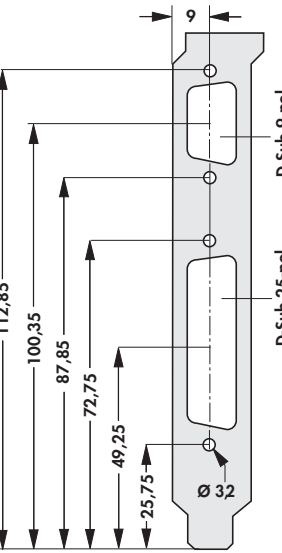
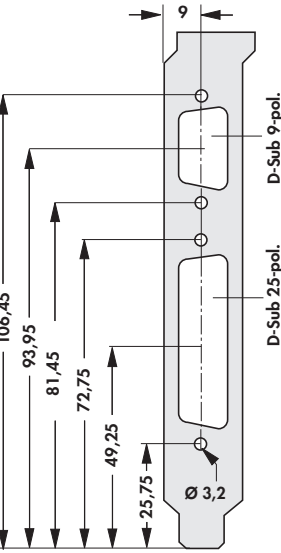
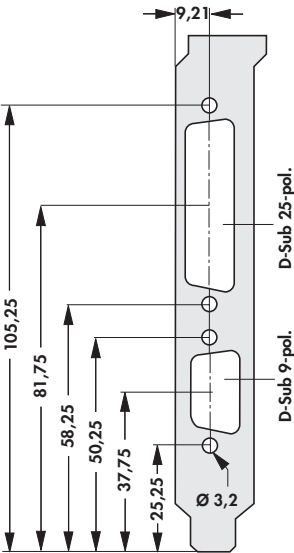
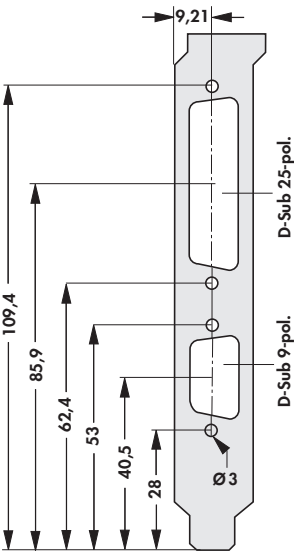
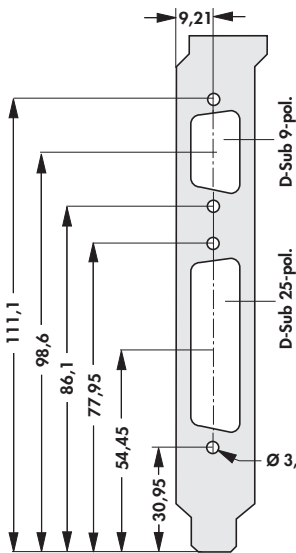
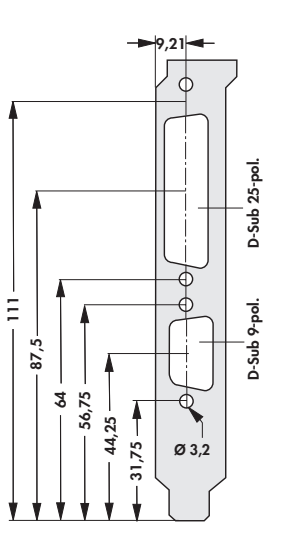
	<p>PCI 033 ...</p> 		
	<p>KHPC 189 L</p> 	<p>KHPC 041 O</p> 	<p>KHPC 040 O</p> 
<p>KHPC 185 O</p> 	<p>KHPC 061 O</p> 	<p>KHPC 038 O</p> 	<p>KHPC 187 O</p> 



<p>KHPC 188 O</p>	<p>KHPC 078 O</p>		
	<p>PCI 014 L</p>	<p>PCI 045 ...</p>	<p>PCI 015 ...</p>
	<p>KHPC 019 O</p>	<p>KHPC 073 ...</p>	<p>KHPC 024 O</p>

A

B

C

D

E

F

G

H

I

K

L

M

N

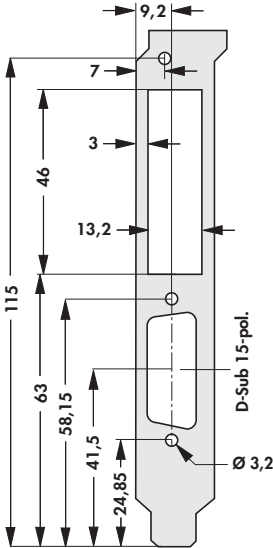
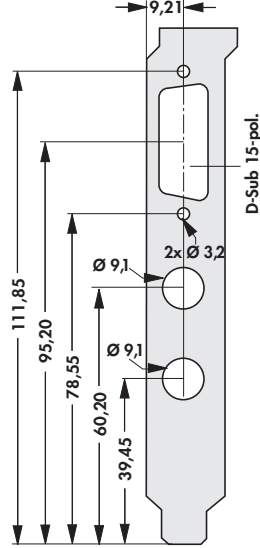
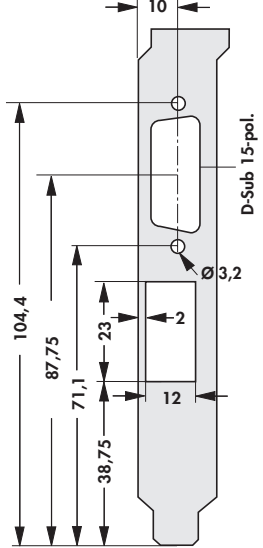
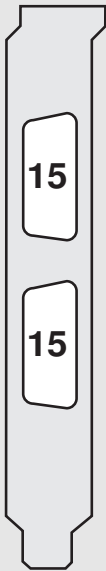
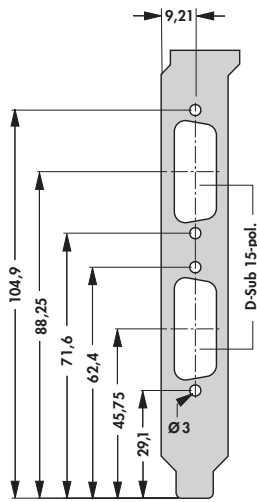
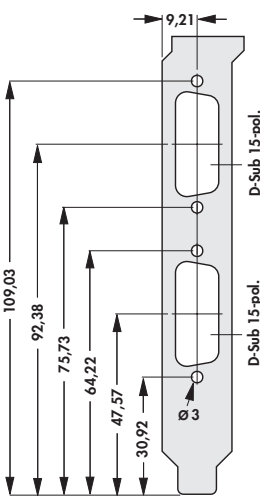
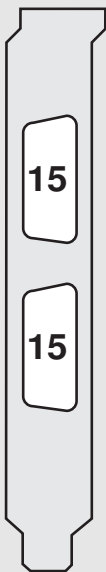
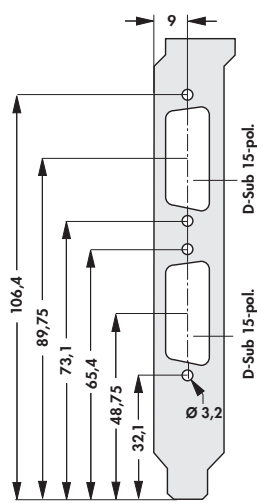
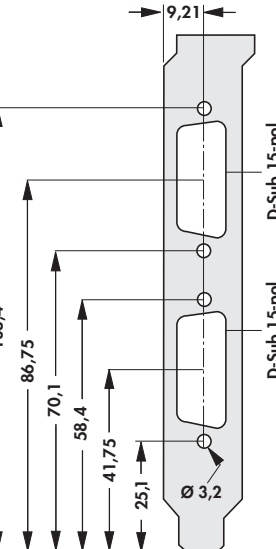
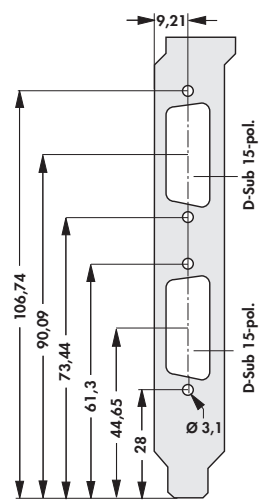
	<p>KHPC 200 O</p> 	<p>KHPC 455 L</p> 	<p>KHPC 218 O</p> 
	<p>PCI 047 O</p> 	<p>PCI 071 O</p> 	
	<p>KHPC 230 O</p> 	<p>KHPC 022 L</p> 	<p>KHPC 225 O</p> 

K 15
EL.ITALIA

 www.elitaliaweb.it
 info@elitaliaweb.it
 +39 0233611626

<p>KHPC 069 O</p>	<p>KHPC 229 O</p>	<p>KHPC 018 O</p>	
	<p>KHPC 042 O</p>	<p>KHPC 241 O</p>	<p>KHPC 242 O</p>
<p>KHPC 075 O</p>			

A

B

C

D

E

F

G

H

I

K

L

M

N

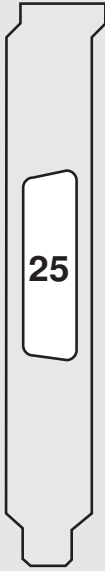
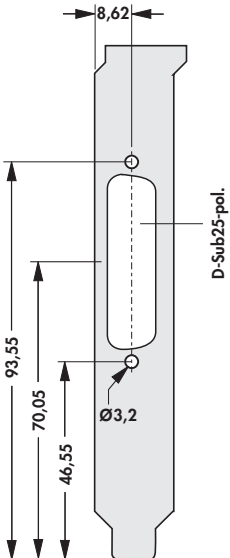
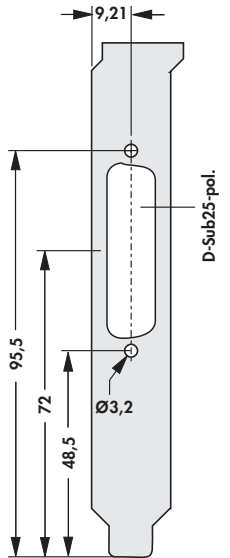
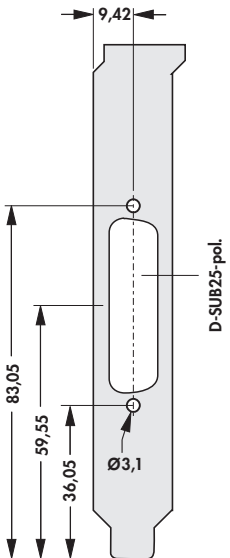
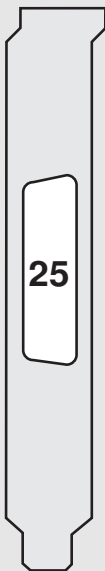
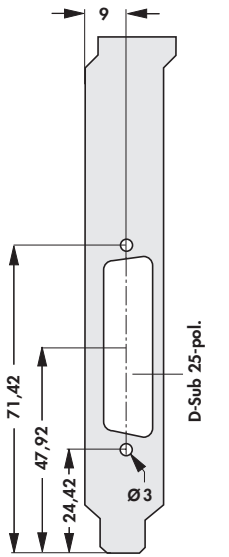
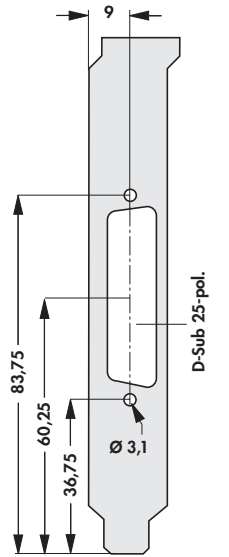
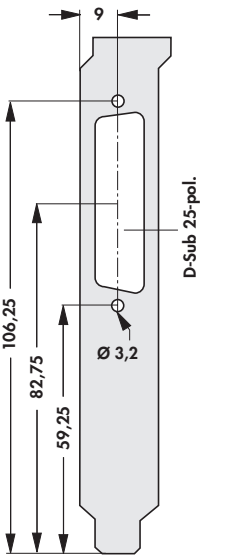
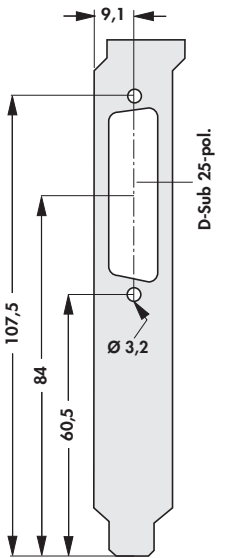
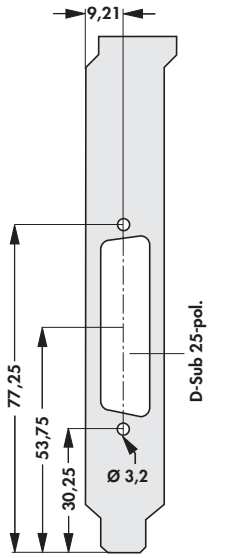
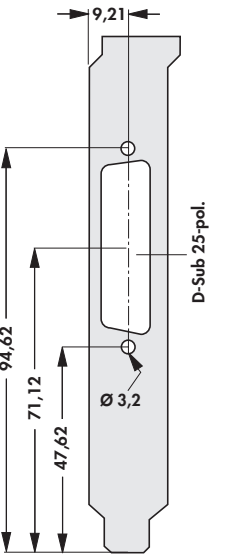
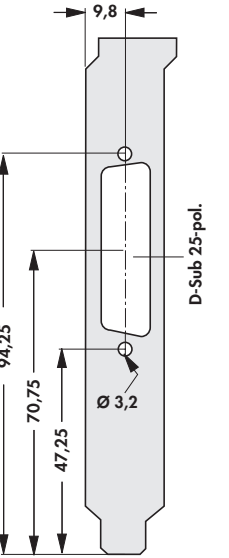
 <p style="text-align: center;">25</p>	<p style="text-align: center;">PCI 017 ...</p> 	<p style="text-align: center;">PCI 018 ...</p> 	<p style="text-align: center;">PCI 016 L</p> 
 <p style="text-align: center;">25</p>	<p style="text-align: center;">KHPC 243 O</p> 	<p style="text-align: center;">KHPC 070 O</p> 	<p style="text-align: center;">KHPC 027 O</p> 
<p style="text-align: center;">KHPC 054 O</p> 	<p style="text-align: center;">KHPC 028 O</p> 	<p style="text-align: center;">KHPC 026 ...</p> 	<p style="text-align: center;">KHPC 052 L</p> 

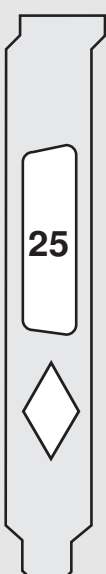
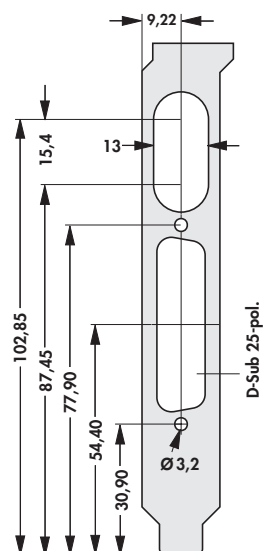
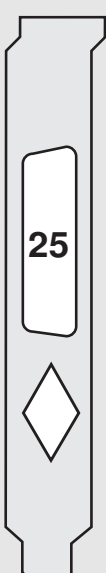
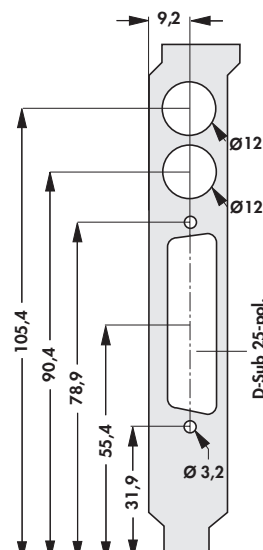
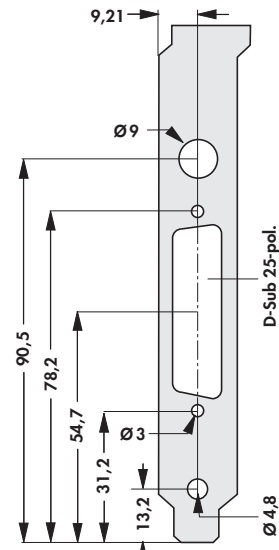
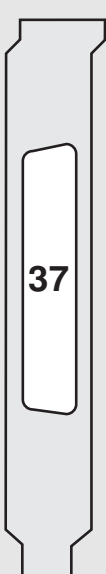
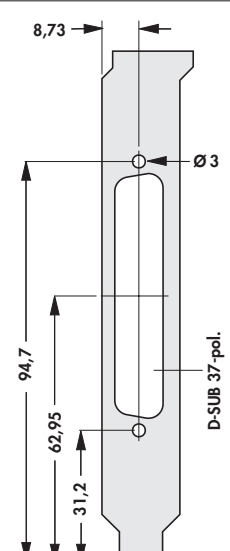
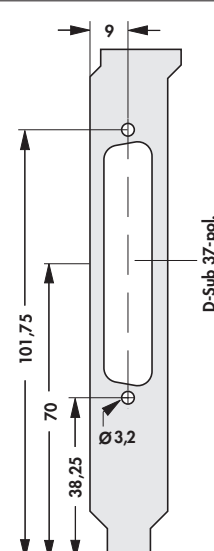
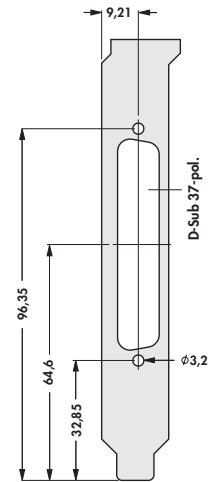

 <p>25</p>	<p>PCI 072 O</p> 		
 <p>25</p>	<p>KHPC 262 O</p> 	<p>KHPC 043 O</p> 	
 <p>37</p>	<p>PCI 076 O</p> 	<p>PCI 035 L</p> 	<p>PCI 077 ...</p> 

A

B

C

D

E

F

G

H

I

K

L

M

N

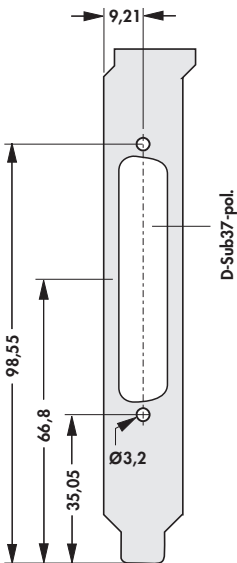
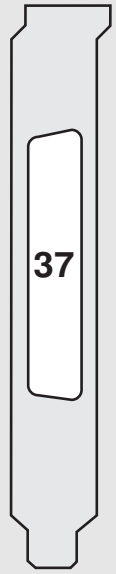
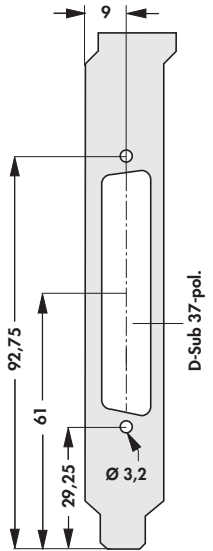
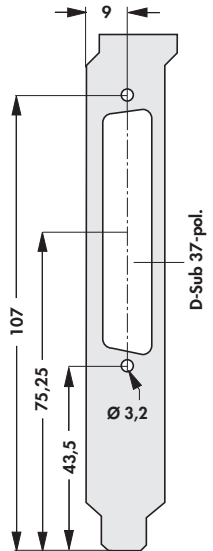
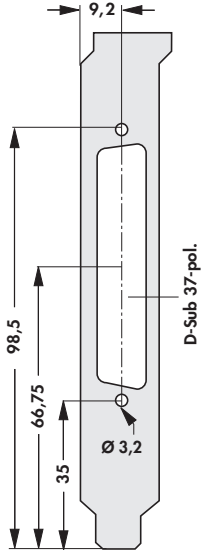
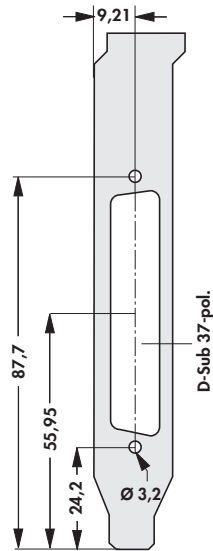
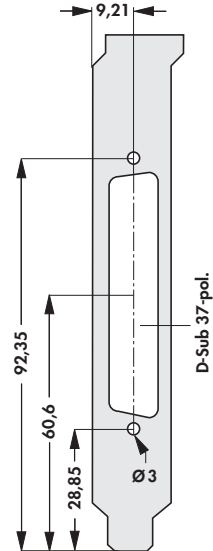
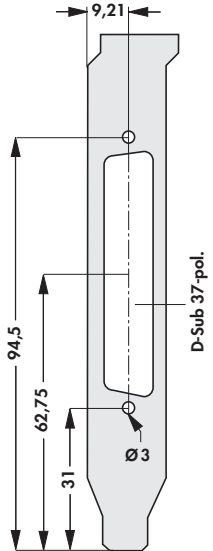
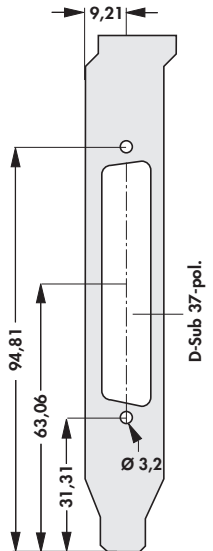
<p>PCI 020 ...</p> 			
	<p>KHPC 058 O</p> 	<p>KHPC 035 O</p> 	<p>KHPC 277 O</p> 
<p>KHPC 267 O</p> 	<p>KHPC 033 O</p> 	<p>KHPC 270 O</p> 	<p>KHPC 271 O</p> 



<p>KHPC 034 O</p> <p>D-Sub 37-pol.</p>	<p>KHPC 031 O</p> <p>D-Sub 37-pol.</p>	<p>KHPC 032 O</p> <p>D-Sub 37-pol.</p>	
<p>37</p>	<p>KHPC 029 O</p> <p>D-Sub 37-pol.</p>	<p>KHPC 295 O</p> <p>D-Sub 37-pol.</p>	
<p>50</p>	<p>KHPC 036 ...</p> <p>D-Sub 50-pol.</p>	<p>KHPC 051 O</p> <p>D-Sub 50-pol.</p>	<p>KHPC 308 L</p> <p>D-Sub 50-pol.</p>



A

Brackets for PC

B

C

D

E

F

G

H



I

K

L



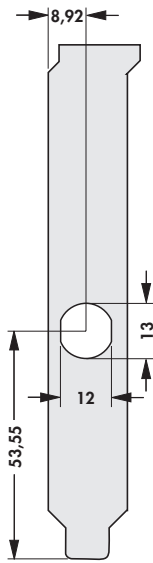

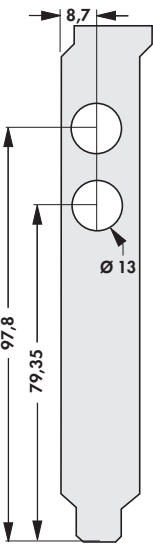
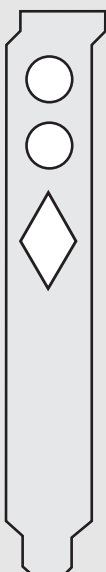
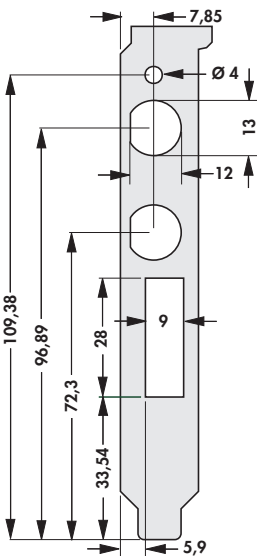
M

N

	<p>PCI 021 O</p>  <p>8,92 53,55 12 13</p>		
	<p>KHPC 325 O</p>  <p>8,7 97,8 79,35 Ø 13</p>		
	<p>PCI 083 L</p>  <p>109,38 96,89 72,3 33,54 5,9 7,85 Ø 4 13 12 9</p>		

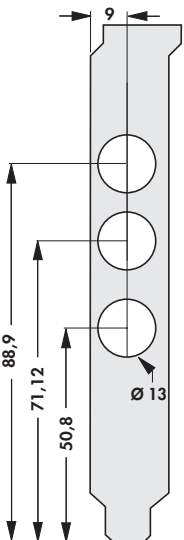
K 21
EL.ITALIA

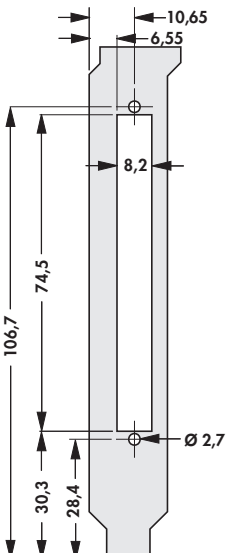
 www.elitaliaweb.it
 info@elitaliaweb.it
 +39 0233611626

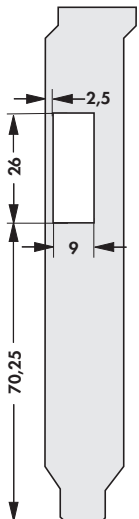
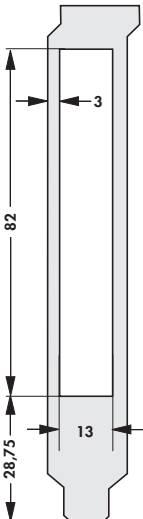
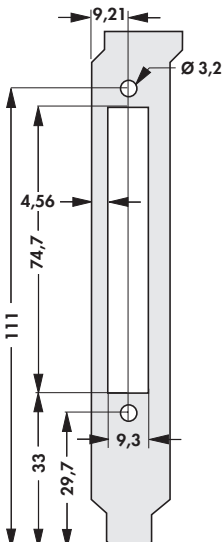
	<p>KHPC 335 L</p> 		
	<p>PCI 104 O</p> 		
	<p>KHPC 365 L</p> 	<p>KHPC 085 L</p> 	<p>KHPC 391 O</p> 

A

Brackets for PC

B

C

D

E

F

G

H

I

K

L

M

N

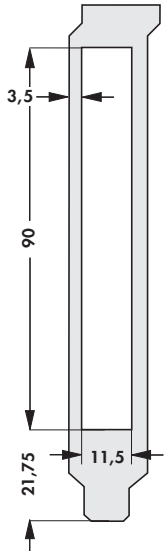
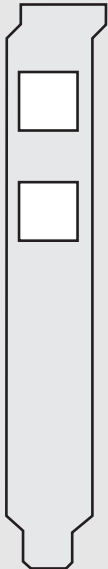
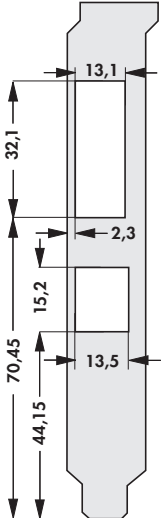
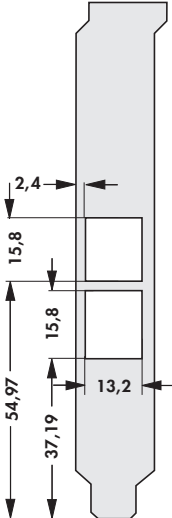
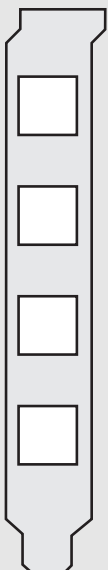
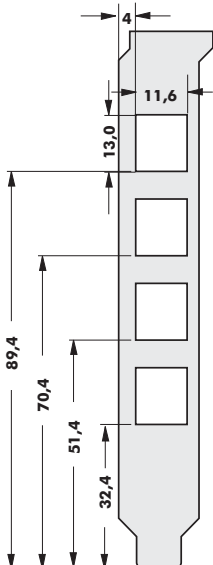
<p>KHPC 398 O</p> 			
	<p>KHPC 404 L</p> 	<p>KHPC 407 L</p> 	
	<p>PCI 051 ...</p> 		



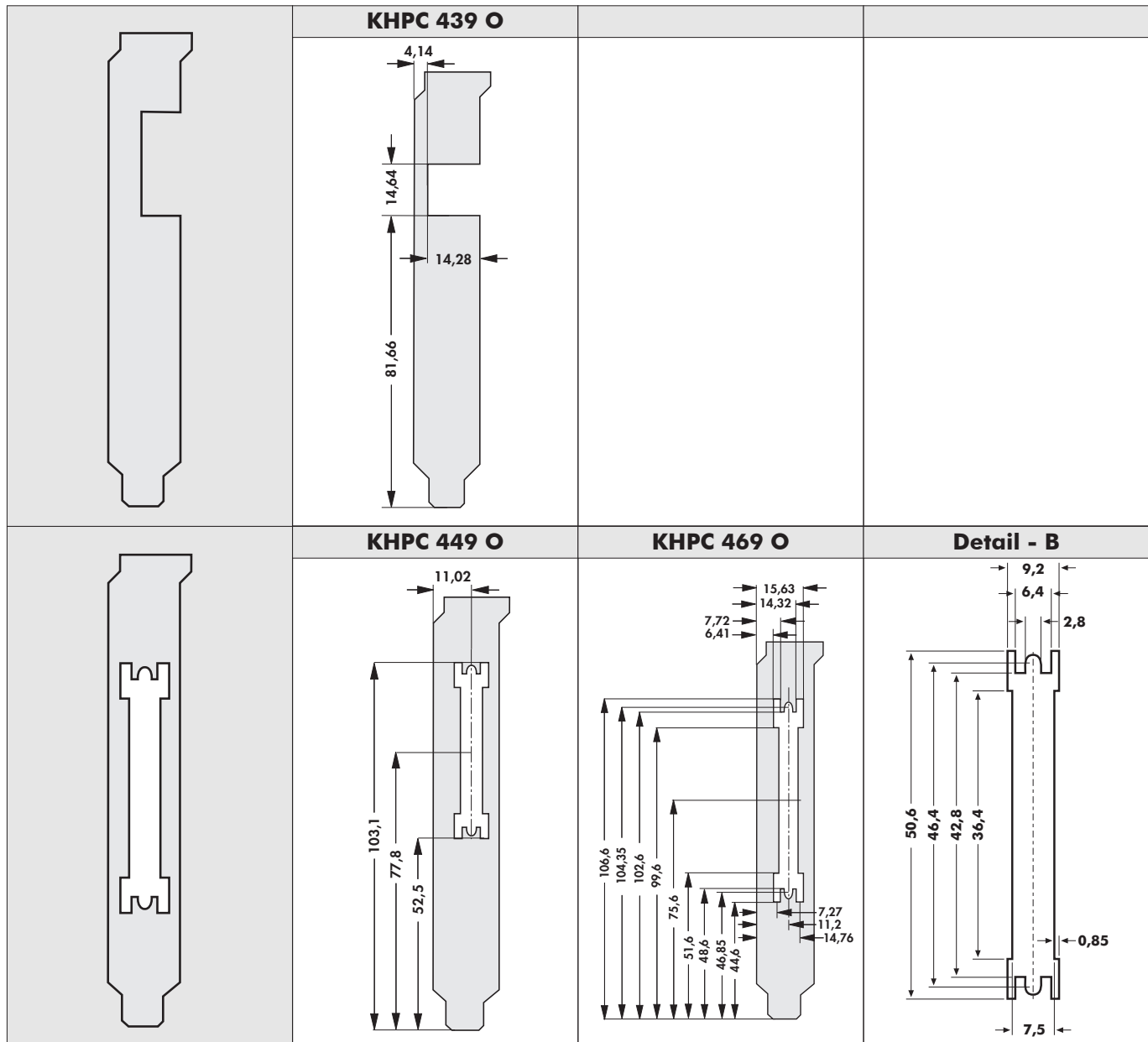

User information für PCI and KHPC-Design
PCI- and KHPC-DESIGN

The cutouts shown on the Design sheet should be positioned on the pictured grid.

The zero point of the respective cutout is to be placed on the grid point of the PC card bracket, whereby the X/Y coordinates should be entered in the table as absolute dimensions. Positioning of the cutouts can be specified with an accuracy of max. 0,01 mm. The grid specifies the max. area of the cutout including the component. Please mark whether the version is with or without bent fixing tabs.

Other contours, dimensions and cutouts are possible, to the extent that they are technically possible to produce.

Please contact us with regard to this.

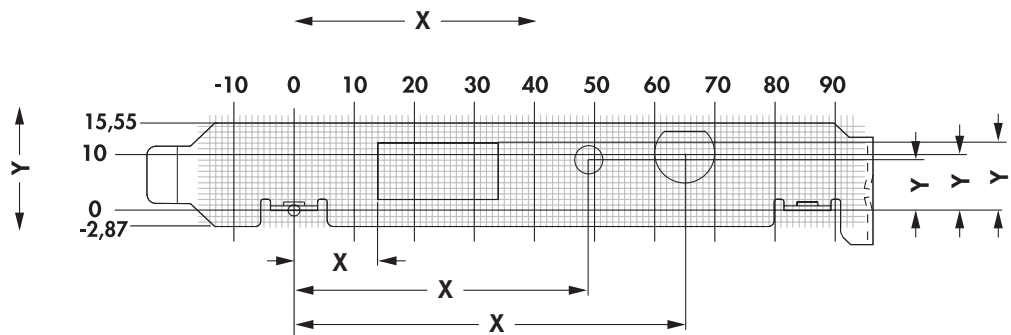
Example
PCI

Shape	X-dimension	Y-dimension
A A = 20 B = 10	14	12
E D = 5	49	9
D1 D = 12 D1 = 11	65	10

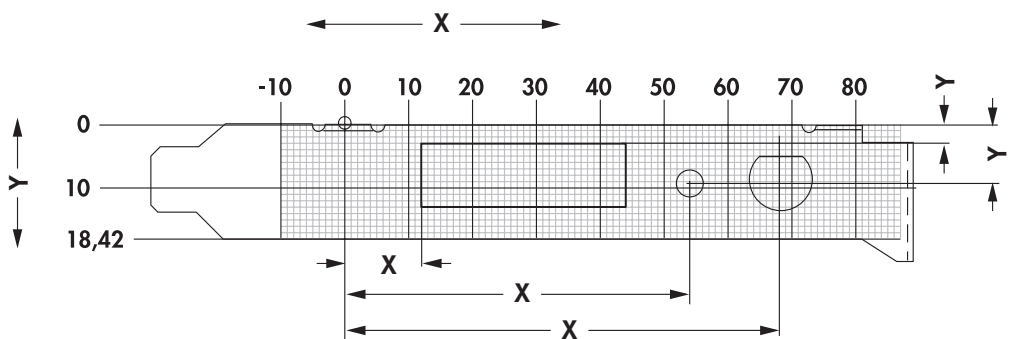
KHPC

Shape	X-dimension	Y-dimension
A A = 33 B = 10	12	3
E D = 5	54	9
D1 D = 9,5 D1 = 8,7	68	9

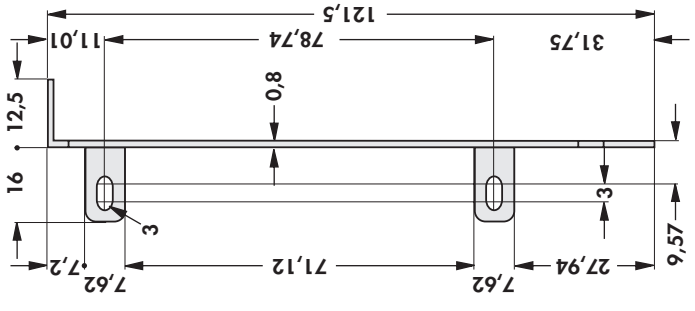
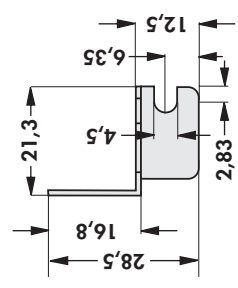
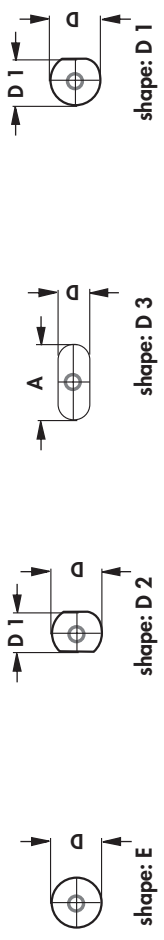
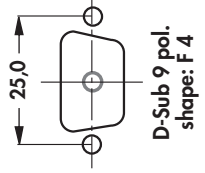
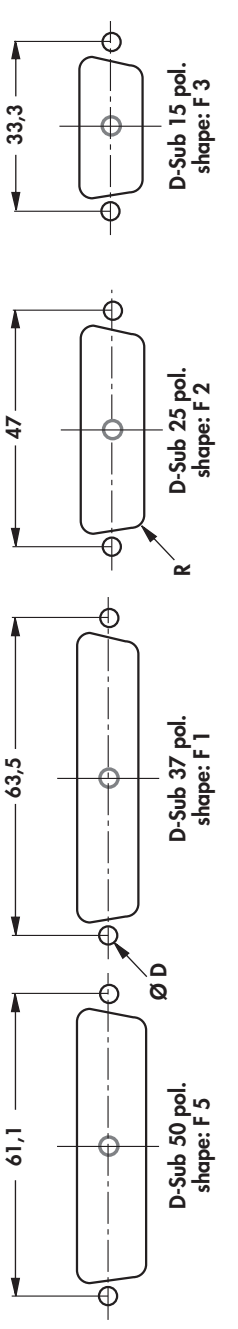

- with fixing strap
- without fixing strap

- radius F 1 ... 4
 build in mode:
 3,4 mm rear
 2,1 mm front

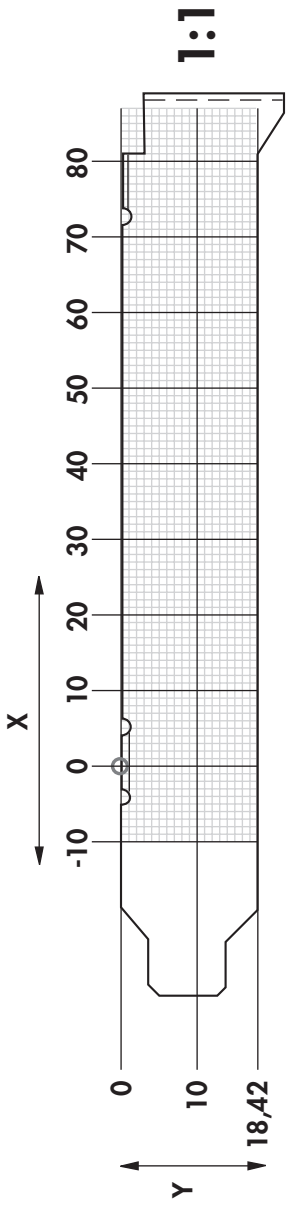
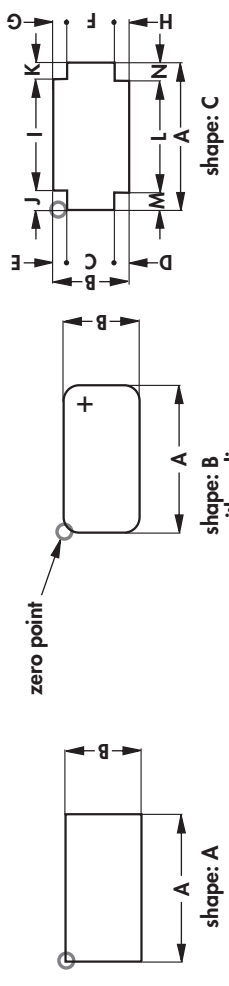

shape	X-dim.	Y-dim.	A	B	C	D	D 1	E	F	G	H	I	J	K	L	M	N

KHPC DESIGN

company name:

part name:

drawing number:

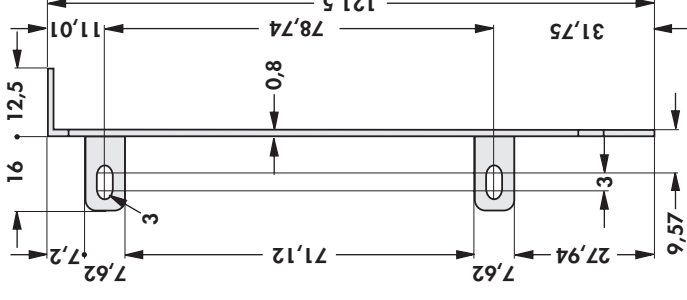
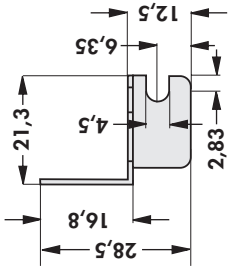
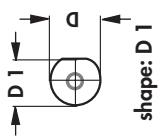
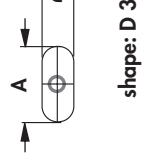
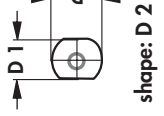
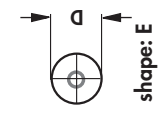
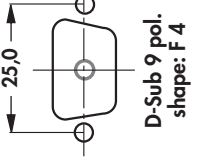
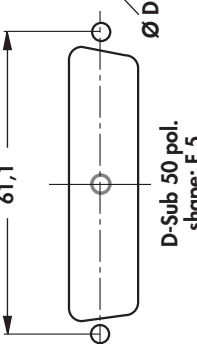
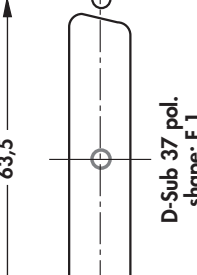
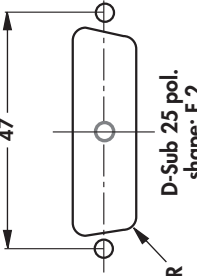
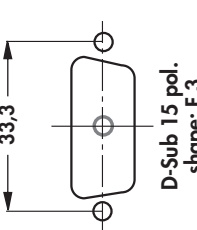

- with fixing strap
- without fixing strap

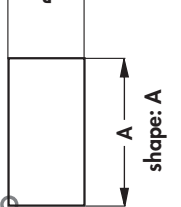
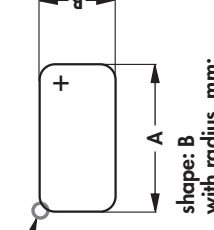
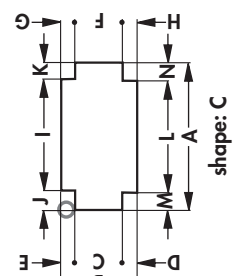

- radius F 1 ... 4
- build in mode:
 - 3,4 mm rear
 - 2,1 mm front

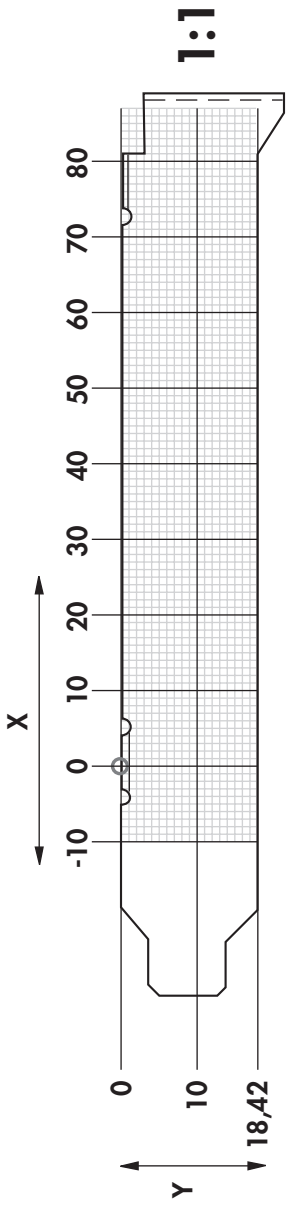

KHPC DESIGN

shape	X-dim.	Y-dim.	A	B	C	D	D1	E	F	G	H	I	J	K	L	M	N

company name:

part name:

drawing number: