

MINI UHF SERIES CONNECTORS & ADAPTERS

50 Ohm 0-2.5GHz

Mini-UHF coaxial connectors are popular and economical, they're used in applications from DC to 2.5 GHz and combine excellent electrical characteristics, small size and light weight at a relatively low priced for many coaxial applications. These miniature 3/8"-24 thread size connectors are provide excellent RF performance and impedance matched to 50 ohm cable, the Mini-UHF series are available crimp, twist-on and solder terminations.

Interface Dimensions:

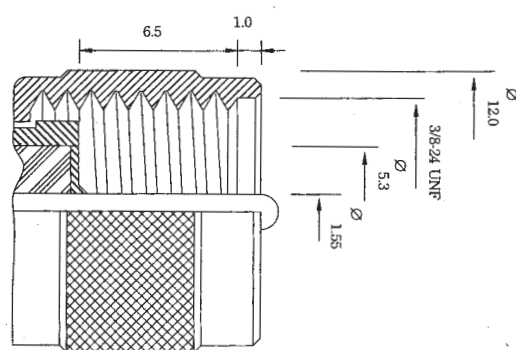

*Plug
(male)*

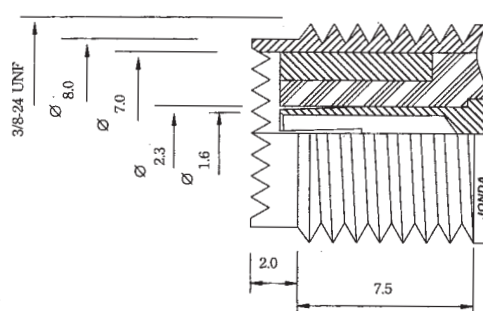

*Jack
(female)*

Electrical:

Impedance	50 ohm
Frequency Range	0 to 2.5 GHz
VSWR	1.25max GHz (Straight) ; 1.35max GHz (Right angle)

MINI UHF MALE CONNECTORS

MU551CU-*NG*50

MINI UHF PLUG CRIMP TYPE
RG58U, RG141U:

MU551CU-FNGD50

MU551CU-FNGT50

RG59U, RG62U:

MU551CU-GNGD50

MU551CU-GNGT50

RG174U, RG316U:

MU551CU-LNGD50

MU551CU-LNGT50

H155 CABLE:

MU551CU-U3NGD50

MU551CU-U3NGT50



MU571CU-XNG*50

MINI UHF QUCIK PLUG
CRIMP TYPE

RG58U, RG141U:

MU571CU-FNGD50

RG59U, RG62U:

MU571CU-GNGD50

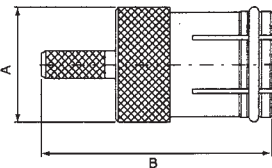

MU562CU-*NGD50

MINI UHF PLUG CRIMP TYPE
RG58U, RG141U:

MU562CU-FNGD50

RG59U, RG62U:

MU562CU-GNGD50



MU569CU-*NG*50

MINI UHF PLUG CRIMP
RIGHT ANGLE TYPE

RG58U, RG141U:

MU569CU-FNGD50

MU569CU-FNGT50

RG59U, RG62U:

MU569CU-GNGD50

MU569CU-GNGT50

RG174U, RG316U:

MU569CU-LNGD50

MU569CU-LNGT50

RG6U, RG5U:

MU569CU-ANGD50

MU569CU-ANGT50



MU565CU-*NG*50

MINI UHF PLUG
TWIST-ON TYPE

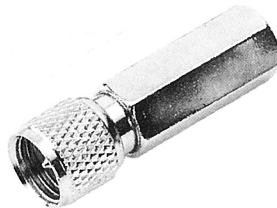

MU578CU-*NG*50

MINI UHF PLUG
TWIST ON TYPE

RG58U, RG141U:

MU578CU-FNG*50

RG59U, RG62U:

MU578CU-GNG*50

RG174U, RG316U:

MU578CU-LNG*50



MU579CU-XNG*50

MINI UHF PLUG CRIMP TYPE
RG58U, RG141U:

MU579CU-FNGD50

RG59U, RG62U:

MU579CU-GNGD50

RG6U, RG5U:

MU579CU-ANGD50

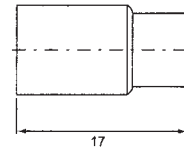
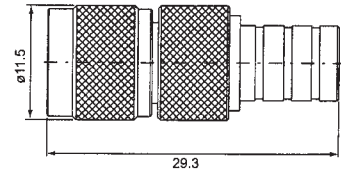

MU577CU-FNG*50

MINI UHF PLUG
TWIST ON TYPE
FOR RG58U CABLE

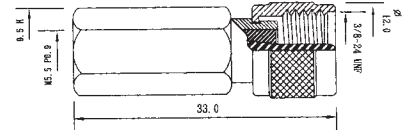

MINI UHF FEMALE CONNECTORS

MU552CU-*NG*50

MINI UHF JACK CRIMP TYPE
 RG58U, RG141U:
MU552CU-FNGD50
MU552CU-FNGT50
 RG59U, RG62U:
MU552CU-GNGD50
MU552CU-GNGT50
 RG174U, RG316U:
MU552CU-LNGD50
MU552CU-LNGT50
 H155 CABLE:
MU552CU-U3NGD50
MU552CU-U3NGT50



MU578CU-*NG*50

MINI UHF JACK CRIMP
 BULKHEAD TYPE
 RG58U, RG141U:
MU578CU-FNGD50
MU578CU-FNGT50
 RG59U, RG62U:
MU578CU-GNGD50
MU578CU-GNGT50
 RG174U, RG316U:
MU578CU-LNGD50
MU578CU-LNGT50
 RG179U, RG187U:
MU578CU-NNGD50
MU578CU-NNGT50



MU568CU-XNG*50

MINI UHF JACK SOLDER
 BULKHEAD TYPE
MU568CU-XNGD50
MU568CU-XNGT50



MU576ZN-XNGD50

MINI UHF JACK
 R/A PCB MOUNT TYPE

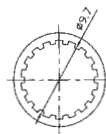
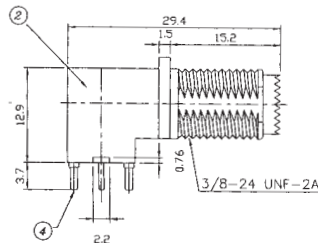

LOCK WASHER

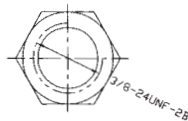

JAM NUT

MU564CU-XNG*50

MINI UHF JACK SOLDER
 PANEL MOUNT TYPE
MU564CU-XNGD50
MU564CU-XNGT50

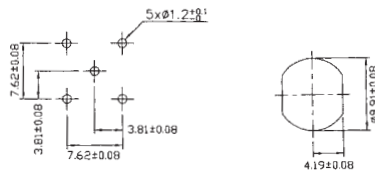

RECOMMENDED PCB LAYOUT

RECOMMEND PANEL CUTOUT

IN-SERIES & BETWEEN SERIES MINI UHF ADAPTERS (1)

MU553CU-X*50**
MINI UHF DOUBLE MALE



MU555CU-X*50**
MINI UHF MALE TO
MINI UHF FEMALE
RIGHT ANGLE TYPE

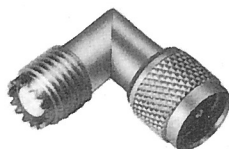

MU558CU-X*50**
MINI UHF MALE TO
SMA MALE



MU554CU-X*50**
MINI UHF DOUBLE FEMALE



MU590CU-XNGD50
MINI UHF FEMALE TO
TNC MALE



MU560CU-X*50**
MINI UHF MALE TO
SMA FEMALE



MU556CU-X*50**
MINI UHF MALE TO
MINI UHF DOUBLE FEMALE

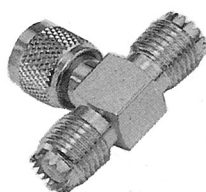

MU589CU-XNGD50
MINI UHF MALE TO
TNC FEMALE



MU559CU-X*50**
MINI UHF FEMALE TO
SMA MALE



MU557CU-X*50**
MINI UHF TRIPLE FEMALE



MU580CU-XGGD50
MINI UHF MALE TO
TNC MALE



MU561CU-X*50**
MINI UHF FEMALE TO
SMA FEMALE



IN-SERIES & BETWEEN SERIES MINI UHF ADAPTERS (2)

MU553CU-XNGD50
MINI UHF DOUBLE MALE



MU554CU-XNGD50
MINI UHF
DOUBLE FEMALE



MU575CU-X*50**
MINI UHF MALE TO
N MALE



MU586CU-XNGD50
MINI UHF DOUBLE MALE
RIGHT ANGLE TYPE

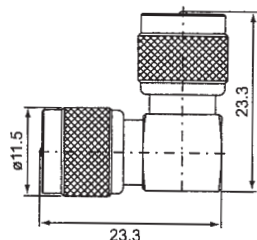

MU587CU-XNGD50
MINI UHF DOUBLE FEMALE
RIGHT ANGLE TYPE

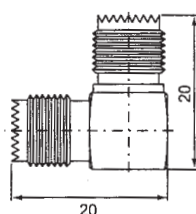

N339CU-X*50**
MINI UHF MALE TO
N FEMALE



MU556CU-XNGD50
MINI UHF MALE TO
MINI UHF DOUBLE FEMALE



MU588CU-XNGD50
MINI UHF DOUBLE FEMALE
BULKHEAD TYPE

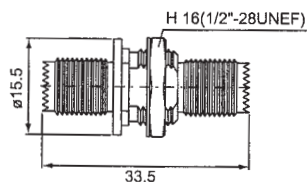

N340CU-X*50**
MINI UHF FEMALE TO
N MALE



MU555CU-XNGD50
MINI UHF FEMALE TO
MINI UHF MALE R/A TYPE



MU557CU-XNGD50
MINI UHF TRIPLE FEMALE



N364CU-X*50**
MINI UHF FEMALE TO
N FEMALE

