

结构说明 Structure

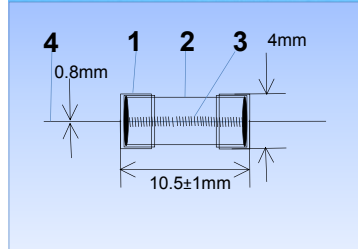
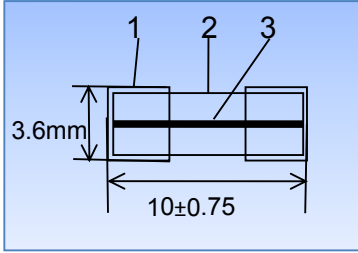

结构体 STRUCTURE		材质 MATERIAL	
1	金属帽 Ferrule	铜材镀镍 Electroless Nickel-cooper	
2	管体 Tube	玻璃管 Glass tube	
3	熔丝 Wire	合金 Metal	
4	焊接脚 Solder pin	镀锡铜线 Tinned wire	

额定电流 RATE CURRENT	额定电压 RATED VOLTAGE		安规认证 Safe authentication					
	125V	250V	UL	CUL	PSE	VDE	CQC	ROHS
250mA	●	●	●	●		●		●
315mA	●	●	●	●		●		●
500mA	●	●	●	●	●	●	●	●
630mA	●	●	●	●		●		●
800mA	●	●	●	●		●		●
1A	●	●	●	●	●	●	●	●
1.25A	●	●	●	●	●	●	●	●
1.5A	●	●	●	●				●
1.6A	●	●	●	●		●	●	●
2A	●	●	●	●	●	●	●	●
2.5A	●	●	●	●	●	●	●	●
3A	●	●	●	●		●	●	●
3.15A	●	●	●	●	●	●	●	●
3.5A	●	●	●	●	●			●
4A	●	●	●	●	●	●	●	●
5A	●	●	●	●		●	●	●
6A	●	●	●	●		●	●	●
6.3A	●	●	●	●	●	●	●	●
8A	●	●	●	●				●

电器性能 Electrical features

UL:248-1, UL248-13			IEC: 60127-1, GB:9364.3-1997		
Testing current 测试电流	Blow time limit 熔断时间		Testing current 测试电流	Blow time limit 熔断时间	
	Min 最小	Max 最大		Min 最小	Max 最大
100%	4 hour (小时)		100%	4 hour (小时)	
135%		1 hour (小时)	150%	1 hour (小时)	
200%		60sec(秒)	210%		30min(分钟)
1000%		20ms (毫秒)	1000%		20ms (毫秒)

UL跟VDE同时在一个产品上面的时候特性依照IEC60127执行标准为准, 符号为



标示。

结构说明 Structure

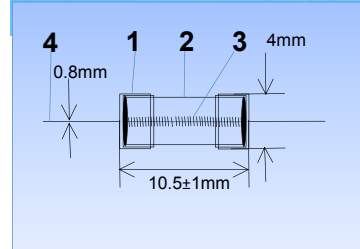
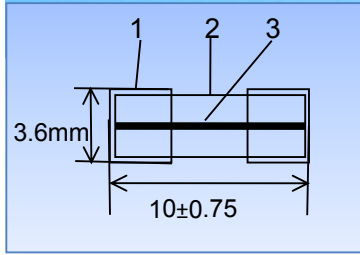

结构体 STRUCTURE		材质 MATERIAL	
1	金属帽 Ferrule	铜材镀镍 Electroless Nickel-cooper	
2	管体 Tube	玻璃管 Glass tube	
3	熔丝 Wire	合金 Metal	
4	焊接脚 Solder pin	镀锡铜线 Tinned wire	

额定电流 RATE CURRENT	额定电压 RATED VOLTAGE		安规认证 Safe authentication					
			UL	CUL	PSE	VDE	CQC	ROHS
250mA	125V	250V	●	●		●		●
315mA	125V	250V	●	●		●		●
500mA	125V	250V	●	●	●	●	●	●
630mA	125V	250V	●	●		●		●
800mA	125V	250V	●	●		●		●
1A	125V	250V	●	●	●	●	●	●
1.25A	125V	250V	●	●	●	●	●	●
1.5A	125V	250V	●	●	●			●
1.6A	125V	250V	●	●		●	●	●
2A	125V	250V	●	●	●	●	●	●
2.5A	125V	250V	●	●	●	●	●	●
3A	125V	250V	●	●	●		●	●
3.15A	125V	250V	●	●	●	●	●	●
3.5A	125V	250V	●	●	●	●		●
4A	125V	250V	●	●	●	●	●	●
5A	125V	250V	●	●	●	●	●	●
6A	125V	250V	●	●	●		●	●
6.3A	125V	250V	●	●	●	●	●	●
8A	125V	250V	●	●				●

电器性能 Electrical features

UL: 248-1, UL248-13			IEC: 60127-1, GB: 9364.3-1997		
Testing current 测试电流	Blow time limit 熔断时间		Testing current 测试电流	Blow time limit 熔断时间	
	Min 最小	Max 最大		Min 最小	Max 最大
100%	4 hour (小时)		100%	4 hour (小时)	
135%		1 hour (小时)	150%	1 hour (小时)	
200%		60sec(秒)	210%		120sec(秒)
1000%	20ms(毫秒)	200ms (毫秒)	1000%	20ms(毫秒)	200ms (毫秒)

UL跟VDE同时在一个产品上面的时候特性依照IEC60127执行标准为准, 符号为



标示。



3.6X10mm

陶瓷管保险丝(快断型) Ceramic Tube Fuse (Fast-Acting)



结构说明 Structure

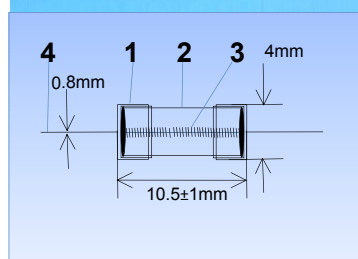
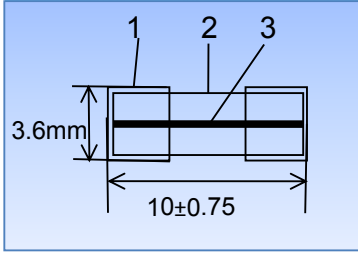

结构体 STRUCTURE			材质 MATERIAL	
1	金属帽	Ferrule	铜材镀镍	Electroless Nickel-cooper
2	管体	Ceramic	陶瓷管	Ceramic Tube
3	熔丝	Wire	合金	Metal
4	焊接脚	Solder pin	镀锡铜线	Tinned wire

额定电流 RATE CURRENT	额定电压 RATED VOLTAGE		安规认证 Safe authentication			
			UL	CUL	PSE	ROHS
250mA	250V	350V	●	●		●
315mA	250V	350V	●	●		●
500mA	250V	350V	●	●	●	●
630mA	250V	350V	●	●		●
800mA	250V	350V	●	●		●
1A	250V	350V	●	●	●	●
1.25A	250V	350V	●	●	●	●
1.5A	250V	350V	●	●	●	●
1.6A	250V	350V	●	●		●
2A	250V	350V	●	●	●	●
2.5A	250V	350V	●	●	●	●
3A	250V	350V	●	●	●	●
3.15A	250V	350V	●	●	●	●
3.5A	250V	350V	●	●	●	●
4A	250V	350V	●	●	●	●
5A	250V	350V	●	●	●	●
6A	250V	350V	●	●	●	●
6.3A	250V	350V	●	●	●	●
8A	250V	350V	●	●		●

电器性能 Electrical features

• UL:248-1, UL248-13

Testing current 测试电流	Blow time limit 熔断时间	
	Min 最小	Max 最大
100%	4 hour (小时)	
135%		1 hour (小时)
200%		60sec(秒)
1000%		20ms (毫秒)

结构说明 Structure

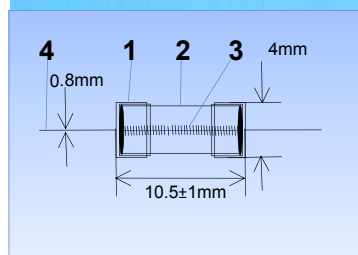
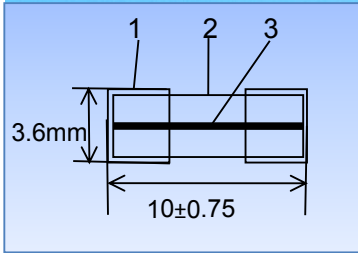

结构体 STRUCTURE		材质 MATERIAL	
1	金属帽 Ferrule	铜材镀镍 Electroless Nickel-cooper	
2	管体 Ceramic	陶瓷管 Ceramic Tube	
3	熔丝 Wire	合金 Metal	
4	焊接脚 Solder pin	镀锡铜线 Tinned wire	

额定电流 RATE CURRENT	额定电压 RATED VOLTAGE		安规认证 Safe authentication					
	125V	250V	UL	CUL	PSE	VDE	CQC	ROHS
250mA	●	●	●	●		●		●
315mA	●	●	●	●		●		●
500mA	●	●	●	●	●	●	●	●
630mA	●	●	●	●		●		●
800mA	●	●	●	●		●		●
1A	●	●	●	●	●	●	●	●
1.25A	●	●	●	●	●	●	●	●
1.5A	●	●	●	●	●			●
1.6A	●	●	●	●		●	●	●
2A	●	●	●	●	●	●	●	●
2.5A	●	●	●	●	●	●	●	●
3A	●	●	●	●	●		●	●
3.15A	●	●	●	●	●	●	●	●
3.5A	●	●	●	●	●			●
4A	●	●	●	●	●	●	●	●
5A	●	●	●	●	●	●	●	●
6A	●	●	●	●	●		●	●
6.3A	●	●	●	●	●	●	●	●
8A	●	●	●	●				●

电器性能 Electrical features

UL:248-1, UL248-13			IEC: 60127-1, GB:9364.3-1997		
Testing current 测试电流	Blow time limit 熔断时间		Testing current 测试电流	Blow time limit 熔断时间	
	Min 最小	Max 最大		Min 最小	Max 最大
100%	4 hour (小时)		100%	4 hour (小时)	
150%		1 hour (小时)	150%	1 hour (小时)	
210%		60sec(秒)	210%		120sec(秒)
1000%	20ms(毫秒)	200ms (毫秒)	1000%	20ms(毫秒)	200ms (毫秒)

UL跟VDE同时在一个产品上面的时候特性依照IEC60127执行标准为准, 符号为



标示。

结构说明 Structure

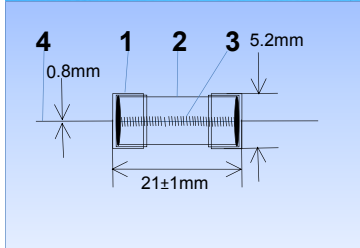
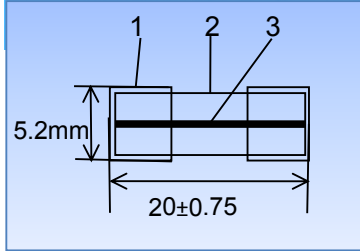

结构体 STRUCTURE			材质 MATERIAL	
1	金属帽 Ferrule	Ferrule	铜材镀镍 Electroless Nickel-cooper	
2	管体 Tube	Tube	玻璃管 Glass tube	
3	熔丝 Wire	Wire	合金 Metal	
4	焊接脚 Solder pin	Solder pin	镀锡铜线 Tinned wire	

额定电流 RATE CURRENT	额定电压 RATED VOLTAGE		安规认证 Safe authentication					
	125V	250V	UL	CUL	PSE	VDE	CQC	ROHS
250mA	●	●	●	●		●		●
315mA	●	●	●	●		●		●
500mA	●	●	●	●	●	●	●	●
630mA	●	●	●	●		●		●
800mA	●	●	●	●		●		●
1A	●	●	●	●	●	●	●	●
1.25A	●	●	●	●	●	●	●	●
1.5A	●	●	●	●	●			●
1.6A	●	●	●	●		●	●	●
2A	●	●	●	●	●	●	●	●
2.5A	●	●	●	●	●	●	●	●
3A	●	●	●	●	●		●	●
3.15A	●	●	●	●	●	●	●	●
3.5A	●	●	●	●	●	●		●
4A	●	●	●	●	●	●	●	●
5A	●	●	●	●	●	●	●	●
6A	●	●	●	●	●		●	●
6.3A	●	●	●	●	●	●	●	●
8A	●	●	●	●				●

电器性能 Electrical features

UL:248-1, UL248-13			IEC: 60127-1, GB:9364.3-1997		
Testing current 测试电流	Blow time limit 熔断时间		Testing current 测试电流	Blow time limit 熔断时间	
	Min 最小	Max 最大		Min 最小	Max 最大
100%	4 hour (小时)		100%	4 hour (小时)	
135%		1 hour (小时)	150%	1 hour (小时)	
200%		120sec(秒)	210%		30min(分钟)
1000%		20ms (毫秒)	1000%		20ms (毫秒)

UL跟VDE同时在一个产品上面的时候特性依照IEC60127执行标准为准, 符号为 标示。

结构说明 Structure

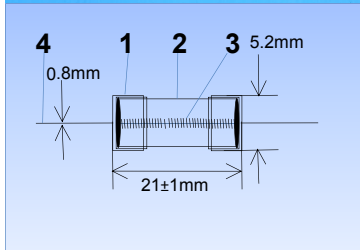
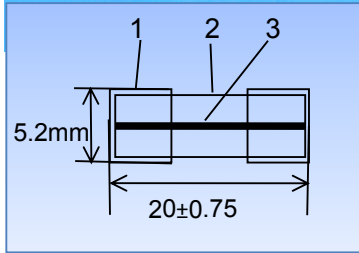

结构体 STRUCTURE			材质 MATERIAL	
1	金属帽	Ferrule	铜材镀镍	Electroless Nickel-cooper
2	管体	Tube	玻璃管	Glass tube
3	熔丝	Wire	合金	Metal
4	焊接脚	Solder pin	镀锡铜线	Tinned wire

额定电流 RATE CURRENT	额定电压 RATED VOLTAGE		安规认证 Safe authentication					
	125V	250V	UL	CUL	PSE	VDE	CQC	ROHS
250mA	●	●	●	●		●		●
315mA	●	●	●	●		●		●
500mA	●	●	●	●	●	●	●	●
630mA	●	●	●	●		●		●
800mA	●	●	●	●		●		●
1A	●	●	●	●	●	●	●	●
1.25A	●	●	●	●	●	●	●	●
1.5A	●	●	●	●	●			●
1.6A	●	●	●	●		●	●	●
2A	●	●	●	●	●	●	●	●
2.5A	●	●	●	●	●	●	●	●
3A	●	●	●	●	●		●	●
3.15A	●	●	●	●	●	●	●	●
3.5A	●	●	●	●	●	●		●
4A	●	●	●	●	●	●	●	●
5A	●	●	●	●	●	●	●	●
6A	●	●	●	●	●		●	●
6.3A	●	●	●	●	●	●	●	●
8A	●	●	●	●				●

电器性能 Electrical features

UL:248-1, UL248-13			IEC: 60127-1, GB:9364.3-1997		
Testing current 测试电流	Blow time limit 熔断时间		Testing current 测试电流	Blow time limit 熔断时间	
	Min 最小	Max 最大		Min 最小	Max 最大
100%	4 hour (小时)		100%	4 hour (小时)	
150%	1 hour (小时)		150%	1 hour (小时)	
210%		120sec(秒)	210%		120sec(秒)
1000%	20ms(毫秒)	200ms (毫秒)	1000%	20ms(毫秒)	200ms (毫秒)

UL跟VDE同时在一个产品上面的时候特性依照IEC60127执行标准为准, 符号为 标示。

结构说明 Structure

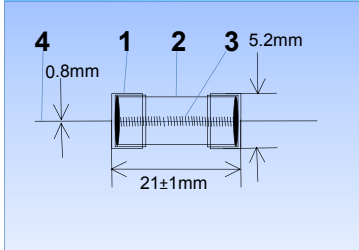
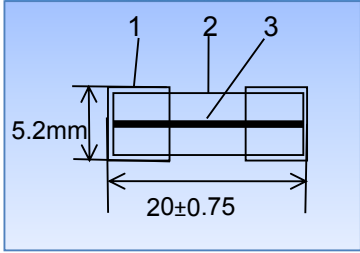

结构体 STRUCTURE			材质 MATERIAL	
1	金属帽	Ferrule	铜材镀镍	Electroless Nickel-cooper
2	管体	Tube	陶瓷管	Ceramic Tube
3	熔丝	Wire	合金	Metal
4	焊接脚	Solder pin	镀锡铜线	Tinned wire

额定电流 RATE CURRENT	额定电压 RATED VOLTAGE		安规认证 Safe authentication						
	125V	250V	500V	UL	CUL	PSE	VDE	CQC	ROHS
250mA	125V	250V		●	●		●		●
315mA	125V	250V		●	●		●		●
500mA	125V	250V	500V	●	●	●	●	●	●
630mA	125V	250V		●	●		●	●	●
800mA	125V	250V	500V	●	●		●	●	●
1A	125V	250V	500V	●	●	●	●	●	●
1.25A	125V	250V		●	●	●	●	●	●
1.5A	125V	250V		●	●	●	●		●
1.6A	125V	250V		●	●		●	●	●
2A	125V	250V	500V	●	●	●	●	●	●
2.5A	125V	250V		●	●	●	●		●
3.15A	125V	250V	500V	●	●	●	●	●	●
3.5A	125V	250V		●	●	●	●		●
4A	125V	250V	500V	●	●	●	●	●	●
5A	125V	250V	500V	●	●	●	●	●	●
6.3A	125V	250V	500V	●	●	●	●	●	●
8A	125V	250V	500V	●	●	●	●	●	●
10A	125V	250V	500V	●	●	●	●	●	●

电器性能 Electrical features

UL:248-1, UL248-13			IEC: 60127-2, GB:9364.3-1997		
Testing current 测试电流	Blow time limit 熔断时间		Testing current 测试电流	Blow time limit 熔断时间	
	Min 最小	Max 最大		Min 最小	Max 最大
100%	4 hour (小时)		100%	4 hour (小时)	
135%		1 hour (小时)	150%	1 hour (小时)	
200%		60sec(秒)	210%		30min(分钟)
1000%		20ms (毫秒)	1000%		20ms (毫秒)

UL跟VDE同时在一个产品上面的时候特性依照IEC60127执行标准为准, 符号为



标示。

结构说明 Structure

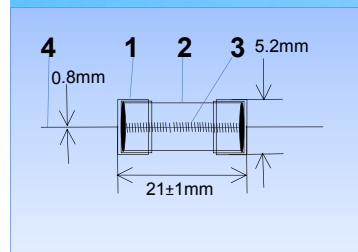
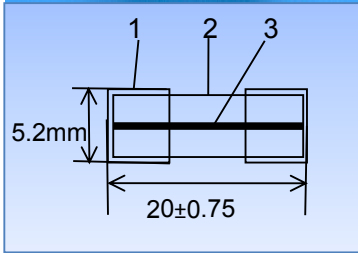

结构体 STRUCTURE		材质 MATERIAL	
1	金属帽 Ferrule	铜材镀镍 Electroless Nickel-cooper	
2	管体 Tube	陶瓷管 Ceramic Tube	
3	熔丝 Wire	合金 Metal	
4	焊接脚 Solder pin	镀锡铜线 Tinned wire	

额定电流 RATE CURRENT	额定电压 RATED VOLTAGE		安规认证 Safe authentication						
			UL	CUL	PSE	VDE	CQC	ROHS	
250mA	125V	250V		●	●		●		●
315mA	125V	250V		●	●		●		●
500mA	125V	250V	500V	●	●	●	●	●	●
630mA	125V	250V		●	●		●	●	●
800mA	125V	250V	500V	●	●		●	●	●
1A	125V	250V	500V	●	●	●	●	●	●
1.25A	125V	250V		●	●	●	●	●	●
1.5A	125V	250V		●	●	●	●		●
1.6A	125V	250V		●	●		●	●	●
2A	125V	250V	500V	●	●	●	●	●	●
2.5A	125V	250V		●	●	●	●		●
3.15A	125V	250V	500V	●	●	●	●	●	●
3.5A	125V	250V		●	●	●	●		●
4A	125V	250V	500V	●	●	●	●	●	●
5A	125V	250V	500V	●	●	●	●	●	●
6.3A	125V	250V	500V	●	●	●	●	●	●
8A	125V	250V	500V	●	●	●	●	●	●
10A	125V	250V	500V	●	●	●	●	●	●

电器性能 Electrical features

UL:248-1, UL248-13			IEC: 60127-2, GB:9364.3-1997		
Testing current 测试电流	Blow time limit 熔断时间		Testing current 测试电流	Blow time limit 熔断时间	
	Min 最小	Max 最大		Min 最小	Max 最大
100%	4 hour (小时)		100%	4 hour (小时)	
135%		1 hour (小时)	150%	1 hour (小时)	
200%		60sec(秒)	210%		2min(分钟)
1000%		20ms (毫秒)	1000%	20ms (毫秒)	200ms (毫秒)

UL跟VDE同时在一个产品上面的时候特性依照IEC60127执行标准为准, 符号为



标示。



6.35X31.75mm

玻璃管保险丝(快断型) Glass Tube Fuse (Fast-Acting)

RoHS



结构说明 Structure

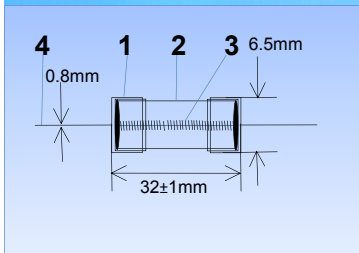
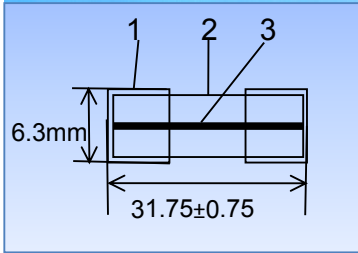
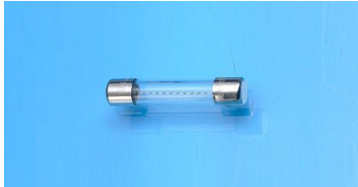

结构体 STRUCTURE		材质 MATERIAL	
1	金属帽 Ferrule	铜材镀镍 Electroless Nickel-cooper	
2	管体 Tube	玻璃管 Glass tube	
3	熔丝 Wire	合金 Metal	
4	焊接脚 Solder pin	镀锡铜线 Tinned wire	

额定电流 RATE CURRENT	额定电压 RATED VOLTAGE			安规认证 Safe authentication			
				UL	CUL	PSE	ROHS
250mA		125V	250V	●	●		●
350mA		125V	250V	●	●		●
500mA		125V	250V	●	●	●	●
750mA		125V	250V	●	●		●
800mA		125V	250V	●	●		●
1A	32V	125V	250V	●	●	●	●
1.25A		125V	250V	●	●	●	●
1.6A		125V	250V	●	●	●	●
2A	32V	125V	250V	●	●		●
2.5A		125V	250V	●	●	●	●
3A	32V	125V	250V	●	●	●	●
5A	32V	125V	250V	●	●	●	●
6A	32V	125V	250V	●	●	●	●
7A	32V	125V	250V	●	●	●	●
8A	32V	125V	250V	●	●	●	●
10A	32V	125V	250V	●	●	●	●
12A	32V	125V	250V	●	●	●	●
15A	32V	125V	250V	●	●		●
20A	32V	125V	250V	●	●		●
25A	32V	125V	250V	●	●		●
30A	32V	125V	250V				●

电器性能 Electrical features

• UL:248-1, UL248-14

Testing current 测试电流	Blow time limit 熔断时间	
	Min 最小	Max 最大
100%	4 hour (小时)	
200%		60sec(秒)

32V/DC, QC/T420-2004

结构说明 Structure

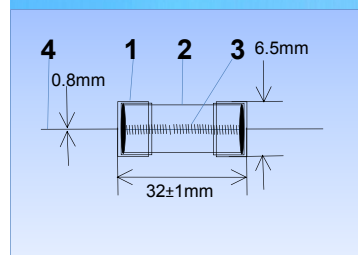
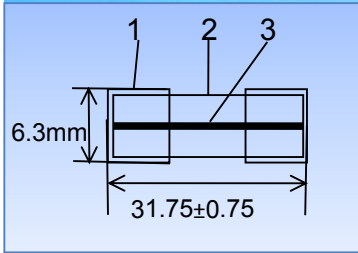
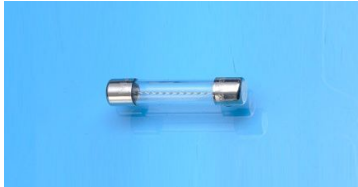

结构体 STRUCTURE		材质 MATERIAL	
1	金属帽 Ferrule	铜材镀镍 Electroless Nickel-cooper	
2	管体 Tube	玻璃管 Glass Tube	
3	熔丝 Wire	合金 Metal	
4	焊接脚 Solder pin	镀锡铜线 Tinned wire	

额定电流 RATE CURRENT	额定电压 RATED VOLTAGE		安规认证 Safe authentication			
			UL	CUL	PSE	ROHS
250mA	125V	250V	●	●		●
350mA	125V	250V	●	●		●
500mA	125V	250V	●	●	●	●
750mA	125V	250V	●	●		●
800mA	125V	250V	●	●		●
1A	125V	250V	●	●	●	●
1.25A	125V	250V	●	●	●	●
1.6A	125V	250V	●	●	●	●
2A	125V	250V	●	●		●
2.5A	125V	250V	●	●	●	●
3A	125V	250V	●	●	●	●
5A	125V	250V	●	●	●	●
6A	125V	250V	●	●	●	●
7A	125V	250V	●	●	●	●
8A	125V	250V	●	●	●	●
10A	125V	250V	●	●	●	●
12A	125V	250V	●	●	●	●
15A	125V	250V	●	●	●	●
20A	125V	250V	●	●		●
25A	125V	250V	●	●		●

电器性能 Electrical features

- UL:248-1 , UL248-14

Testing current 测试电流	Blow time limit 熔断时间	
	Min 最小	Max 最大
100%	4 hour (小时)	
200%		60sec(秒)
1000%	20ms (毫秒)	200ms (毫秒)



6.35X31.75mm

陶瓷管保险丝(快断型)

Ceramic Tube Fuse (Fast-Acting)

RoHS



结构说明 Structure

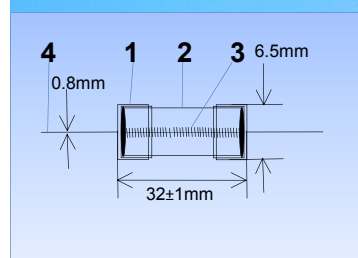
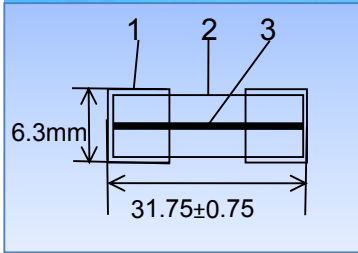

结构体 STRUCTURE			材质 MATERIAL	
1	金属帽	Ferrule	铜材镀镍	Electroless Nickel-cooper
2	管体	Tube	陶瓷管	Ceramic Tube
3	熔丝	Wire	合金	Metal
4	焊接脚	Solder pin	镀锡铜线	Tinned wire

额定电流 RATE CURRENT	额定电压 RATED VOLTAGE			安规认证 Safe authentication			
				UL	CUL	PSE	ROHS
250mA	125V	250V		●	●		●
350mA	125V	250V		●	●		●
500mA	125V	250V	500V	●	●	●	●
750mA	125V	250V		●	●		●
800mA	125V	250V		●	●		●
1A	125V	250V	500V	●	●	●	●
1.25A	125V	250V		●	●	●	●
1.6A	125V	250V	500V	●	●	●	●
2A	125V	250V	500V	●	●		●
2.5A	125V	250V		●	●	●	●
3A	125V	250V	500V	●	●	●	●
5A	125V	250V	500V	●	●	●	●
6A	125V	250V		●	●	●	●
7A	125V	250V		●	●	●	●
8A	125V	250V	500V	●	●	●	●
10A	125V	250V	500V	●	●	●	●
12A	125V	250V	500V	●	●	●	●
15A	125V	250V	500V	●	●		●
20A	125V	250V		●	●		●
25A	125V	250V		●	●		●

电器性能 Electrical features

• UL:248-1, UL248-14

Testing current 测试电流	Blow time limit 熔断时间	
	Min 最小	Max 最大
100%	4 hour (小时)	
200%		60sec(秒)

500V只有通过UL认证, 分断能力AC500V 1000A

结构说明 Structure

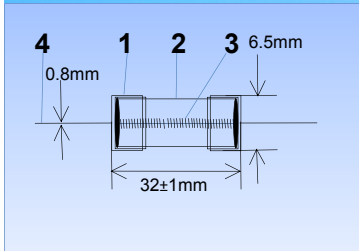
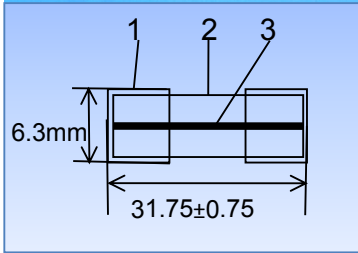

结构体 STRUCTURE		材质 MATERIAL	
1	金属帽 Ferrule	铜材镀镍 Electroless Nickel-cooper	
2	管体 Tube	陶瓷管 Ceramic Tube	
3	熔丝 Wire	合金 Metal	
4	焊接脚 Solder pin	镀锡铜线 Tinned wire	

额定电流 RATE CURRENT	额定电压 RATED VOLTAGE		安规认证 Safe authentication			
			UL	CUL	PSE	ROHS
250mA	125V	250V	●	●		●
350mA	125V	250V	●	●		●
500mA	125V	250V	●	●	●	●
750mA	125V	250V	●	●		●
800mA	125V	250V	●	●		●
1A	125V	250V	●	●	●	●
1.25A	125V	250V	●	●	●	●
1.6A	125V	250V	●	●	●	●
2A	125V	250V	●	●		●
2.5A	125V	250V	●	●	●	●
3A	125V	250V	●	●	●	●
5A	125V	250V	●	●	●	●
6A	125V	250V	●	●	●	●
7A	125V	250V	●	●	●	●
8A	125V	250V	●	●	●	●
10A	125V	250V	●	●	●	●
12A	125V	250V	●	●	●	●
15A	125V	250V	●	●	●	●
20A	125V	250V	●	●		●
25A	125V	250V	●	●		●

电器性能 Electrical features

- UL:248-1, UL248-14

Testing current 测试电流	Blow time limit 熔断时间	
	Min 最小	Max 最大
100%	4 hour (小时)	
200%		60sec(秒)
1000%	20ms (毫秒)	200ms (毫秒)



6.35X25mm

BS1362 英式插头保险丝
British Plug Fuse BS1362



结构说明 Structure

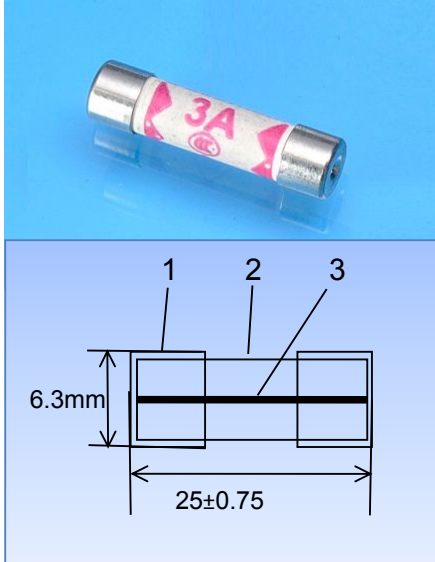

结构体 STRUCTURE		材质 MATERIAL	
1	金属帽 Ferrule	铜材镀镍 Electroless Nickel-cooper	
2	管体 Tube	陶瓷管 Ceramic Tube	
3	熔丝 Wire	合金 Metal	

额定电流 RATE CURRENT	额定电压 RATED VOLTAGE	安规认证 Safe authentication			
		ASTA	BSI	CCC	ROHS
2A	250V	●	●	●	●
3A	250V	●	●	●	●
5A	250V	●	●	●	●
7A	250V	●	●	●	●
10A	250V	●	●	●	●
13A	250V	●	●	●	●

Electrical features

• 执行标准 Standard: BS1362:1973

Testing current 测试电流	Blow time limit 熔断时间	
	Min 最小	Max 最大
100%	1000hour (小时)	
160%		30min(分钟)
190%		30sec (秒)

• 1/4" x 1" fast/medium British plug fuse.

• Weight: 2.25g ± 0.15g (2A to 13A inclusive)

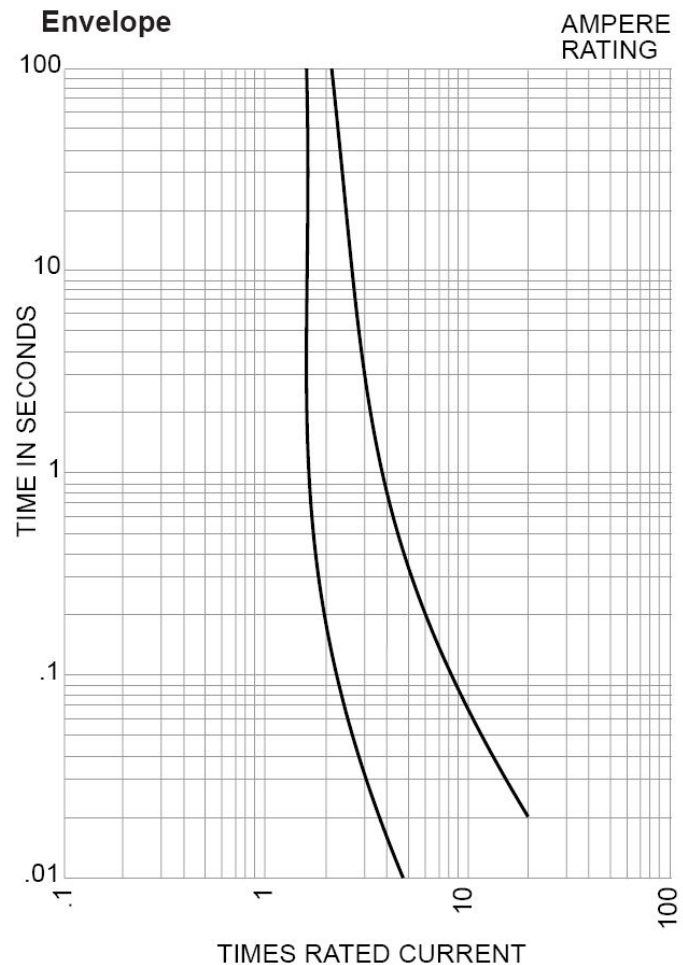

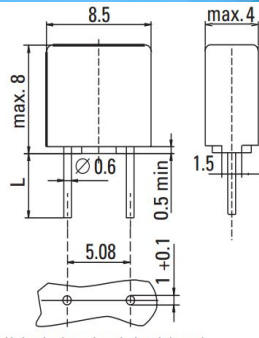
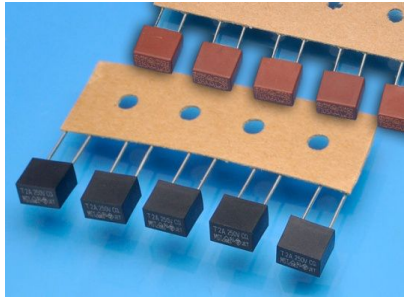

Holes in the printed circuit board

Long Leads (L=18.8mm)
Short Leads (L=4.3mm)

Agency Approvals

VDE	50mA-6.3A
CSA	50mA-6.3A
UL	50mA-6.3A
KC	50mA-6.3A
SEMKO	50mA-6.3A
CCC	50mA-6.3A

Interrupting Rating

35 amperes or 10 × rated current ;
whichever is greater at 250V AC.

电器性能 Electrical features

Rated current	1.5In	2.1In	2.75In		400In		1000In	
	MIN	MAX	MIN	MAX	MIN	MAX	MIN	MAX
50mA-5A	60 Min	2 Min	400 Ms	10 sec	150 ms	3 sec	20 ms	150 Ms
6.3A	60 Min	2 Min	400 Ms	10 sec	150 Ms	3 sec	15 ms	150 Ms

standard: IEC 60127-3

RATE CURRENT	RATED VOLTAGE	Nominal Resistance Cold Ohms	Voltage Drop (mv)MAX	Nominal MeltingI ² T A ² Sec
50mA	250V	6.8470	550	0.020000
63mA		4.6550	500	0.027700
80mA		2.8730	400	0.030000
100mA		2.1170	350	0.040000
125mA		1.2560	300	0.080000
160mA		0.8230	250	0.150000
200mA		0.5960	250	0.260000
250mA		0.4050	220	0.470000
315mA		0.2670	200	0.770000
400mA		0.2000	180	1.20000
500mA		0.1770	170	1.950000
630mA		0.1270	160	3.100000
800mA		0.1260	150	5.100000
1A		0.0650	140	7.800000
1.25A		0.0500	130	12.50000
1.6A		0.0370	120	20.00000
2A	0.0300	100	32.00000	
2.5A	0.0220	100	49.00000	
3.15A	0.0170	100	126.00000	
4A	0.0120	100	198.50000	
5A	0.0091	100	315.00000	
6.3A	0.0071	100		

耐久测试 Endurance test

通过额定电流值100%(亦即 1.0 x In A)1.5小时后, 保险丝的表面温度不应超过75度。
Loaded with the 100% nominal current (or 1.0 x, A) for 1.5 hours, fuse surface temperature should not exceed 75 celsius degrees.



Subminiature Fuses

圆柱形 (延时型) 保险丝 Cylinder (Time-Delay) Fuse

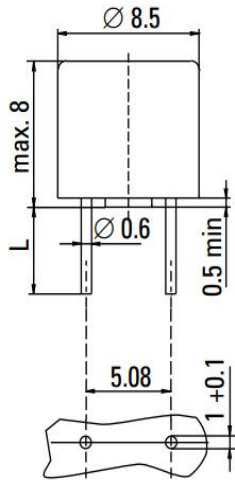
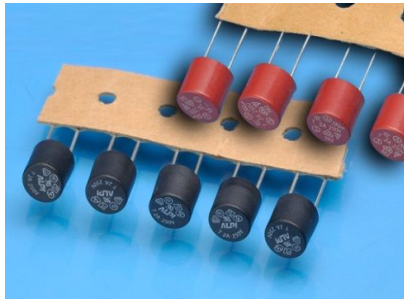

Holes in PCB

Long Leads (L=18.8mm)
Short Leads (L=4.3mm)

Agency Approvals

VDE	50mA-6.3A
CSA	50mA-6.3A
UL	50mA-6.3A
KC	50mA-6.3A
SEMKO	50mA-6.3A
CCC	50mA-6.3A

Interrupting Rating

35 amperes or 10 × rated current ;
whichever is greater at 250V AC.

电器性能 Electrical features

Rated current	1.5In		2.1In		2.75In		400In		1000In	
	MIN	MAX	MIN	MAX	MIN	MAX	MIN	MAX	MIN	MAX
50mA-5A	60 Min	2 Min	400 Ms	10 sec	150 ms	3 sec	20 ms	150 Ms		
6.3A	60 Min	2 Min	400 Ms	10 sec	150 ms	3 sec	15 ms	150 Ms		

执行标准: IEC 60127-3

RATED CURRENT	RATED VOLTAGE	Nominal Resistance Cold Ohms	Voltage Drop (mv)MAX	Nominal Melting I ² T A ² Sec
50mA	250V	6.8470	550	0.020000
63mA		4.6550	500	0.027700
80mA		2.8730	400	0.030000
100mA		2.1170	350	0.040000
125mA		1.2560	300	0.080000
160mA		0.8230	250	0.150000
200mA		0.5960	250	0.260000
250mA		0.4050	220	0.470000
315mA		0.2670	200	0.770000
400mA		0.2000	180	1.20000
500mA		0.1770	170	1.950000
630mA		0.1270	160	3.100000
800mA		0.1260	150	5.100000
1A		0.0650	140	7.800000
1.25A		0.0500	130	12.50000
1.6A		0.0370	120	20.00000
2A		0.0300	100	32.00000
2.5A		0.0220	100	49.00000
3.15A		0.0170	100	126.00000
4A		0.0120	100	198.50000
5A	0.0091	100	315.00000	
6.3A	0.0071	100		

耐久测试 Endurance test

通过额定电流值100% (亦即 1.0 x In A) 1.5小时后, 保险丝的表面温度不应超过75度。
Loaded with the 100% nominal current (or 1.0 x, A) for 1.5 hours, fuse surface temperature should not exceed 75 celsius degrees.



Subminiature Fuses

圆柱形 (快断型) 保险丝 Cylinder (Fast-Acting) Fuse

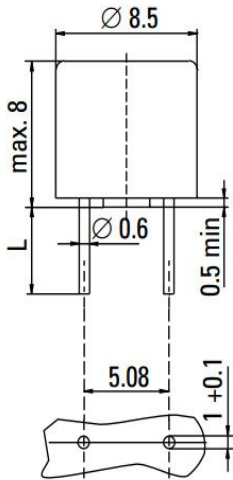
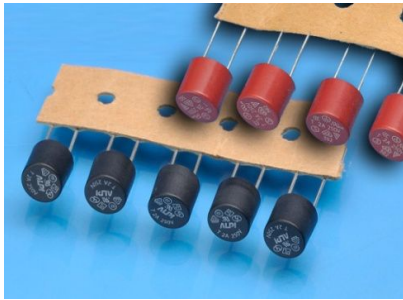

Holes in PCB

Long Leads (L=18.8mm)
Short Leads (L=4.3mm)

Agency Approvals

VDE	50mA-6.3A
CSA	50mA-6.3A
UL	50mA-6.3A
KC	50mA-6.3A
SEMKO	50mA-6.3A
CCC	50mA-6.3A

Interrupting Rating

35 amperes or 10 × rated current ;
whichever is greater at 250V AC.

电器性能 Electrical features

Rated	1.5In	2.1In	2.75In		400In		1000In	
current	MIN	MAX	MIN	MAX	MIN	MAX	MIN	MAX
50mA-5A	60 Min	30 Min	10 Ms	3 Sec	3 Ms	3 Ms		20 Ms
6.3A	60 Min	30 Min	10 Ms	3 Sec	3 Ms	3 Ms		20 Ms

执行标准: IEC 60127-3

RATED CURRENT	RATED VOLTAGE	Nominal Resistance Cold Ohms	Voltage Drop (mv)MAX	Nominal Melting I ² T A ² Sec
50mA	250V	6.8470	550	0.020000
63mA		4.6550	500	0.027700
80mA		2.8730	400	0.030000
100mA		2.1170	350	0.040000
125mA		1.2560	300	0.080000
160mA		0.8230	250	0.150000
200mA		0.5960	250	0.260000
250mA		0.4050	220	0.470000
315mA		0.2670	200	0.770000
400mA		0.2000	180	1.20000
500mA		0.1770	170	1.950000
630mA		0.1270	160	3.100000
800mA		0.1260	150	5.100000
1A		0.0650	140	7.800000
1.25A		0.0500	130	12.50000
1.6A		0.0370	120	20.00000
2A		0.0300	100	32.00000
2.5A	0.0220	100	49.00000	
3.15A	0.0170	100	126.00000	
4A	0.0120	100	198.50000	
5A	0.0091	100	315.00000	
6.3A	0.0071	100		

耐久测试 Endurance test

通过额定电流值100%(亦即 1.0 x In A)1.5小时后, 保险丝的表面温度不应超过75度。
Loaded with the 100% nominal current (or 1.0 x, A) for 1.5 hours, fuse surface temperature should not exceed 75 celsius degrees.

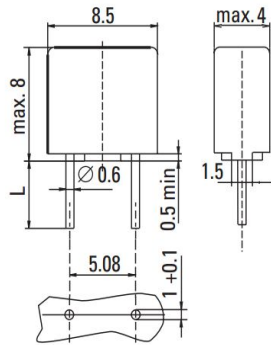
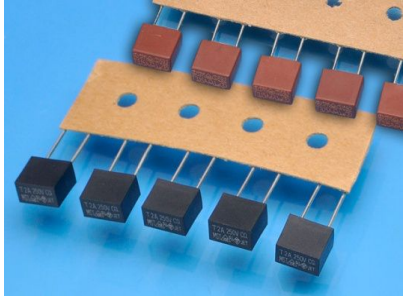

Holes in the printed circuit board

Long Leads (L=18.8mm)
Short Leads (L=4.3mm)

电器性能 Electrical features

Rated current	1.5In	2.1In	2.75In		400In		1000In	
	MIN	MAX	MIN	MAX	MIN	MAX	MIN	MAX
50mA-5A	60 Min	30 Min	10 Ms	3 Sec	3 Ms	300 Ms		20 Ms
6.3A	60 Min	30 Min	10 Ms	3 Sec	3 Ms	300 Ms		20 Ms

执行标准: IEC 60127-3

RATED CURRENT	RATED VOLTAGE	Nominal Resistance Cold Ohms	Voltage Drop (mv)MAX	Nominal Melting I ² T A ² Sec
50mA	250V	6.8470	550	0.020000
63mA		4.6550	500	0.027700
80mA		2.8730	400	0.030000
100mA		2.1170	350	0.040000
125mA		1.2560	300	0.080000
160mA		0.8230	250	0.150000
200mA		0.5960	250	0.260000
250mA		0.4050	220	0.470000
315mA		0.2670	200	0.770000
400mA		0.2000	180	1.20000
500mA		0.1770	170	1.950000
630mA		0.1270	160	3.100000
800mA		0.1260	150	5.100000
1A		0.0650	140	7.800000
1.25A		0.0500	130	12.50000
1.6A		0.0370	120	20.00000
2A	0.0300	100	32.00000	
2.5A	0.0220	100	49.00000	
3.15A	0.0170	100	126.0000	
4A	0.0120	100	198.5000	
5A	0.0091	100	315.0000	
6.3A	0.0071	100		

Agency Approvals

VDE	50mA-6.3A
CSA	50mA-6.3A
UL	50mA-6.3A
KC	50mA-6.3A
SEMKO	50mA-6.3A
CCC	50mA-6.3A

Interrupting Rating

35 amperes or 10 × rated current ;
whichever is greater at 250V AC.

耐久测试 Endurance test

通过额定电流值100%(亦即 1.0 x In A)1.5小时后, 保险丝的表面温度不应超过75度。

Loaded with the 100% nominal current (or 1.0 x, A) for 1.5 hours, fuse surface temperature should not exceed 75 celsius degrees.



3x8mm

电阻式保险丝(快断型) Pico Fuse (Fast-Acting)

RoHS



结构说明 Structure

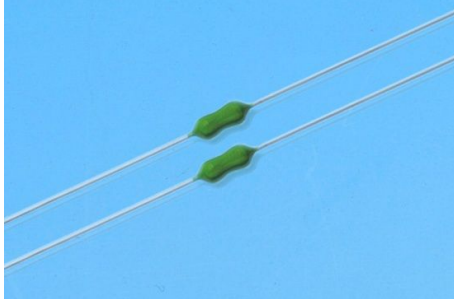

结构体 STRUCTURE		材质 MATERIAL	
A	管体 Tube	玻璃管 Glass tube	
B	熔丝 Wire	合金 Metal	
C	焊接脚 Solder pin	镀锡铜线 Tinned wire	
D	本体封装 Surface	环氧树脂 Epoxy-Coated Body	
E	金属帽 Ferrule	铜材镀镍 Electroless Nickel-copper	

电器性能 Electrical features

Testing current 测试电流	Blow time limit 熔断时间	
	Min 最小	Max 最大
100%	4 hour (小时)	
200%		60sec(秒)

执行标准: UL248-1, UL248-14

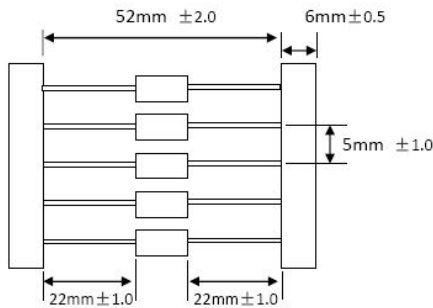
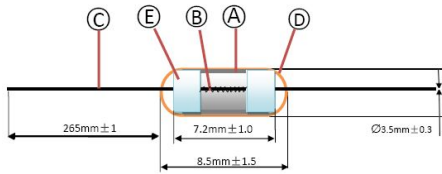

额定电流 RATE CURRENT	额定电压 RATED VOLTAGE		安规认证 Safe authentication			
			UL	CUL	PSE	ROHS
250mA	250V	350V	●	●		●
315mA	250V	350V	●	●		●
500mA	250V	350V	●	●	●	●
630mA	250V	350V	●	●		●
800mA	250V	350V	●	●		●
1A	250V	350V	●	●	●	●
1.25A	250V	350V	●	●	●	●
1.5A	250V	350V	●	●	●	●
1.6A	250V	350V	●	●		●
2A	250V	350V	●	●	●	●
2.5A	250V	350V	●	●	●	●
3A	250V	350V	●	●	●	●
3.15A	250V	350V	●	●	●	●
3.5A	250V	350V	●	●	●	●
4A	250V	350V	●	●	●	●
5A	250V	350V	●	●	●	●
6A	250V	350V	●	●	●	●
6.3A	250V	350V	●	●	●	●
8A	250V	350V	●	●		●

耐久测试 Endurance test

通过额定电流值100%(亦即 1.0 x In A)1.5小时后, 保险丝的表面温度不应超过75度。
Loaded with the 100% nominal current (or 1.0 x, A) for 1.5 hours, fuse surface temperature should not exceed 75 celsius degrees.



3x8mm

电阻式保险丝(延时型) Pico Fuse (Time-Delay)

RoHS



结构说明 Structure

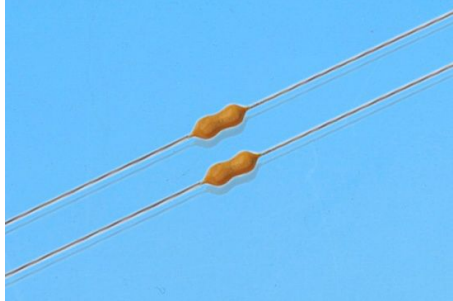

结构体 STRUCTURE	材质 MATERIAL			
A 管体 Tube	玻璃管 Glass tube			
B 熔丝 Wire	合金 Metal			
C 焊接脚 Solder pin	镀锡铜线 Tinned wire			
D 本体封装 Surface	环氧树脂 Epoxy-Coated Body			
E 金属帽 Ferrule	铜材镀镍 Electroless Nickel-cooper			

电器性能 Electrical features

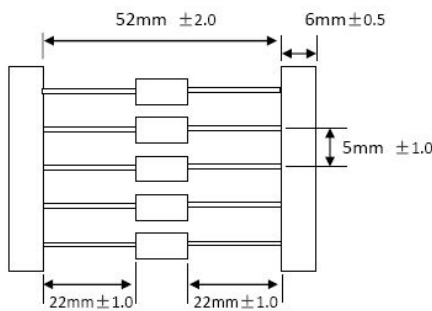
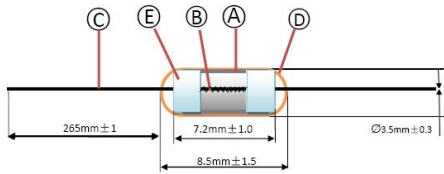

Testing current 测试电流	Blow time limit 熔断时间	
	Min 最小	Max 最大
100%	4 hour (小时)	
200%		60sec(秒)
1000%	10ms(毫秒)	200MS(毫秒)

额定电流 RATE CURRENT	额定电压 RATED VOLTAGE		安规认证 Safe authentication			
			UL	CUL	PSE	ROHS
250mA	250V	350V	●	●		●
315mA	250V	350V	●	●		●
500mA	250V	350V	●	●	●	●
630mA	250V	350V	●	●		●
800mA	250V	350V	●	●		●
1A	250V	350V	●	●	●	●
1.25A	250V	350V	●	●	●	●
1.5A	250V	350V	●	●	●	●
1.6A	250V	350V	●	●		●
2A	250V	350V	●	●	●	●
2.5A	250V	350V	●	●	●	●
3A	250V	350V	●	●	●	●
3.15A	250V	350V	●	●	●	●
3.5A	250V	350V	●	●	●	●
4A	250V	350V	●	●	●	●
5A	250V	350V	●	●	●	●
6A	250V	350V	●	●	●	●
6.3A	250V	350V	●	●	●	●
8A	250V	350V	●	●		●

耐久测试 Endurance test

通过额定电流值100%(亦即 1.0 x In A)1.5小时后, 保险丝的表面温度不应超过75度。
Loaded with the 100% nominal current (or 1.0 x, A) for 1.5 hours, fuse surface temperature should not exceed 75 celsius degrees.



Chip™ Fuses

0603FA Series, Fast-Acting



Description

- Fast-acting 0603 surface mount fuse
- Excellent temperature and cycling characteristics
- Compatible with lead free solders and higher temperature profiles

Electrical Characteristics	
% of Amp Rating	Opening Time
100%	4 Hours Minimum
200%	60 Seconds Maximum

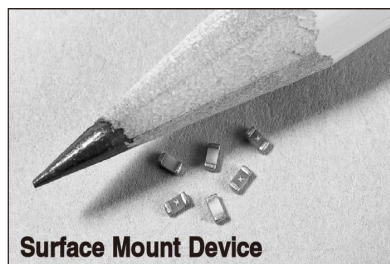

Surface Mount Device

Agency Information

- UL Recognition Guide & File numbers: JDYX2 & E19180
- CSA Component Acceptance: 053787 C 000 & Class Number: 1422 30

Environmental Data

- Operating temperature: -55°C to 125°C with proper derating
- Load humidity test: MIL-STD-202, Method 103B
- Moisture resistance test: MIL-STD-202, Method 106E
- Thermal shock test: MIL-STD-202, Method 107D
- High frequency vibration test: MIL-STD-202, Method 204D

Ordering

- Specify packaging and product code (i.e., TR/0603FA250-R)

Dimensions – mm/inches

Drawing Not to Scale

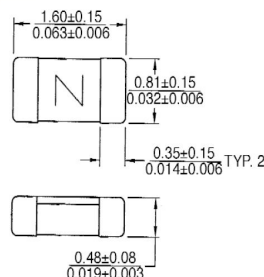

Recommended Pad Layout – mm/inches

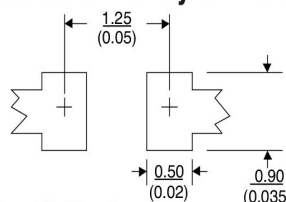

Soldering Method

- Wave solder: 260°C, 10 sec max.
- Solder reflow: 260°C, 30 sec max.

Specifications

Part Number	Current Rating (amps)	Voltage Rating	Interrupting Rating (amps) at Rated Voltage*	DC Cold Resistance** (Ω) Typical	Typical Melting I ^{†††}	Typical Voltage Drop†	Alpha Code Marking‡
0603FA250-R	250mA	50Vdc	50	3.100	0.0004	0.921	D
0603FA375-R	375mA	50Vdc	50	1.250	0.0009	0.605	E
0603FA500-R	500mA	32Vac/50dc	50ac/35dc	1.025	0.00193	0.600	F
0603FA750-R	750mA	32Vac/dc	50	0.450	0.0090	0.440	G
0603FA1-R	1	32Vac/dc	50	0.150	0.0025	0.211	H
0603FA1.25-R	1.25	32Vac/dc	35	0.108	0.0130	0.151	J
0603FA1.5-R	1.5	32Vac/dc	35	0.086	0.0319	0.138	K
0603FA2-R	2	32Vac/dc	35	0.051	0.0491	0.116	N
0603FA2.5-R	2.5	32Vac/dc	35	0.037	0.0625	0.113	O
0603FA3-R	3	32Vac/dc	35	0.028	0.0699	0.110	P
0603FA3.5-R	3.5	32Vac/dc	35	0.022	0.1200	0.103	R
0603FA4-R	4	32Vac/dc	35	0.017	0.2430	0.097	S
0603FA5-R	5	32Vac/dc	35	0.011	0.6950	0.090	T

* DC Interrupting rating (Measured at designated voltage, time constant of less than 50 microseconds, battery source)

** DC Cold resistance (Measured at ≤10% of rated current)

*** Typical melting I^{†††} (Measured with a battery bank at rated DC voltage, 10x-rated current, not to exceed IR, time constant of calibrated circuit less than 50 microseconds) (0603FA4A and 5A measured at interrupting rating)

† Typical voltage drop (Measured at rated current after temperature stabilizes)

‡ Alpha code to be marked on the top of fuse body for all ratings



Chip Fuses
CC06H Series High I²t 0603 Size Fuse

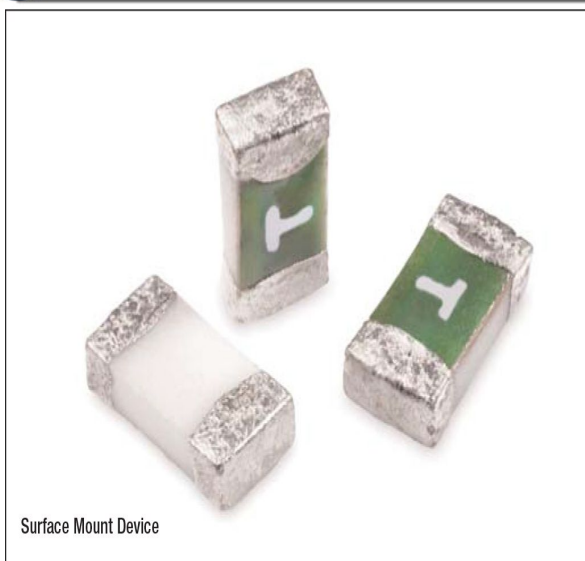

Features

- Halogen free
- High inrush withstand capability
- Fast-acting performance
- RoHS compliant
- Lead free
- Ampacity alpha mark on fuse for easy identification
- Standard termination design for easy solderability
- Compatible with standard lead-free solder reflow and wave soldering processes
- Excellent environmental integrity

Applications

For secondary protection in space constrained applications such as:

- LCD backlight inverters
- Digital cameras
- DVD players
- Bluetooth headsets
- Battery packs

Agency Information

- Recognized Card: (1A-5A) Guide JDXY2, File E19180

Part Numbering System: CC06H 1A -TR



Packaging

- TR - Packaging code suffix for tape-and-reel (8mm wide tape on 178mm diameter reel - specification EIA 481-1)
- Quantity = 5000 fuses

Electrical Characteristics		
Amp Rating	% of Amp Rating	Opening Time
1-5A	100	4 Hours
1-5A	200	1-60 Seconds
1-5A	250	5 Seconds Maximum

Description

The Chip™ CC06H Series high I²t fuse is a very small surface mount fuse (0603 size) designed to protect low voltage circuits from the harmful effects of short-circuits. The technology of this series combines the robust Cooper Bussmann® solid matrix fuse construction with advanced fuse element design to deliver state-of-the-art overcurrent protection on circuits subject to inrush currents.

Specifications									
Catalog Number	Amp Rating ⁵	Alpha Marking	Voltage Rating Vdc	Interrupting Rating (amps) ^{1,4}	Typical Resistance (Ω) ²	Typical Melt I ² t ³	Typical Voltage Drop (V)	Typical Power Loss (W)	Agency Approvals
									cRUus
CC06H1A	1	B	32	50	0.225	0.02	0.295	0.30	x
CC06H1.5A	1.5	H	32	50	0.122	0.07	0.220	0.33	x
CC06H2A	2	K	32	50	0.061	0.20	0.160	0.32	x
CC06H2.5A	2.5	L	32	50	0.045	0.25	0.145	0.36	x
CC06H3A	3	O	32	50	0.027	0.30	0.110	0.33	x
CC06H3.5A	3.5	R	32	50	0.021	0.60	0.100	0.35	x
CC06H4A	4	S	32	50	0.018	1	0.100	0.40	x
CC06H5A	5	T	32	50	0.013	2	0.088	0.44	x

1. DC Interrupting Rating (measured at rated voltage, time constant of less than 50 microseconds, battery source).
2. DC Cold Resistance are measured at <10% of rated current in ambient temperature of 20°C - FOR REFERENCE ONLY - CONTROLLED VALUES HELD BY PLANT AND SUBJECT TO CHANGE WITHOUT NOTICE.
3. Typical Pre-arcing I²t are measured at 10I_n current.

4. The insulation resistance after breaking capacity test is higher than 0.1MΩ when measured by 2X rated voltage.
5. Device designed to carry rated current for 4 hours minimum. An operating current 80% or less of rated current is recommended, with further design derating required at elevated ambient temperature. See Temperature Derating Curve on next page.



Chip™ Fuses

3216FF Series, Fast-Acting (1206)

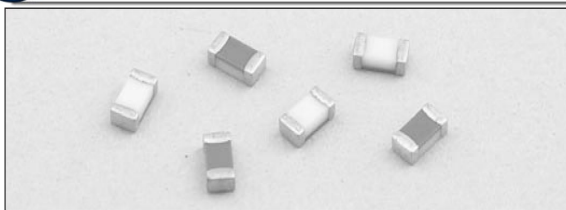

Description

- Fast-acting surface mount fuse
- Ratings up to 30 amps
- Excellent temperature and cycling characteristics
- Compatible with reflow and wave solder

Agency Information

- UL Recognition Guide JDYX2 & File E19180.
- CSA Component Acceptance: 053787 C 000 & Class No: 1422 30.
- cULus Recognition File: E19180, Guide JDYX2/JDYX8

Environmental Data

- Thermal Shock: MIL-STD-202, Method 107, Test Condition B (-65°C to 125°C)
- Vibration: MIL-STD-202, Method 204, Test Condition C (55Hz - 2kHz, 10G)
- Moisture Resistance: MIL-STD-202, Method 106, 10 day cycle
- Solderability: ANSI/J-STD-002, Test B
- Additional resistance to solder heat test: MIL-STD-202G Method 210F Condition A
- Operating Temperature: -55°C to 125°C

Ordering

- Specify packaging and product code (i.e., TR/3216FF250-R)

Soldering Method

- Wave Immersion: 260°C, 10 sec max.
- Infrared Reflow: 260°C, 30 sec max.

Electrical Characteristics

Amp Rating	% of Amp Rating	Opening Time
250mA - 30A	100%	4 Hrs. Min.
1.25A - 3A	200%	60 Sec. Max.
250mA - 3A	250%	5 Sec. Max.
4A - 7A	350%	1 Sec. Max.
10A - 30A	350%	5 Sec. Max.

Dimension - mm/inches

Drawing Not to Scale

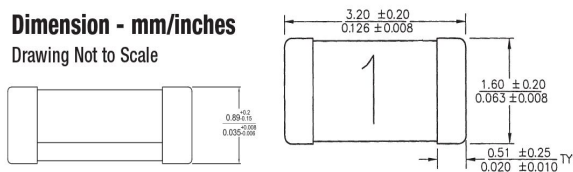

Recommended Pad Layout - mm (in)

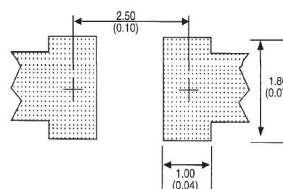

Specifications

Part Number	Volt Ratings		Interrupting Rating* (amps) AC/DC	Typical DC Cold Resistance (Ω)**	Typical Melt I ² t (A ² S) DC***	Typical Voltage Drop (V)†	Agency Approvals		
	Vac	Vdc					UR	CSA	cURus
3216FF250-R	32	63	50	3.5000	0.00038	1.40	X	X	
3216FF375-R	32	63	50	1.7500	0.00077	0.73	X	X	
3216FF500-R	32	63	50	0.9800	0.00190	0.66	X	X	
3216FF750-R	32	63	50	0.5400	0.0053	0.63	X	X	
3216FF1-R	32	63	50	0.2190	0.030	0.20	X	X	
3216FF1.25-R	32	63	50	0.1700	0.046	0.18	X	X	
3216FF1.5-R	32	63	50	0.1190	0.093	0.18	X	X	
3216FF2-R	32	63	50	0.0660	0.126	0.16	X	X	
3216FF2.5-R	32	63	50	0.0460	0.260	0.14	X	X	
3216FF3-R	32	63	50	0.0360	0.275	0.13	X	X	
3216FF4-R	32	32	50	0.0180	0.337	0.11	X	X	
3216FF4.5-R	32	32	50	0.0160	0.405	0.10	X	X	
3216FF5-R	32	32	50	0.0140	0.534	0.09	X	X	
3216FF6.5-R	32	32	50	0.0086	2.294	0.076	X	X	
3216FF7-R	32	32	50	0.0070	3.623	0.078	X	X	
3216FF10-R		24	150	0.0045	2.0	0.062	X		X
3216FF12-R		24	150	0.0039	7.0	0.070	X		X
3216FF15-R		24	150	0.0031	25.5	0.066	X		X
3216FF20-R		24	150	0.0018	48.6	0.060	X		X
3216FF25-R		24	250	0.0014	32.0	0.057	X		X
3216FF30-R		24	300	0.001	43.0	0.068	X		X

* AC Interrupting Rating measured at rated voltage with a unity power factor; DC Interrupting Rating measured at rated voltage, time constant of less than 50 microseconds, battery source

**Typical DC Cold Resistance measured at 10% of rated current

***Typical Melting I²t measured with a battery bank at rated DC voltage, 10x-rated current, not to exceed IR, time constant of calibrated circuit less than 50 microseconds (6.5A - 30A measured at interrupting rating)

†Typical Voltage Drop measured at rated current after temperature stabilizes. It is recommended that fuses be mounted with ceramic (white) side facing up.

Device designed to carry rated current for four hours minimum. An operating current of 80% or less of rated current is recommended, with further derating required at elevated ambient temperatures.





High I²t Chip™ Fuses

CC12H Series (1206)

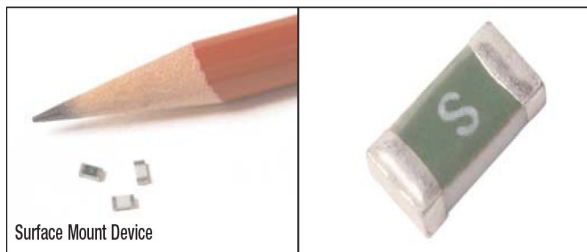

Description

- High I²t 1206 footprint surface mount fuse
- High inrush withstand capability
- Excellent temperature and cycling characteristics
- RoHS compliant, and lead free and halogen free construction
- Compatible with solder reflow and wave solder

Electrical Characteristics		
Amp Rating	% of Amp Rating	Opening Time
1-5A	100%	4 Hours Minimum
1-3A	200%	1-60 Seconds
1-5A	250%	5 Seconds Maximum
1-5A	300%	0.1-3 Seconds
1-5A	1000%	0.2-20mS

Agency Information

- Recognition File number: E19180 (1- 5A)

Environmental Data

- Thermal Shock: MIL-STD-202, Method 107, Test Condition B
- Vibration: MIL-STD-202, Method 204, Test Condition C
- Moisture Resistance: MIL-STD-202, Method 106, 50 day cycle
- Solderability: ANSI/J-STD-002, Test B
- Normal ambient temperature: 23°C
- Operating temperature range -40°C to 125°C

Dimensions - mm (in)

Drawing Not to Scale

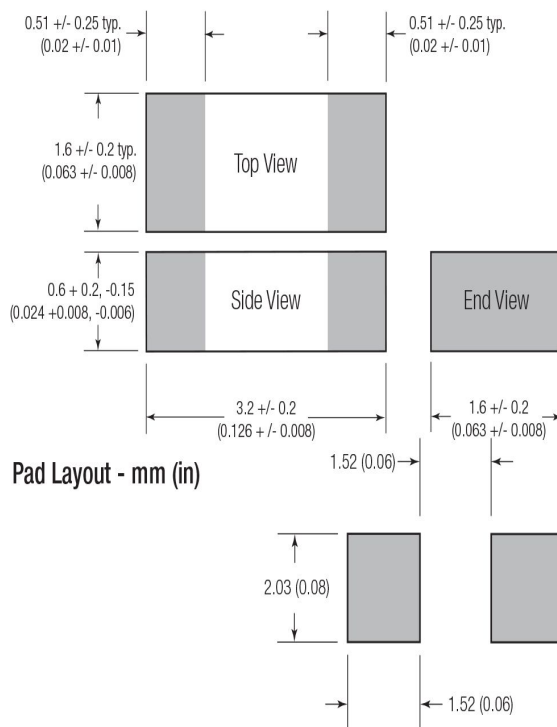

Soldering Method

- Wave Solder Immersion: 260°C, 10 seconds maximum.
- Solder Reflow: 260°C, 30 seconds maximum.

Packaging and Ordering

- 3000 fuses on 8mm tape-and-reel on a 7 inch (178mm) reel per EIA Standard 481. Specify Catalog Symbol and package code suffix "-TR" (e.g., CC12H1A-TR)

Specifications							
Catalog Symbol	Current Rating (Amps)	Amp Rating Mark	Voltage Rating (Vdc)	Interrupting Rating* (Amps)	Resistance (Ω)** Typical	Typical Melt (I ² t)† DC	Typical Voltage Drop (mV)‡
CC12H1A	1	H	63	50	0.35	0.18	490
CC12H1.5A	1.5	K	63	50	0.178	0.4	355
CC12H2A	2	N	63	50	0.10	1.1	305
CC12H2.5A	2.5	O	63	50	0.07	1.7	240
CC12H3A	3	P	63	50	0.045	2.2	185
CC12H3.5A	3.5	R	63	50	0.034	2.7	180
CC12H4A	4	S	63	50	0.03	3.2	169
CC12H4.5A	4.5	X	32	100	0.025	4.2	160
CC12H5A	5	T	32	100	0.021	6.0	140

* DC Interrupting Rating (Measured at rated voltage, time constant of less than 50 microseconds, battery source)

** DC Cold Resistance (Measured at 10% of rated current)

† Typical Melting I²t (Measured with a battery bank at rated DC voltage, 10x-rated current, not to exceed IR, time constant of calibrated circuit less than 50 microseconds)

‡ Typical Voltage Drop (Measured at rated current after temperature stabilizes)

Device designed to carry rated current for four hours minimum. An operating current of 80% or less of rated current is recommended, with further derating required at elevated ambient temperatures.



Fast-Acting Subminiature Fuses

6125FF Series



Description

- Fast-acting surface mount fuse
- Overcurrent protection of systems up to 125Vac/72Vdc
- High inrush withstand capability
- Solder immersion compatible

Electrical Characteristics	
% of Amp Rating	Opening Time
100%	4 Hours Minimum
200%	5 Second Maximum

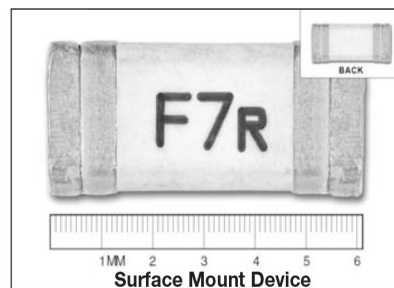

Agency Information

- cULus Recognition File: E19180

Environmental Data

- Operating temperature: -55°C to 125°C
- Mechanical shock: MIL-STD-202, Method 213
- High frequency vibration: MIL-STD-202, Method 204
- Load humidity: MIL-STD-202, Method 103
- Moisture resistance: MIL-STD-202, Method 106
- Resistance to solvents: MIL-STD-202, Method 215
- Thermal shock: MIL-STD-202, Method 107

Ordering

- Specify packaging and product code (i.e., TR2/6125FF500-R)

Soldering Method

- Wave immersion: 260°C, 10 Sec. max.
- Solder reflow: 260°C, 30 Sec. max.

Dimensions - mm (in)

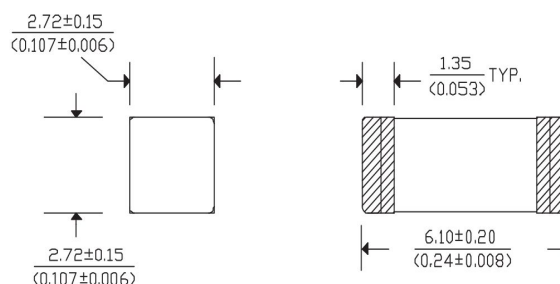

Recommended Pad Layout - mm (in)

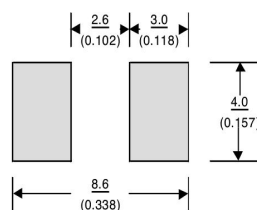

Specifications

Part Number	Current Rating (amps)	Voltage Rating		Interrupting Rating (amps)			DC Cold Resistance (mΩ) Typ.	Melting I ² t (A ² sec)	Typical Voltage Drop (mV)
		Vac	Vdc	125Vac	72Vdc	32Vdc			
6125FF500-R	500mA	125	72	50	50	300	750	0.08	605
6125FF750-R	750mA	125	72	50	50	300	350	0.152	433
6125FF1-R	1	125	72	50	50	300	260	0.22	415
6125FF1.25-R	1.25	125	72	50	50	300	171	0.355	410
6125FF1.5-R	1.5	125	72	50	50	300	112	0.456	365
6125FF2-R	2	125	72	50	50	300	49	1.67	160
6125FF2.5-R	2.5	125	72	50	50	300	45	5.20	155
6125FF3-R	3	125	72	50	50	300	35	6.24	153
6125FF3.5-R	3.5	125	72	50	50	300	27	7.28	150
6125FF4-R	4	125	72	50	50	300	26	7.4	145
6125FF5-R	5	125	72	50	50	300	17	9.5	141
6125FF6.3-R	6.3	125	72	50	50	300	14	15.1	135
6125FF7-R	7	125	72	50	50	300	11	37.25	112
6125FF8-R	8	125	72	50	50	300	8.7	70	110
6125FF10-R	10	125	72	50	50	300	7.3	67.75	110
6125FF12-R	12	125	72	50	50	300	5.3	210.59	106
6125FF15-R	15	125	72	50	50	300	4.2	296.10	104

* AC Interrupting Rating (Measured at designated voltage, 100% power factor); DC Interrupting Rating (Measured at designated voltage, time constant of less than 50 microseconds, battery source)

** Typical Melting I²t (Measured at 72Vdc, 10X rated current (not exceed 50A - IR @ 72Vdc))



Description

- Time Delay surface mount fuse
- Complies with EIA-IS-722 Standard
- Solder Immersion Compatible

ELECTRICAL CHARACTERISTICS	
% of Amp Rating	Opening Time
100%	4 Hours Minimum
200%	1 Second Minimum
200%	2-4 Seconds Typical
200%	60 Seconds Maximum

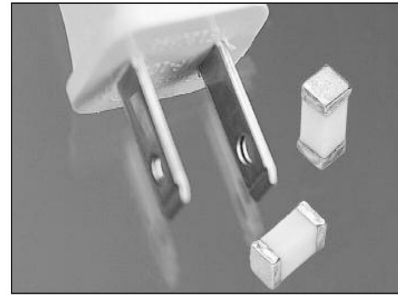

Agency Information

- UL Recognition Guide & File numbers: JDYX2 & E19180.
- CSA Component Acceptance: 053787 C 000 & Class No: 1422 30.

Environmental Data

- Life Test: MIL-STD-202, Method 108A, Test Condition D
- Load Humidity: MIL-STD-202, Method 103B
- Moisture Resistance: MIL-STD-202, Method 106E
- Thermal Shock: MIL-STD-202, Method 107D, air-to-air
- Case Resistance: EIA/IS-722
- Resistance to Dissolution of Metallization: ANSI J-STD-002, Test D
- Mechanical Shock: MIL-STD-202, Method 213B, Test Condition A
- High Frequency Vibration: MIL-STD-202, Method 204D, Test Condition D
- Resistance to Solvents: MIL-STD-202, Method 215A

Ordering

- Specify packaging and product code (i.e., TR1/6125TD500-R)

Dimensions mm/(inches)

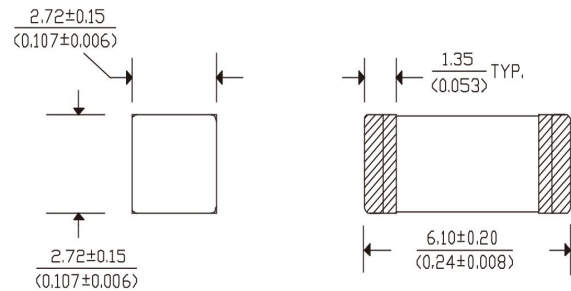

Land Pattern

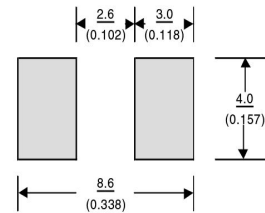

Soldering Method

- Wave Immersion: 260°C, 10 sec max.
- Infrared: 260°C, 30 sec max.

SPECIFICATIONS

Product Code	Current Rating	Voltage Rating		Interrupting Rating*		Resistance (ohms)** Typ.	Typical Melting I ^{††}	Typical Voltage Drop‡
		AC	DC	125VAC	60VDC			
6125TD500-R	500mA	125V	60V	50A	50A	0.4025	0.716	245 mV
6125TD750-R	750mA	125V	60V	50A	50A	0.2350	1.07	250 mV
6125TD1-R	1A	125V	60V	50A	50A	0.1680	2.88	256 mV
6125TD1.5-R	1.5A	125V	60V	50A	50A	0.0630	2.35	125 mV
6125TD2-R	2A	125V	60V	50A	50A	0.0480	9.45	133 mV
6125TD2.5-R	2.5A	125V	60V	50A	50A	0.0350	16.2	130 mV
6125TD3-R	3A	125V	60V	50A	50A	0.0263	15.3	97 mV
6125TD3.5-R	3.5A	125V	60V	50A	50A	0.0195	14.5	95 mV
6125TD4-R	4A	125V	60V	50A	50A	0.0185	38.8	106 mV
6125TD5-R	5A	125V	60V	50A	50A	0.0133	34.4	100 mV
6125TD7-R	7A	125V	60V	50A	50A	0.0087	90.2	99 mV

* AC Interrupting Rating (Measured at designated voltage, 100% power factor); DC Interrupting Rating (Measured at designated voltage, time constant of less than 50 microseconds, battery source)

** DC Cold Resistance (Measured at 10% of rated current)

† Typical Melting I^{††} (Measured with a battery bank at rated DC voltage, 10x-rated current (not to exceed IR), time constant of calibrated circuit less than 50 microseconds)

‡ Typical Voltage Drop (Measured at rated current after temperature stabilizes)

Device designed to carry rated current for four hours minimum. An operating current of 80% or less of rated current is recommended, with further derating required at elevated ambient temperatures.



Brick™ Fuses

1025FA Series, Fast-Acting



Description

- Fast-acting surface-mount fuse
- Satisfies the EIA/IS-722 Standard
- Solder immersion compatible

Electrical Characteristics	
% of Amp Rating	Opening Time
100%	4 Hours Minimum
200% (250mA-5A)	5 Seconds Maximum
250% (250mA-5A fuse)	1 Second Maximum
200% (7-15A fuse)	20 Seconds Maximum
250% (7-15A fuse)	4 Seconds Maximum

Note: 30vdc constant current source required for 200% overload tests on 250mA-1A.

Agency Information

- UL Recognition Guide & File numbers: JDYX2 & E19180 (250mA - 15A)
- CSA Component Acceptance: File # 053787 C000, Class # 1422 30

Environmental Data

- Life test: MIL-STD-202, Method 108A, Test Condition D
- Load humidity: MIL-STD-202, Method 103B
- Moisture resistance: MIL-STD-202, Method 106E
- Terminal strength: MIL-STD-202, Method 211A
- Thermal shock: MIL-STD-202, Method 107D, air-to-air
- Case resistance: EIA/IS-722
- Resistance to dissolution of metallization: ANSI J-STD-002, Test D
- Mechanical shock: MIL-STD-202, Method 213B with exceptions per EIA/IS-722 Standard
- High frequency vibration: MIL-STD-202, Method 204D, Test Condition D
- Resistance to solvents: MIL-STD-202, Method 215A

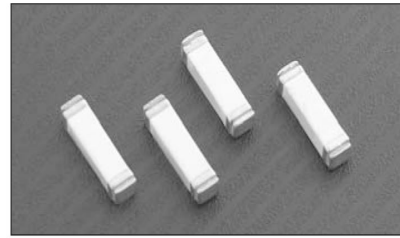

Dimensions – mm/in

Drawing Not to Scale

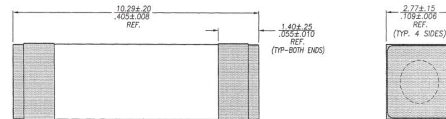

Recommended Pad Layout – mm (in)

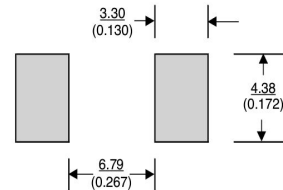

Ordering

- Specify packaging and product code (i.e., TR2/1025FA250-R)

Soldering Method

- Wave solder: 260°C, 10 Sec max.
- Infrared reflow: 260°C, 30 Sec max.

Specifications									
Product Code	Current Rating (amps)	Voltage Rating		Interrupting Rating (amps)*			DC Cold Resistance** (Ω) Typical	Typical Melting †‡	Typical Voltage Drop‡
		AC	DC	250Vac	125Vdc	60Vdc			
1025FA250-R	250mA	250V	125V	50	50	-	4.7500	0.1212	2019mV
1025FA500-R	500mA	250V	125V	50	50	-	1.1500	0.0415	1500mV
1025FA750-R	750mA	250V	125V	50	50	-	0.5550	0.143	880mV
1025FA1-R	1	250V	125V	50	50	-	0.2800	1.750	560mV
1025FA1.5-R	1.5	250V	125V	50	50	-	0.1140	1.460	260mV
1025FA2-R	2	250V	125V	50	50	-	0.0750	6.086	258mV
1025FA2.5-R	2.5	250V	125V	50	50	-	0.0510	8.48	232mV
1025FA3-R	3	250V	125V	50	50	-	0.0384	18.15	205mV
1025FA3.5-R	3.5	250V	125V	50	50	-	0.0305	17.83	185mV
1025FA4-R	4	250V	125V	50	50	-	0.0275	23.32	190mV
1025FA5-R	5	250V	125V	50	50	-	0.0195	38.74	180mV
1025FA7-R	7	250V	60V	50	-	50	0.0116	138	150mV
1025FA10-R	10	250V	60V	50	-	50	0.0072	457	146mV
1025FA12-R	12	250V	60V	50	-	50	0.0056	498	120mV
1025FA15-R	15	250V	60V	50	-	50	0.0039	1451	110mV

* AC interrupting rating (measured at designated voltage, 100% power factor random closing); DC interrupting rating (measured at designated voltage, time constant of less than 50 microseconds, battery source)
 ** DC cold resistance (measured at ≤10% of rated current)
 † Typical Melting †‡ (measured with a battery bank at rated DC voltage, 10x-rated current, but not exceeding the interrupting rating. Time constant of calibrated circuit less than 50 microseconds). Test current not to exceed interrupting rating of 50A.
 ‡ Typical voltage drop (measured at rated current after temperature stabilizes)
 • Device designed to carry rated current for four hours minimum. An operating current of 80% or less of rated current is recommended, with further derating required at elevated ambient temperatures.



Description

- Time-delay surface mount fuse
- Satisfies the EIA/IS-722 Standard
- Solder immersion compatible

Electrical Characteristics	
% of Amp Rating	Opening Time
100%	4 Hours Minimum
200%	1 Second Minimum
200%	60 Seconds Maximum
250% *	10 Seconds Maximum

* If fuse does not open @ 200% in 60 seconds, raise current to 250% and the fuse must open in 10 seconds maximum.

Agency Information

- UL Recognition Guide & File numbers: JDYX2 & E19180 (250mA - 5A)
- CSA Component Acceptance: File # 053787 C000, Class # 1422 30

Environmental Data

- Life test: MIL-STD-202, Method 108A, Test Condition D
- Load humidity: MIL-STD-202, Method 103B
- Moisture resistance: MIL-STD-202, Method 106E
- Terminal strength: MIL-STD-202, Method 211A
- Thermal shock: MIL-STD-202, Method 107D, air-to-air
- Case resistance: EIA/IS-722
- Resistance to dissolution of metallization: ANSI J-STD-002, Test D
- Mechanical shock: MIL-STD-202, Method 213B with exceptions per EIA/IS-722 Standard
- High frequency vibration: MIL-STD-202, Method 204D, Test Condition D
- Resistance to solvents: MIL-STD-202, Method 215A



Dimensions – mm (in)

Drawing Not to Scale

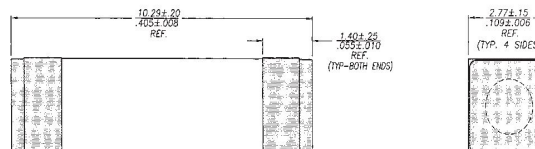

Recommended Pad Layout – mm (in)

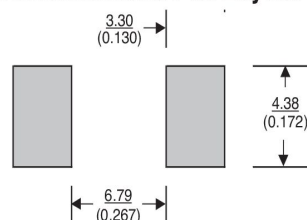

Ordering

- Specify packaging and product code (i.e., TR2/1025TD250-R)

Soldering Method

- Wave immersion: 260°C, 10 sec max.
- Infrared: 260°C, 30 sec max.

Product Code	Current Rating Amps	Voltage Rating		Interrupting Rating*		DC Cold Resistance** (Ω) Typical	Typical Melting Pt†	Typical Voltage Drop‡
		AC	DC	250Vac	125Vdc			
1025TD250-R	250mA	250	125	50A	50A	4.200	0.128	1900 mV
1025TD500-R	500mA	250	125	50A	50A	0.5500	1.47	455 mV
1025TD750-R	750mA	250	125	50A	50A	0.317	0.93	400 mV
1025TD1-R	1	250	125	50A	50A	0.2030	9.91	387 mV
1025TD1.5-R	1.5	250	125	50A	50A	0.1025	11.79	310 mV
1025TD2-R	2	250	125	50A	50A	0.0680	17.27	250 mV
1025TD2.5-R	2.5	250	125	50A	50A	0.0420	16.51	201 mV
1025TD3-R	3	250	125	50A	50A	0.0330	42.74	184 mV
1025TD3.5-R	3.5	250	125	50A	50A	0.0270	43.33	180 mV
1025TD4-R	4	250	125	50A	50A	0.0220	66.96	152 mV
1025TD5-R	5	250	125	50A	50A	0.0160	88.38	145 mV

* AC Interrupting Rating (Measured at designated voltage, 100% power factor random closing); DC Interrupting Rating (Measured at designated voltage, time constant of the calibrated circuit is less than 50 microseconds, battery source)

** DC Cold Resistance (Measured at ≤10% of rated current)

† Typical Melting Pt (Measured with a battery bank at rated DC voltage, 10x-rated current, time constant of calibrated circuit less than 50 microseconds)

‡ Typical Voltage Drop (Measured at rated current after temperature stabilizes)

• Device designed to carry rated current for four hours minimum. An operating current of 80% or less of rated current is recommended, with further derating required at elevated ambient temperatures.



插件式

可恢复保险丝
PPTC FUSE

RoHS

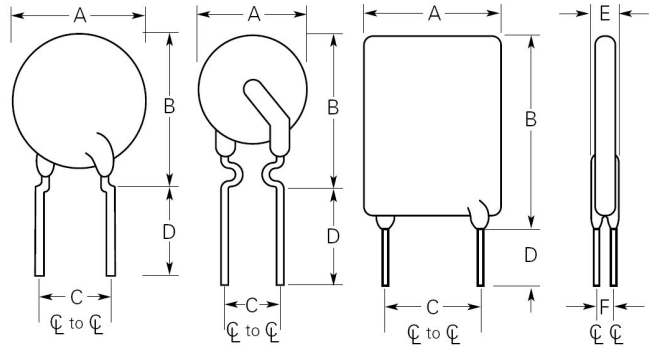
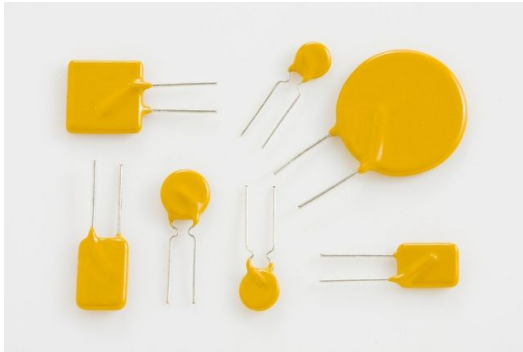

6V 系列 6V Product Data c

Model 型号	Ih	It	Vmax i	Imax	Rmin	Rmax	Product Dimensions (mm) 最大产品尺寸					
	A	A	V	A	Ω	Ω	Style	A	B	C	D	Lead
6-040	0.40	0.80	6	40	0.30	0.60	F4	6.0	8.5	5.1	3.0	0.5
6-050	0.50	1.00	6	40	0.20	0.50	F4	6.0	8.5	5.1	3.0	0.5
6-065	0.65	1.30	6	40	0.16	0.32	F4	6.0	8.5	5.1	3.0	0.5
6-075	0.75	1.50	6	40	0.14	0.23	F4	6.0	8.5	5.1	3.0	0.5
6-090	0.90	1.80	6	40	0.10	0.18	F3	6.5	9.5	5.1	3.0	0.5
6-110	1.10	2.20	6	40	0.08	0.14	F3	6.0	12.8	5.1	3.0	0.5
6-120	1.20	2.40	6	40	0.08	0.14	F2	6.9	13.9	5.1	3.0	0.5
6-135	1.35	2.70	6	40	0.06	0.115	F3	8.8	15.8	5.1	3.0	0.5
6-160	1.60	3.20	6	40	0.05	0.110	F1	9.5	16.5	5.1	3.0	0.5
6-185	1.85	3.70	6	40	0.05	0.085	F1	9.8	18.6	5.1	3.0	0.5
6-250	2.50	5.00	6	40	0.03	0.06	F1	11.5	20.5	5.1	3.0	0.5

16V 系列 6v Product Data

Model 型号	Ih	It	Vmax i	Imax	Rmin	Rmax	Product Dimensions (mm) 最大产品尺寸					
	A	A	V	A	m Ω	m Ω	Style	A	B	C	D	Lead
16-100	1.0	1.7	16	40	100	300	F2	7.0	10.5	5.1	3.0	0.6
16-200	2.0	3.4	16	40	50	120	F1	6.0	12.8	5.1	3.0	0.6
16-300	3.0	5.1	16	100	34	72	F1	8.8	11.8	5.1	3.0	0.8
16-400	4.0	6.8	16	100	18	43	F1	9.5	12.5	5.1	3.0	0.8
16-500	5.0	8.5	16	100	14	30	F1	9.8	14.6	5.1	3.0	0.8
16-600	6.0	10.2	16	100		25	F1	11.6	14.6	5.1	3.0	0.8
16-700	7.0	11.9	16	100	8	19	F1	13.0	17.0	5.1	3.0	0.8
16-800	8.0	13.6	16	100		14.5	F1	14.5	20.0	5.1	3.0	0.8
16-900	9.0	15.3	16	100		12	F1	14.5	20.0	5.1	3.0	0.8
16-1000	10.0	17.0	16	100	4.5	11	F1	17.5	24.5	10.2	3.0	0.8
16-1100	11.0	18.7	16	100	4	10	F1	17.5	24.5	10.2	3.0	0.8
16-1200	12.0	20.4	16	100	3.5	9	F1	17.5	24.5	10.2	3.0	0.8
16-1400	14.0	23.8	16	100		8	F1	20.5	28.0	10.2	3.0	0.8

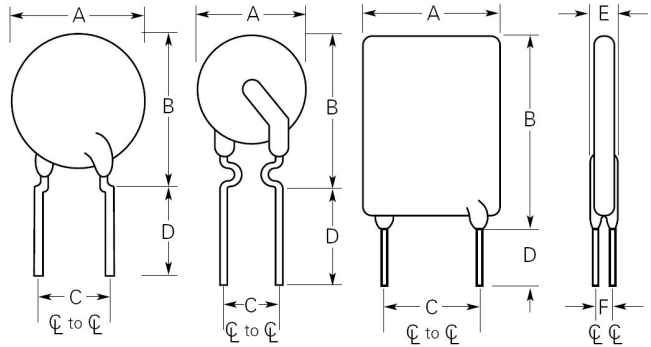

30V 系列 30V Series Data

Model 型号	Ih	It	Vmax	Imax	Rmin	Rmax	Product Dimensions (mm) 最大产品尺寸					
	A	A	V	A	mΩ	mΩ	Style	A	B	C	D	Lead
30-050	0.50	1.0	30	40	200	500	F3	6.0	8.5	5.1	3.0	0.5
30-070	0.70	1.4	30	40	120	290	F3	7.0	10.0	5.1	3.0	0.5
30-090	0.90	1.8	30	40	90	220	F2	6.5	9.5	5.1	3.0	0.5
30-110	1.10	2.2	30	40	70	170	F2	6.0	12.8	5.1	3.0	0.5
30-135	1.35	2.7	30	40	55	130	F1	8.8	15.8	5.1	3.0	0.5
30-160	1.60	3.2	30	40	45	110	F1	9.5	16.5	5.1	3.0	0.5
30-185	1.85	3.7	30	40	35	90	F1	9.8	18.6	5.1	3.0	0.5
30-250	2.5	5.0	30	40	27	65	F1	11.5	20.5	5.1	3.0	0.6
30-300	3.0	6.0	30	40	22	55	F2	11.5	16.5	5.1	3.0	0.8
30-400	4.0	8.0	30	40	18	45	F2	14.0	19.6	5.1	3.0	0.8
30-500	5.0	10.0	30	40	13.5	33	F2	14.0	19.6	10.2	3.0	0.8
30-600	6.0	12.0	30	40		25	F2	17.5	24.5	10.2	3.0	0.8
30-700	7.0	14.0	30	40		20	F2	17.5	24.5	10.2	3.0	0.8
30-800	8.0	16.0	30	40	7	17	F2	20.5	28.0	10.2	3.0	0.8
30-900	9.0	18.0	30	40	6	14.5	F2	24.5	28.5	10.2	3.0	0.8

60V 系列 60V Series Data

Model 型号	Ih	It	Vmax	Imax	Rmin	Rmax	Product Dimensions (mm) 最大产品尺寸					
	A	A	V	A	Ω	Ω	Style	A	B	C	D	Lead
60-005	0.05	0.10	60	40	10	25.0	F2	6.0	8.5	5.1	3.1	0.5
60-010	0.10	0.20	60	40	3.00	7.5	F2	6.0	8.5	5.1	3.1	0.5
60-017	0.17	0.34	60	40	1.80	5.80	F2	6.0	8.5	5.1	3.1	0.5
60-020	0.20	0.40	60	40	1.50	3.300	F2	6.0	8.5	5.1	3.1	0.5
60-025	0.25	0.50	60	40	1.00	2.20	F2	6.0	8.5	5.1	3.1	0.5
60-030	0.30	0.60	60	40	0.70	1.55	F2	6.7	10.7	5.1	3.1	0.5
60-040	0.40	0.80	60	40	0.50	1.10	F1	7.2	14.2	5.1	3.1	0.5
60-050	0.50	1.00	60	40	0.35	0.85	F1	7.5	14.5	5.1	3.1	0.5
60-065	0.65	1.30	60	40	0.30	0.66	F1	9.1	16.1	5.1	3.1	0.5
60-075	0.75	1.50	60	40	0.25	0.55	F1	9.8	16.8	5.1	3.1	0.5
60-090	0.90	1.80	60	40	0.20	0.45	F1	11.0	18.0	5.1	3.1	0.5
60-110	1.10	2.20	60	40	0.15	0.33	F2	12.5	17.5	5.1	3.1	0.8
60-135	1.35	2.70	60	40	0.12	0.27	F2	14.2	19.2	5.1	3.1	0.8
60-160	1.60	3.20	60	40	0.09	0.22	F2	16.3	21.3	5.1	3.1	0.8
60-185	1.85	3.70	60	40	0.08	0.18	F2	17.4	22.4	5.1	3.1	0.8
60-250	2.50	5.00	60	40	0.055	0.11	F2	21.6	26.6	10.2	3.1	0.8
60-300	3.00	6.00	60	40	0.045	0.09	F2	24.8	29.8	10.2	3.1	0.8
60-375	3.75	7.50	60	40	0.035	0.08	F2	27.0	32.0	10.2	3.1	0.8
60-500	5.00	10.0	60	40	0.03	0.07	F2	28.5	33.5	10.2	3.1	0.8

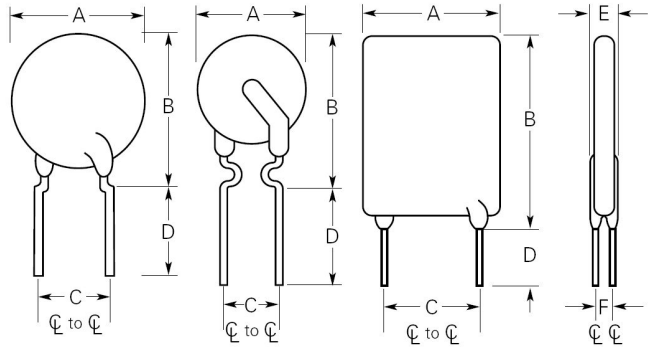

130V 系列 130V Series Data

Model 型号	Ih	It	Vmax	Imax	Rmin	Rmax	Product Dimensions (mm) 最大产品尺寸					
	A	A	V	A	Ω	Ω	Style	A	B	C	D	Lead
130-050	0.05	0.10	130	20	20	60	F2	8.3	10.7	5.1	3.8	0.5
130-080	0.08	0.16	130	20	12	24	F2	8.3	10.7	5.1	3.8	0.5
130-100	0.10	0.20	130	20	9.0	18	F2	8.3	10.7	5.1	3.8	0.5
130-120	0.12	0.24	130	20	6.0	12	F2	8.3	10.7	5.1	3.8	0.5
130-160	0.16	0.32	130	20	3.5	7.5	F2	9.9	12.5	5.1	3.8	0.5
130-200	0.20	0.40	130	20	2.5	5.0	F1	9.6	17.4	5.1	3.8	0.6
130-250	0.25	0.50	130	20	1.9	3.8	F1	9.6	17.4	5.1	3.8	0.6
130-300	0.30	0.60	130	20	1.3	2.6	F1	11.4	16.5	5.1	3.8	0.6
130-400	0.40	0.80	130	20	0.9	1.8	F1	11.5	19.5	5.1	3.8	0.6
130-500	0.50	1.00	130	20	0.8	1.6	F1	14.0	21.7	5.1	3.8	0.8
130-650	0.65	1.30	130	10	0.5	1.0	F1	14.0	21.7	5.1	3.8	0.8
130-750	0.75	1.50	130	10	0.4	0.8	F3	14.0	21.7	5.1	3.8	0.8
130-900	0.90	1.80	130	10	0.3	0.6	F3	14.0	21.7	5.1	3.8	0.8
130-1100	1.10	2.20	130	10	0.3	0.5	F2	13.2	16.2	5.1	3.8	0.8
130-1350	1.35	2.70	130	10	0.2	0.4	F1	18.0	25.0	5.1	3.8	0.8
130-1600	1.60	3.20	130	10	0.15	0.30	F1	18.0	25.0	10.2	3.8	0.8
130-1850	1.85	3.70	130	10	0.12	0.25	F1	18.0	25.0	10.2	3.8	0.8
130-2000	2.00	4.00	130	10	0.11	0.22	F1	18.0	25.0	10.2	3.8	0.8
130-2500	2.50	5.00	130	10	0.08	0.16	F1	24.8	30.2	10.2	3.8	0.8
130-3000	3.00	6.00	130	10	0.06	0.12	F1	26.2	32.8	10.2	3.8	0.8

250V 系列 250V Series Data

Model 型号	Ih	It	Vmax	Imax	Rmin	Rmax	Product Dimensions (mm) 最大产品尺寸					
	A	A	V	A	Ω	Ω	Style	A	B	C	D	Lead
250-030	0.03	0.06	250	1	35	90	F2	6.0	8.0	5.1	4.6	0.5
250-040	0.04	0.08	250	1	27	65	F2	6.0	8.0	5.1	4.6	0.5
250-050	0.05	0.10	250	1	20	45	F2	6.0	8.0	5.1	4.6	0.5
250-060	0.06	0.12	250	3	20	45	F2	6.5	9.0	5.1	4.6	0.6
250-080	0.08	0.16	250	3	10	22	F2	6.5	9.0	5.1	4.6	0.5
250-090	0.09	0.18	250	3	7.0	17.5	F2	6.5	9.0	5.1	4.6	0.5
250-110	0.11	0.22	250	3	6.0	12	F1	7.0	9.5	5.1	4.6	0.6
250-120	0.12	0.24	250	3	6.5	10.5	F1	7.0	9.5	5.1	4.6	0.6
250-145	0.145	0.29	250	3	3.5	6.5	F1	7.0	9.5	5.1	4.6	0.6
250-180	0.18	0.36	250	10	1.35	3.0	F2	10.5	13.5	5.1	4.6	0.6
250-200	0.20	0.40	250	10	3.0	6.0	F2	10.5	13.5	5.1	4.6	0.6
250-400	0.40	0.80	250	10	1.35	3.0	F1	11.2	14.2	5.1	4.6	0.8
250-600	0.60	1.20	250	10	1.0	2.0	F1	12.6	15.6	5.1	4.6	0.8
250-800	0.80	1.60	250	10	0.5	1.0	F1	15.0	19.5	5.1	4.6	0.8
50-1000	1.00	2.00	250	10	0.4	0.8	F2	21.1	23.6	10.2	4.6	0.8
250-1500	1.50	3.00	250	10	0.3	0.6	F1	21.0	27.5	10.2	4.6	0.8
250-2000	2.00	4.00	250	10	0.2	0.4	F1	26.2	32.8	10.2	4.6	0.8



贴片式

贴片保险丝 SMD PTC FUSE



1206

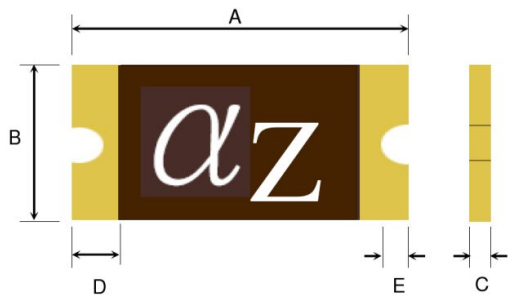

Terminal Pad Solderability:
Meets EIA Specification RS186-9E And ANSI/J-STD-002 Category 3.
Terminal Pad Materials:
Gold-Plated Nickel-Copper or Tin-plated Nickel-Copper Lead-Free, RoHS Compliant

PHYSICAL DIMENSIONS (mm)

Model	Marking	A		B		C		D		E	
		Min.	Max.	Min.	Max.	Min.	Max.	Min.	Max.	Min.	Max.
nSMD005	αZ	3.00	3.50	1.50	1.80	0.60	1.10	0.15	0.10		
nSMD010	αN	3.00	3.50	1.50	1.80	0.60	1.10	0.15	0.10		
nSMD020	αA	3.00	3.50	1.50	1.80	0.40	0.90	0.15	0.10		
nSMD025	αA	3.00	3.50	1.50	1.80	0.40	0.90	0.15	0.10		
nSMD035	αB	3.00	3.50	1.50	1.80	0.40	0.90	0.15	0.10		
nSMD050	αF	3.00	3.50	1.50	1.80	0.35	0.85	0.15	0.10		
nSMD075	αG	3.00	3.50	1.50	1.80	0.30	0.80	0.15	0.10		
nSMD100	αH	3.00	3.50	1.50	1.80	0.40	0.80	0.15	0.10		
nSMD150	αI	3.00	3.50	1.50	1.80	0.50	1.20	0.15	0.10		
nSMD200	αK	3.00	3.50	1.50	1.80	0.50	1.20	0.15	0.10		

ELECTRICAL CHARACTERISTICS

Model	Marking	Vmax (Vdc)	Imax (A)	Ihold @25°C (A)	Itrip @25°C (A)	Pd Typ. (W)	Maximum Time To Trip		Resistance		
							Current	Time (Sec)	Rimin (Ω)	Rityp (Ω)	R1max (Ω)
nSMD005	αZ	60	100	0.05	0.15	0.4	0.25	1.5	3.600	10.000	50.000
nSMD010	αN	60.0	100	0.10	0.25	0.4	0.5	1.00	1.600	6.000	15.000
nSMD020	αA	30.0	100	0.20	0.40	0.6	8.0	0.08	0.350	0.480	2.500
nSMD025	αA	16.0	100	0.25	0.50	0.6	8.0	0.08	0.350	0.480	2.500
nSMD035	αB	6.0	100	0.35	0.75	0.6	8.0	0.10	0.250	0.380	1.300
nSMD050	αF	6.0	100	0.50	1.00	0.6	8.0	0.10	0.150	0.300	0.700
nSMD050-13.2V	αF	13.2	100	0.50	1.00	0.6	8.0	0.10	0.150	0.300	0.700
nSMD075	αG	6.0	100	0.75	1.50	0.6	8.0	0.20	0.090	0.160	0.500
nSMD100	αH	6.0	100	1.00	1.80	0.6	8.0	0.30	0.055	0.100	0.270
nSMD150	αI	6.0	100	1.50	3.00	0.8	8.0	1.00	0.040	0.070	0.130
nSMD200	αK	6.0	100	2.00	3.50	0.8	8.0	1.50	0.018	0.070	0.080

Order Information

Packaging

SMD1206 200

Tape & Reel Quantity

Product name Hold Max
Size 3216 mm / 1206 mils Current voltage
SMD: surface mount device 2.00A

005,010,150,200 3500 pcs/reel
020,025,035,050,075,100 3500 pcs/reel

0805

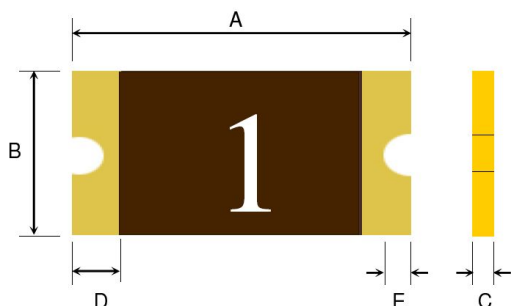

Terminal Pad Solderability:
Meets EIA Specification RS186-9E And ANSI/J-STD-002 Category 3.
Terminal Pad Materials:
Gold-Plated Nickel-Copper or Tin-plated Nickel-Copper Lead-Free, RoHS Compliant

PHYSICAL DIMENSIONS (mm)

Model	Marking	A		B		C		D		E	
		Min.	Max.	Min.	Max.	Min.	Max.	Min.	Max.	Min.	Max.
SMD0805-010	1	2.00	2.20	1.20	1.50	0.50	1.00	0.20	0.10		
SMD0805-020	2	2.00	2.20	1.20	1.50	0.45	1.00	0.20	0.10		
SMD0805-020-24V	2	2.00	2.20	1.20	1.50	0.50	1.20	0.20	0.10		
SMD0805-035	3	2.00	2.20	1.20	1.50	0.45	1.00	0.20	0.10		
SMD0805-050	5	2.00	2.20	1.20	1.50	0.30	0.60	0.20	0.10		
SMD0805-075	7	2.00	2.20	1.20	1.50	0.40	1.00	0.20	0.10		
SMD0805-075	0	2.00	2.20	1.20	1.50	0.50	1.10	0.20	0.10		
SMD0805-100	0	2.00	2.20	1.20	1.50	0.50	1.10	0.20	0.10		
SMD0805-100-12V	0	2.00	2.20	1.20	1.50	0.50	1.20	0.20	0.10		
SMD0805-110	12	2.00	2.20	1.20	1.50	0.50	1.20	0.20	0.10		

ELECTRICAL CHARACTERISTICS

Model	Marking	Vmax (Vdc)	Imax (A)	Ihold @25°C (A)	Itrip @25°C (A)	Pd Typ. (W)	Maximum Time To Trip		Resistance		
							Current	Time (Sec)	Rimin (Ω)	Rityp (Ω)	R1max (Ω)
SMD0805-010	1	15.0	100	0.10	0.30	0.50	0.5	1.50	1.000	2.500	6.000
SMD0805-020	2	9.0	100	0.20	0.50	0.50	8.0	0.02	0.650	1.700	3.500
SMD0805-020-24V	2	9.0	100	0.20	0.50	0.50	8.0	0.02	0.650	1.700	3.500
SMD0805-035	3	6.0	100	0.35	0.75	0.50	8.0	0.10	0.250	0.650	1.200
SMD0805-050	5	6.0	100	0.50	1.00	0.50	8.0	0.10	0.150	0.420	0.850
SMD0805-075	7	6.0	40	0.75	1.50	0.60	8.0	0.20	0.090	0.185	0.385
SMD0805-100	0	6.0	100	1.00	1.95	0.60	8.0	0.30	0.060	0.120	0.230
SMD0805-100-12V	0	12.0	100	1.00	1.95	0.60	8.0	0.30	0.060	0.120	0.230
SMD0805-110	0	6.0	100	1.10	2.20	0.60	8.0	0.30	0.060	-	0.210

Order Information

Packaging

SMD0805 020 -24V

Tape & Reel Quantity

Product name Hold Max
Size 2012 mm / 0805 mils Current voltage
SMD: surface mount device 0.20A

010, 020, 035, 050 5,000 pcs/reel
075, 100, 110, 125 4,000 pcs/reel



1812

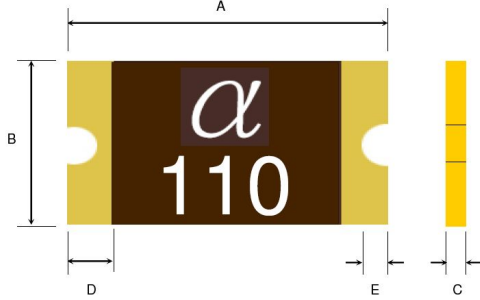

Terminal Pad Solderability:
Meets EIA Specification RS186-9E And ANSI/J-STD-002 Category 3.
Terminal Pad Materials:
Gold-Plated Nickel-Copper Lead-Free, RoHS Compliant

PHYSICAL DIMENSIONS (mm)

Model	A		B		C		D		E
	Min.	Max.	Min.	Max.	Min.	Max.	Min.	Max.	
mSMD010	4.37	4.73	3.07	3.41	0.50	1.00	0.30	0.25	
mSMD014	4.37	4.73	3.07	3.41	0.50	1.00	0.30	0.25	
mSMD020	4.37	4.73	3.07	3.41	0.50	1.00	0.30	0.25	
mSMD030	4.37	4.73	3.07	3.41	0.50	1.00	0.30	0.25	
mSMD050	4.37	4.73	3.07	3.41	0.40	0.90	0.30	0.25	
mSMD075	4.37	4.73	3.07	3.41	0.40	0.90	0.30	0.25	
mSMD110	4.37	4.73	3.07	3.41	0.40	0.90	0.30	0.25	
mSMD125	4.37	4.73	3.07	3.41	0.30	0.80	0.30	0.25	
mSMD150	4.37	4.73	3.07	3.41	0.30	0.80	0.30	0.25	
mSMD160	4.37	4.73	3.07	3.41	0.30	0.80	0.30	0.25	
mSMD200	4.37	4.73	3.07	3.41	0.40	0.80	0.30	0.25	
mSMD260	4.37	4.73	3.07	3.41	0.50	1.10	0.30	0.25	
mSMD300	4.37	4.73	3.07	3.41	0.50	1.20	0.30	0.25	
mSMD350	4.37	4.73	3.07	3.41	0.50	1.20	0.30	0.25	

ELECTRICAL CHARACTERISTICS

Model	Vmax (V)	Imax (A)	Ihold @25°C (A)	Itrip @25°C (A)	Pd Typ. (W)	Maximum Time To Trip		Resistance		
						Current	Time (Sec)	Rimin (Ω)	Rityp (Ω)	R1max (Ω)
mSMD010	30.0	100	0.10	0.30	0.8	0.5	1.50	0.750	2.000	15.000
mSMD014	60.0	100	0.14	0.34	0.8	1.5	0.15	0.650	1.500	6.000
mSMD020	30.0	100	0.20	0.40	0.8	8.0	0.02	0.350	0.800	5.000
mSMD030	30.0	100	0.30	0.60	0.8	8.0	0.10	0.250	0.350	3.000
mSMD050	15.0	100	0.50	1.00	0.8	8.0	0.15	0.150	0.250	1.000
mSMD075	13.2	100	0.75	1.50	0.8	8.0	0.20	0.090	0.150	0.450
mSMD110	8.0	100	1.10	2.20	0.8	8.0	0.30	0.050	0.065	0.250
mSMD110-16V	16.0	100	1.10	2.20	0.8	8.0	0.30	0.050	0.065	0.250
mSMD125	15.0	100	1.25	2.50	0.8	8.0	0.40	0.050	0.075	0.140
mSMD150	8.0	100	1.50	3.00	0.8	8.0	0.50	0.040	0.055	0.160
mSMD150-16V	16.0	100	1.50	3.00	0.8	8.0	0.50	0.040	0.055	0.160
mSMD160	8.0	100	1.60	2.80	0.8	8.0	1.00	0.030	0.050	0.130
mSMD200	8.0	100	2.00	4.00	0.8	8.0	2.00	0.020	0.032	0.100
mSMD260	8.0	100	2.60	5.00	0.8	8.0	2.50	0.015	0.027	0.050
mSMD300	8.0	100	3.00	5.00	0.8	8.0	4.00	0.012	0.027	0.040
mSMD350	6.0	100	3.50	6.00	2.0	10.0	4.00	0.008	-	0.030

Order Information

mSMD		110	Packaging	
Product name	Size 4532 mm / 1812 mils	Hold Current 1.10A	Max voltage	Tape & Reel Quantity
				010,014,020,030,260,300,350 1,500 pcs/reel 050,075,110,150,160,200 2,000 pcs/reel

2920

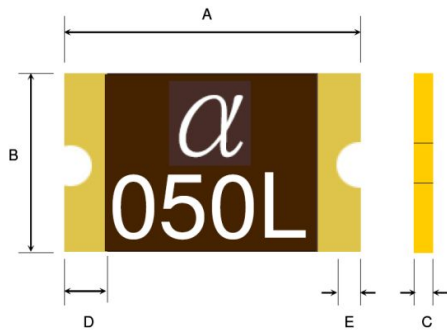

Terminal Pad Solderability:
Meets EIA Specification RS186-9E And ANSI/J-STD-002 Category 3.

Terminal Pad Materials:
Gold-Plated Nickel-Copper or Tin-plated Nickel-Copper Lead-Free, RoHS Compliant

PHYSICAL DIMENSIONS (mm)

Model	Marking	A		B		C		D
		Min.	Max.	Min.	Max.	Min.	Max.	
SMD1210-005	αA	3.00	3.43	2.35	2.80	0.30	0.80	0.30
SMD1210-010	αB	3.00	3.43	2.35	2.80	0.30	0.80	0.30
SMD1210-020	αC	3.00	3.43	2.35	2.80	0.30	0.80	0.30
SMD1210-035	αD	3.00	3.43	2.35	2.80	0.30	0.80	0.30
SMD1210-050	αF	3.00	3.43	2.35	2.80	0.30	0.80	0.30
SMD1210-075	αG	3.00	3.43	2.35	2.80	0.30	0.80	0.30
SMD1210-110	αH	3.00	3.43	2.35	2.80	0.30	0.80	0.30
SMD1210-150	αL	3.00	3.43	2.35	2.80	0.40	0.80	0.30
SMD1210-175	αN	3.00	3.43	2.35	2.80	0.40	0.80	0.30
SMD1210-200	αS	3.00	3.43	2.35	2.80	0.50	1.20	0.30

ELECTRICAL CHARACTERISTICS

Model	Marking	Vmax (V)	Imax (A)	Ihold @25°C (A)	Itrip @25°C (A)	Pd Typ. (W)	Maximum Time To Trip		Resistance		
							Current	Time (Sec)	Rimin (Ω)	Rityp (Ω)	R1max (Ω)
SMD1210-005	αA	30	100	0.05	0.15	0.6	0.25	1.50	2.800	25.000	50.000
SMD1210-010	αB	30	100	0.10	0.30	0.6	0.50	0.60	0.800	5.000	15.000
SMD1210-020	αC	30	100	0.20	0.40	0.6	8.0	0.02	0.400	2.000	5.000
SMD1210-035	αD	6	100	0.35	0.75	0.6	8.0	0.20	0.200	0.550	1.300
SMD1210-050	αF	13.2	100	0.50	1.00	0.6	8.0	0.10	0.180	0.400	0.900
SMD1210-075	αG	6	100	0.75	1.50	0.6	8.0	0.10	0.070	0.130	0.400
SMD1210-110	αH	6	100	1.10	2.20	0.6	8.0	0.30	0.050	0.100	0.210
SMD1210-150	αL	6	100	1.50	3.00	0.6	8.0	0.50	0.030	0.070	0.110
SMD1210-175	αN	6	100	1.75	3.50	0.8	8.0	0.60	0.020	-	0.080
SMD1210-200	αS	6	100	2.00	4.00	0.8	8.0	1.00	0.015	-	0.070

Order Information

SMD1210		010	Packaging	
Product name	Size 3225 mm / 1210 mils	Hold Current 0.10A	Max voltage	Tape & Reel Quantity
				050,075 4000 pcs/reel The others 4500 pcs/reel



5x20面板安装系列

保险丝座 Panel Mount Fuse Holder

编号: 520 012

电流:10A 电压:AC250V

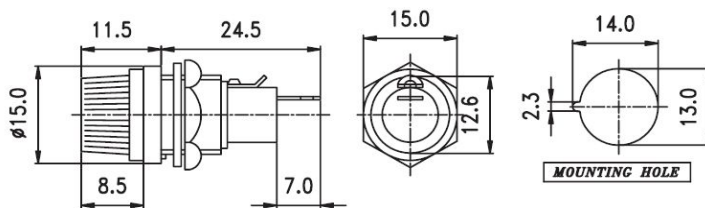

编号: 520 030

电流:6.3A 电压:AC250V

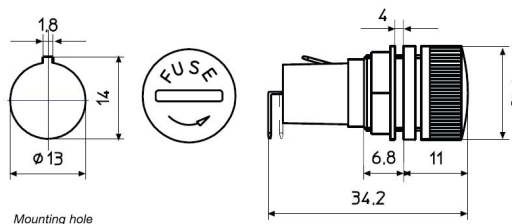

编号: 520 011

电流:10A 电压:AC250V

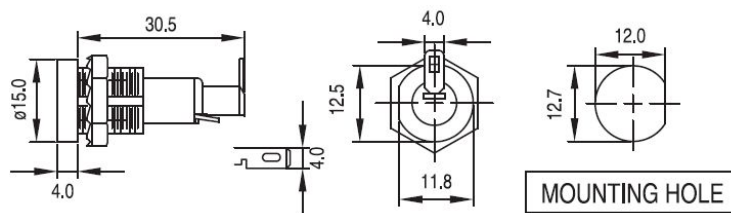

编号: 520 054B

电流:6.3A 电压:AC250V

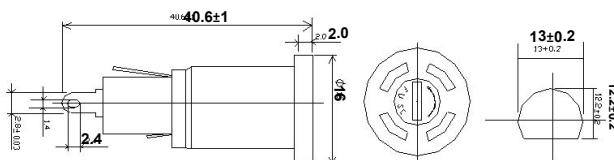

编号: 520 054

电流:6.3A 电压:AC250V

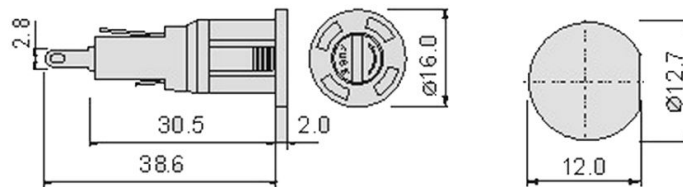

编号: OP520

电流:6.3A 电压:AC250V

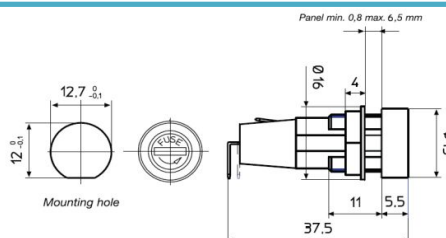



5x20面板安装系列

保险丝座

Panel Mount Fuse Holder

编号: MF527

电流:10A 电压:250V

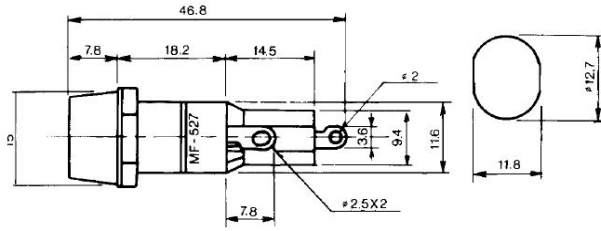

编号: MF528

电流:6.3A 电压:250V

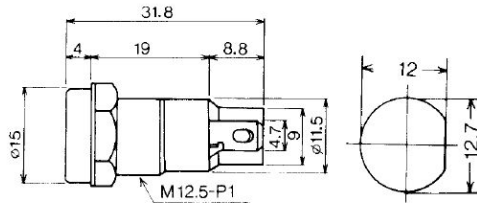

编号: 520 024

电流:10A 电压:250V

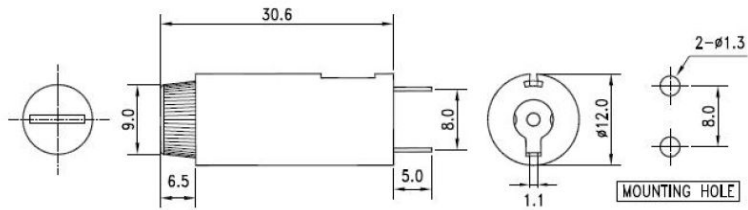

编号: 520 045

电流:10A 电压:250V

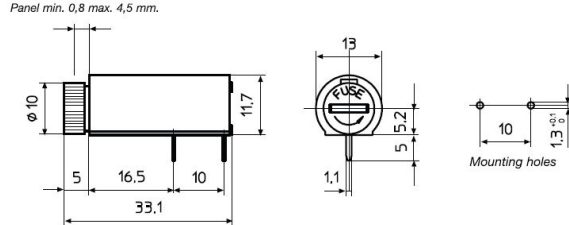

编号: 520 050

电流:10A 电压:250V

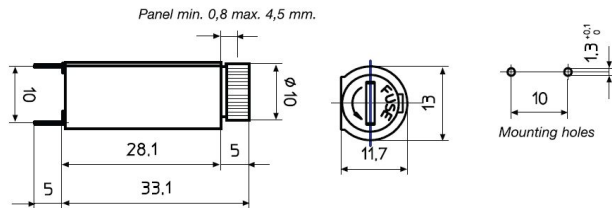

编号: 520 063A

电流:10A 电压:250V

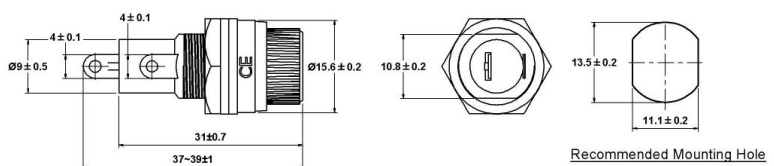



6X30面板安装系列

保险丝座 Panel Mount Fuse Holder

编号: 630 009

电流:15A 电压:250V

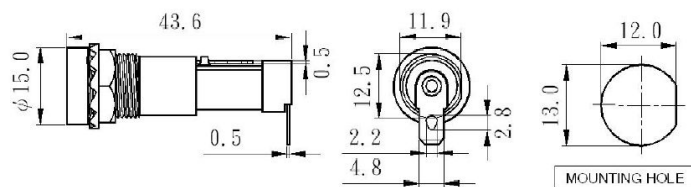

编号: 630 0091

电流:15A 电压:250V

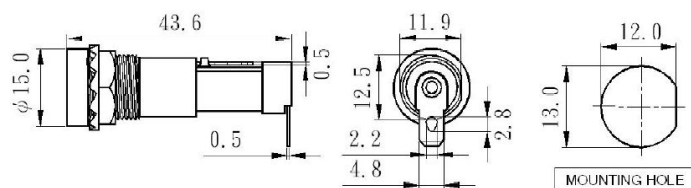

编号: 630 013A

电流:10A 电压:250V

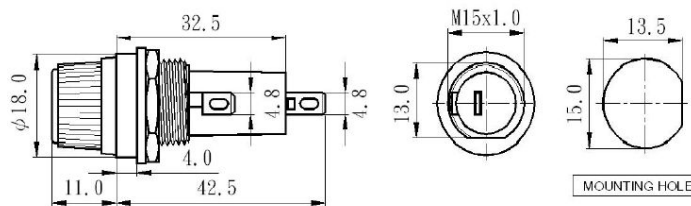

编号: 630 013

电流:10A 电压:250V

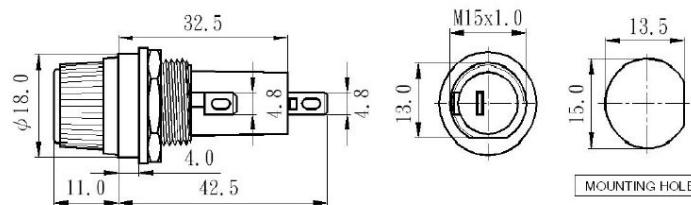

编号: 630 014A

电流:15A 电压:250V

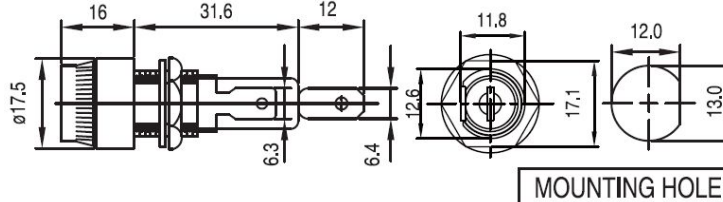

编号: 630 022

电流:15A 电压:250V

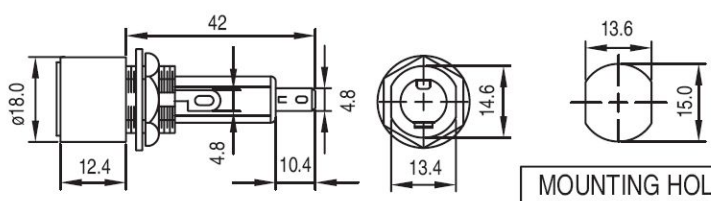



6X30面板安装系列

保险丝座

Panel Mount Fuse Holder

编号: 630 021C

电流:10A 电压:250V

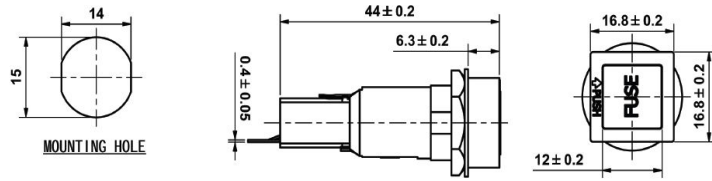

编号: 630 044

电流:15A 电压:250V

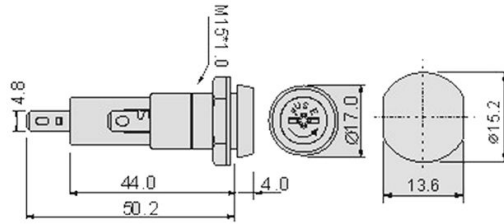

编号: 630 053

电流:20A 电压:250V

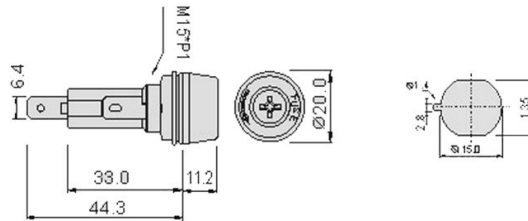

编号: 630 055

电流:20A 电压:250V

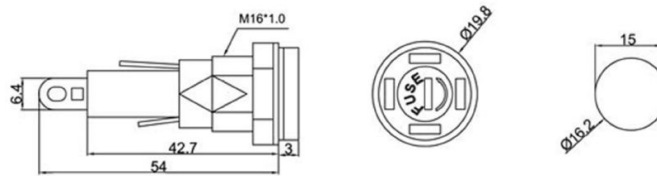

编号: OP530

电流:10A 电压:250V

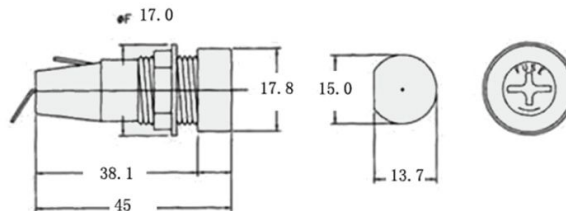

编号: 630 066A

电流:20A 电压:250V





10x38面板安装系列

保险丝座

Panel Mount Fuse Holder

编号: L10 041

电流:30A 电压:600V

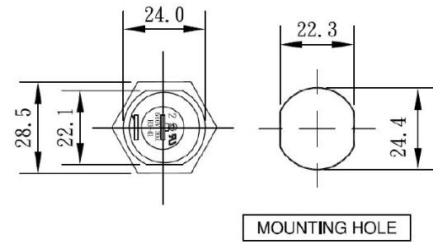
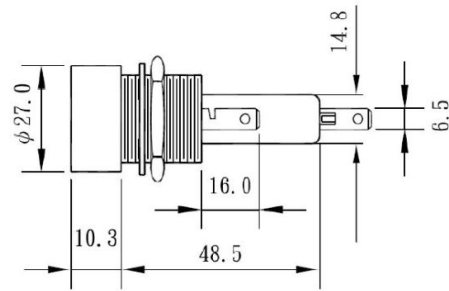

编号: L10 018

电流:30A 电压:600V

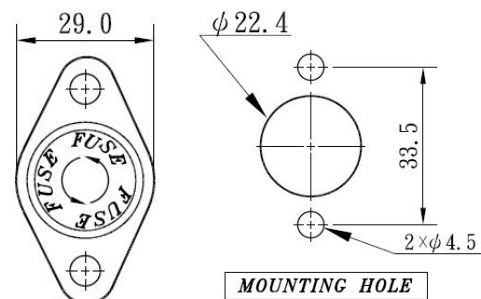
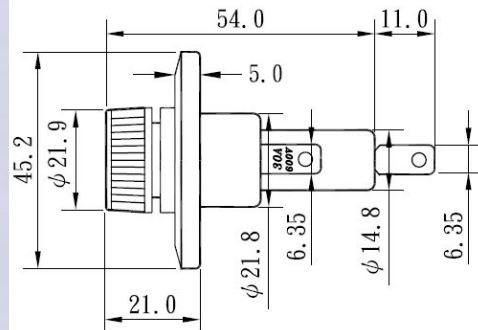



保险丝座 PCB Mount Fuse Holder

编号: 520 F078

电流:10A 电压:250V

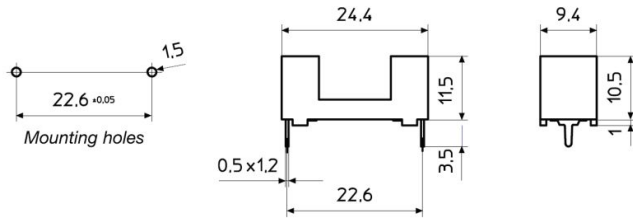
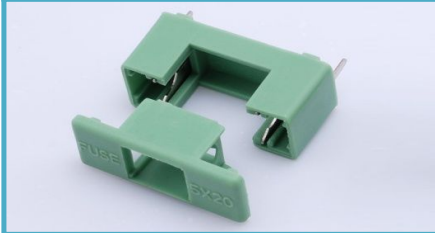

编号: 520 F076

电流:10A 电压:250V

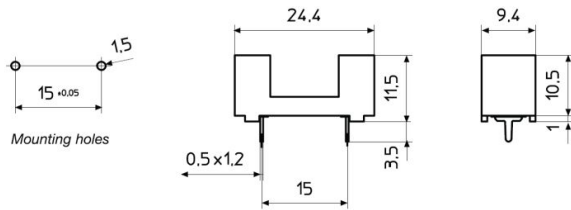

编号: 520 F015

电流:10A 电压:250V

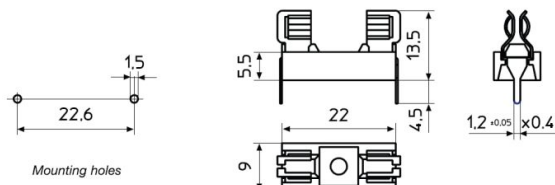
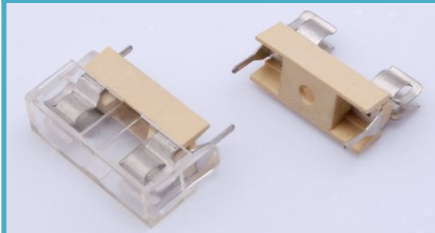

编号: 520 F015H

电流:10A 电压:250V

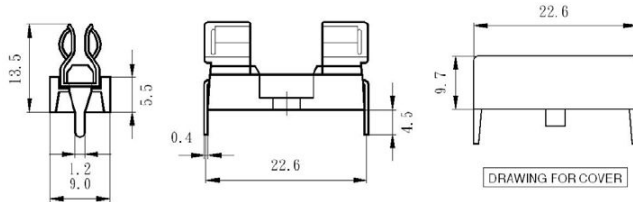
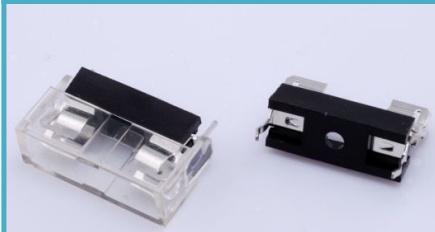

编号: 520 F010

电流:10A 电压:250V

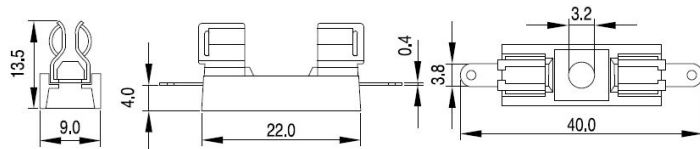
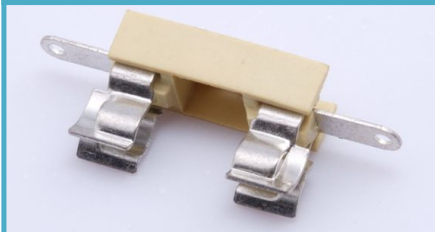

编号: 520 F060

电流:10A 电压:250V

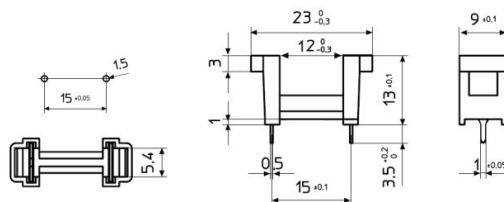



保险丝座 PCB Mount Fuse Holder

编号: 520 F060A

电流:6.3A 电压:250V

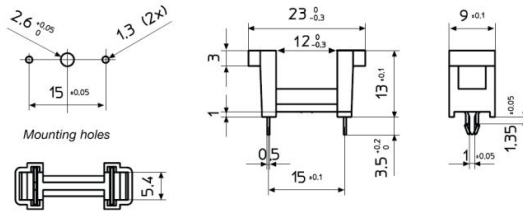

编号: 520 F060B

电流:6.3A 电压:250V

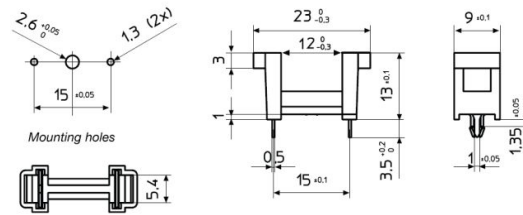
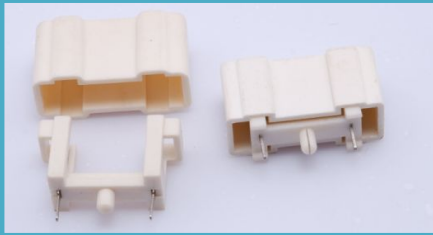

编号: 520 F263

电流:6A 电压:250V

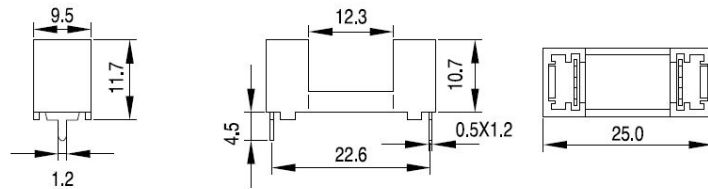
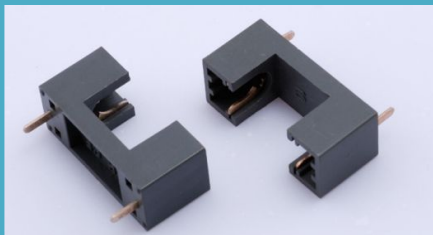

编号: 520 F563

电流:6A 电压:250V

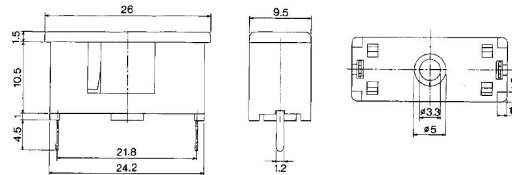

编号: 520 BLX-A

电流:5A 电压:250V

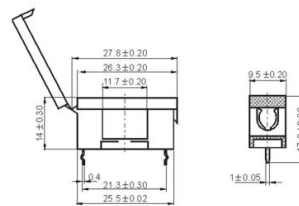
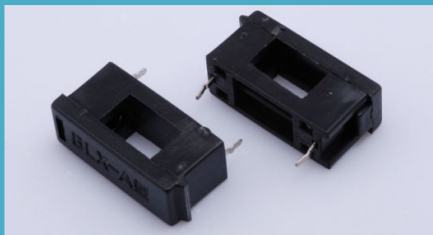





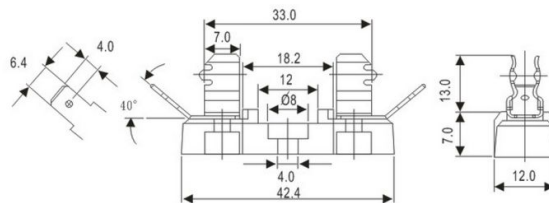
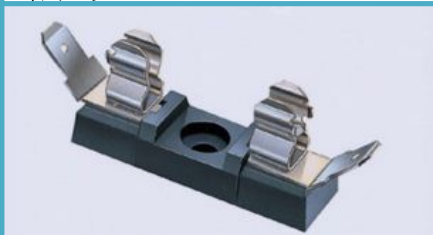





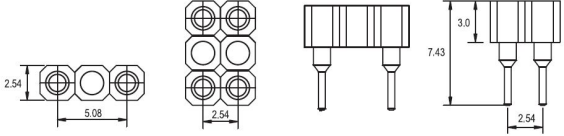
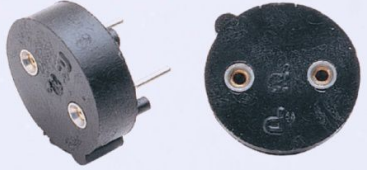

编号: SL 201

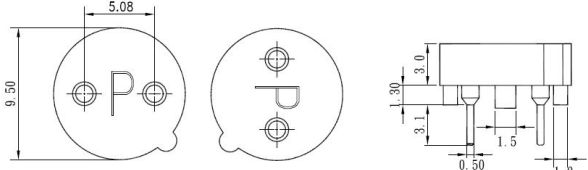
电流:20A 电压:250V

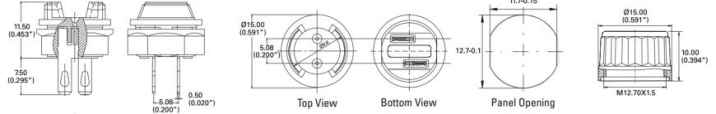
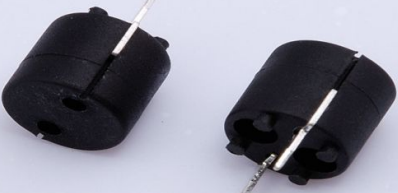

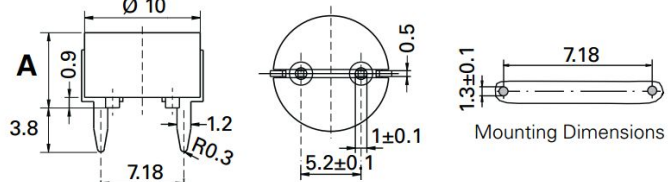

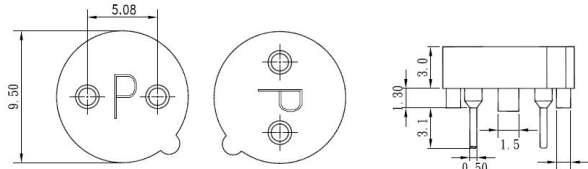

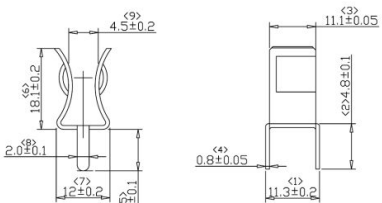



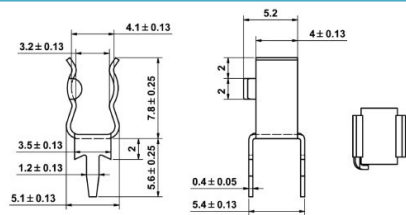
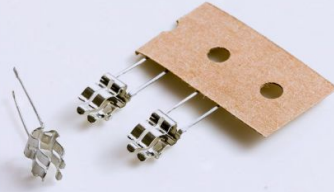
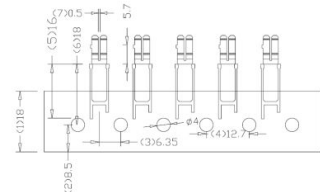

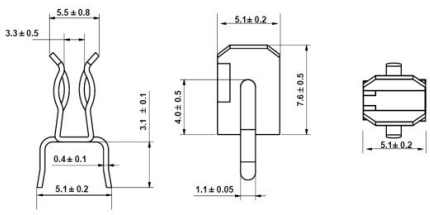
保险丝座 PCB Mount Fuse Holder

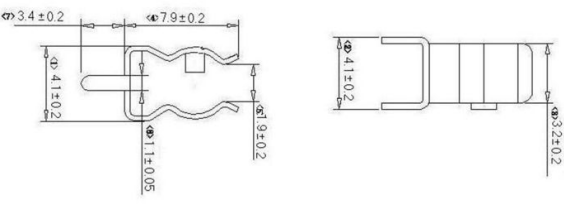
<p>编号: 520 F808</p> 	<p>电流:6.3A 电压:250V  </p> 
<p>编号: 520 F848</p> 	<p>电流:6.3A 电压:250V  </p> 
<p>编号: 520 F570</p> 	<p>电流:6.3A 电压:250V </p> 
<p>编号: 520 F 557</p> 	<p>电流:6.3A 电压:250V </p> 
<p>编号: 520 F560</p> 	<p>电流:6.3A 电压:250V </p> 
<p>编号: SL1038</p> 	<p>电流:30A 电压:250V </p> 

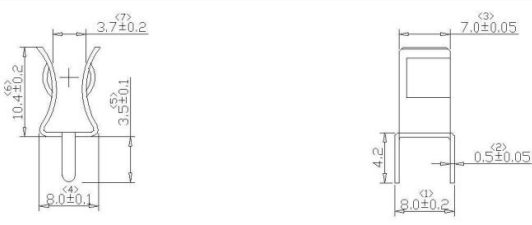

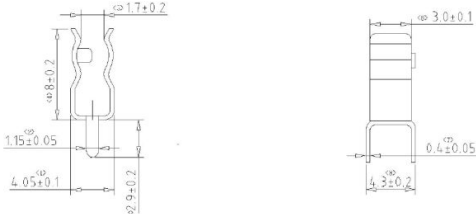
<p>编号: SL520L</p> 	<p>电流:20A 电压:250V</p>  <p>RoHS</p>
<p>编号: SL520 G</p> 	<p>电流:10A 电压:250V</p>  <p>RoHS</p>
<p>编号: SL520H</p> 	<p>电流:10A 电压:250V</p>  <p>RoHS</p>
<p>编号: SL520B</p> 	<p>电流:10A 电压:250V</p>  <p>RoHS</p>
<p>编号: SL520C</p> 	<p>电流:10A 电压:250V</p>  <p>RoHS</p>
<p>编号: SL310</p> 	<p>电流:10A 电压:250V</p>  <p>RoHS</p>



保险丝座 In-line Fuse Holder

编号: SL032 电流:10A 电压:250V

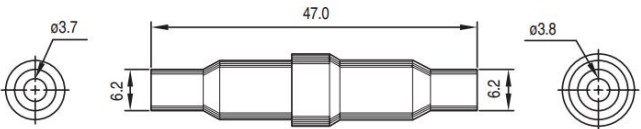
编号: SL048 电流:10A 电压:250V

编号: SL047 电流:10A 电压:250V

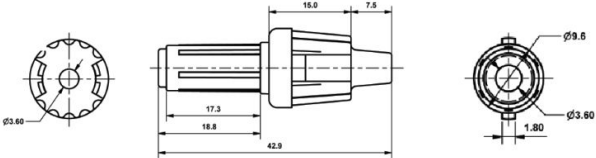
编号: SL046 电流:10A 电压:250V

编号: FX0380 电流:10A 电压:250V

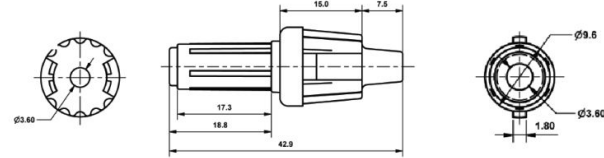
List No.	DIM A
FX0180	60.3
FX0280	54.5
FX0380	48.6

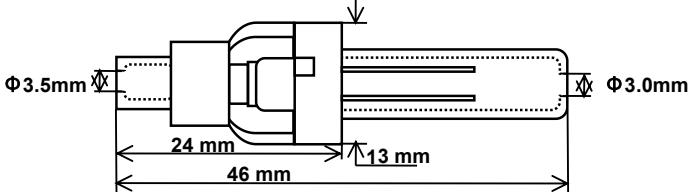
List No.	DIM A
FX0185	91.0
FX0285	85.2
FX0385	79.2

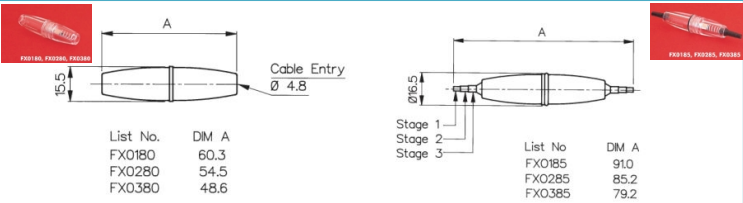



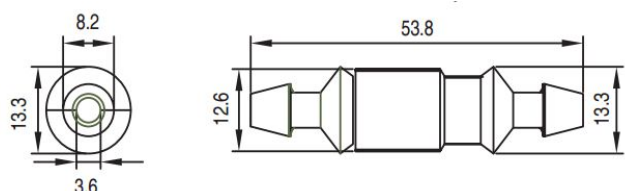







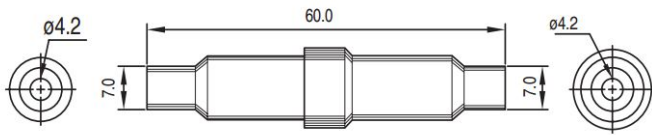

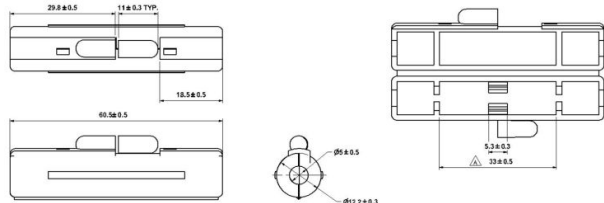

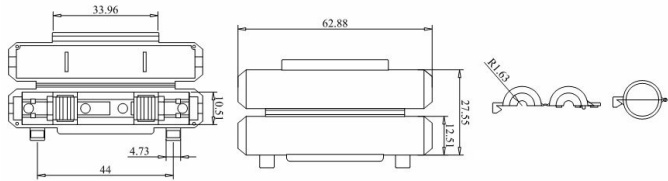
编号: SL712 电流:10A 电压:250V

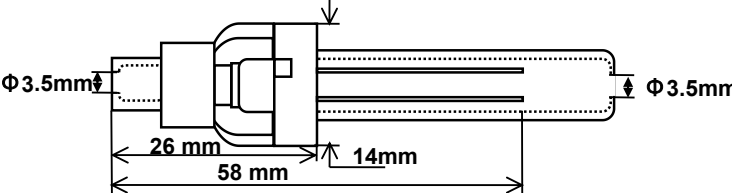

线束安装系列

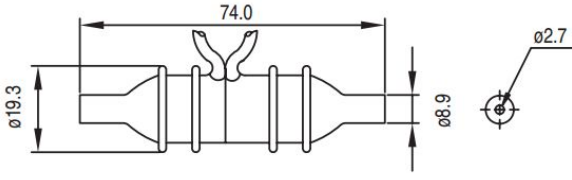
保险丝座 In-line Fuse Holder

<p>编号: SL705D</p> 	<p>电流:10A 电压:250V  </p> 
<p>编号: SL701</p> 	<p>电流:10A 电压:250V </p> 
<p>编号: SL701A</p> 	<p>电流:10A 电压:250V </p> 
<p>编号: SL702</p> 	<p>电流:10A 电压:250V </p> 
<p>编号: SL711</p> 	<p>电流:10A 电压:250V  </p> 
<p>编号: SL705A</p> 	<p>电流:10A 电压:250V  </p> 

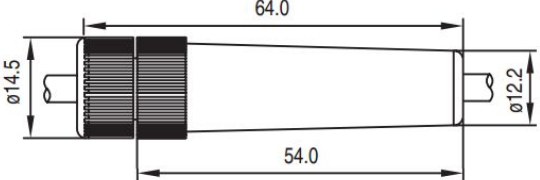

径向引线系列
Radial lead type

温度保险丝
Thermal cutoff Fuse

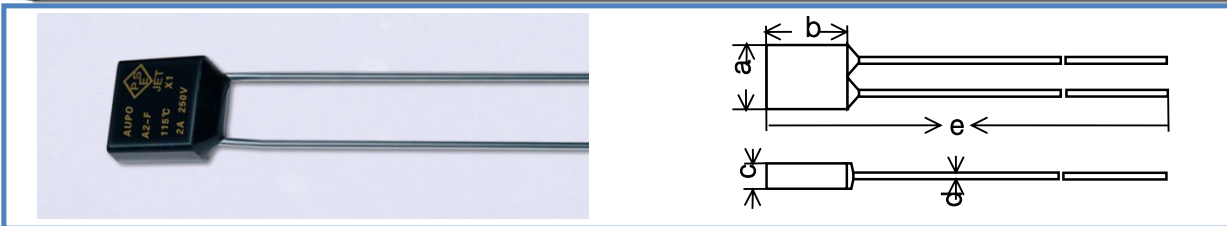

A-F系列	a	b	c	d	e
尺寸单位: MM	6.2±0.5	6.3±0.5	2.5±0.2	0.54±0.05	70±3

型号 Model No.	额定温度 TF	实际动作温度 Fuse temperature	保持温度 TH	极限温度 TM	额定电流 Tr	额定电压 Ur	安规认证 Certification
A1-F	102℃	98±2℃	79℃	203℃	2A	250V	UL CSA VDE PSE CCC KTL ROHS
A2-F	115℃	112±3℃	92℃	203℃	2A	250V	
A3-F	125℃	120±3℃	101℃	203℃	2A	250V	
A4-F	130℃	126±2℃	107℃	203℃	2A	250V	
A5-F	135℃	131±3℃	112℃	203℃	2A	250V	
A7-F	138℃	135±2℃	115℃	203℃	2A	250V	
A8-F	150℃	145±3℃	126℃	203℃	2A	250V	

A-1A-F系列	a	b	c	d	e
尺寸单位: MM	5.2±0.5	4.0±0.5	2.3±0.2	0.54±0.05	70±3

型号 Model No.	额定温度 TF	实际动作温度 Fuse temperature	保持温度 TH	极限温度 TM	额定电流 Tr	额定电压 Ur	安规认证 Certification
A1-1A-F	102℃	98±2℃	76℃	180℃	1A	250V	UL CSA VDE PSE CCC KTL ROHS
A2-1A-F	115℃	112±3℃	85℃	180℃	1A	250V	
A3-1A-F	125℃	120±3℃	97℃	180℃	1A	250V	

A-3A-F系列	a	b	c	d	e
尺寸单位: MM	6.6±0.5	8.0±0.5	2.6±0.2	0.6±0.05	70±3

型号 Model No.	额定温度 TF	实际动作温度 Fuse temperature	保持温度 TH	极限温度 TM	额定电流 Tr	额定电压 Ur	安规认证 Certification
A0-3A-F	84℃	82±2℃	40℃	180℃	3A	250V	UL CSA VDE PSE CCC KTL ROHS
A1-3A-F	102℃	98±2℃	63℃	180℃	3A	250V	
A2-3A-F	115℃	112±3℃	75℃	180℃	3A	250V	
A3-3A-F	125℃	120±3℃	85℃	180℃	3A	250V	
A4-3A-F	130℃	126±2℃	90℃	180℃	3A	250V	
A5-3A-F	135℃	131±3℃	90℃	180℃	3A	250V	
A7-3A-F	138℃	135±2℃	93℃	180℃	3A	250V	
A8-3A-F	150℃	145±3℃	105℃	180℃	3A	250V	

A-5A-F系列	a	b	c	d	e
尺寸单位: MM	6.6±0.5	8.0±0.5	2.6±0.2	0.6±0.05	70±3

型号 Model No.	额定温度 TF	实际动作温度 Fuse temperature	保持温度 TH	极限温度 TM	额定电流 Tr	额定电压 Ur	安规认证 Certification
A0-5A-F	84℃	82±2℃	40℃	180℃	5A	250V	UL CSA VDE PSE CCC KTL ROHS
A1-5A-F	102℃	98±2℃	63℃	180℃	5A	250V	
A2-5A-F	115℃	112±3℃	75℃	180℃	5A	250V	
A3-5A-F	125℃	120±3℃	85℃	180℃	5A	250V	
A4-5A-F	130℃	126±2℃	90℃	180℃	5A	250V	
A5-5A-F	135℃	131±3℃	90℃	180℃	5A	250V	
A7-5A-F	138℃	135±2℃	93℃	180℃	5A	250V	
A8-5A-F	150℃	145±3℃	105℃	180℃	5A	250V	

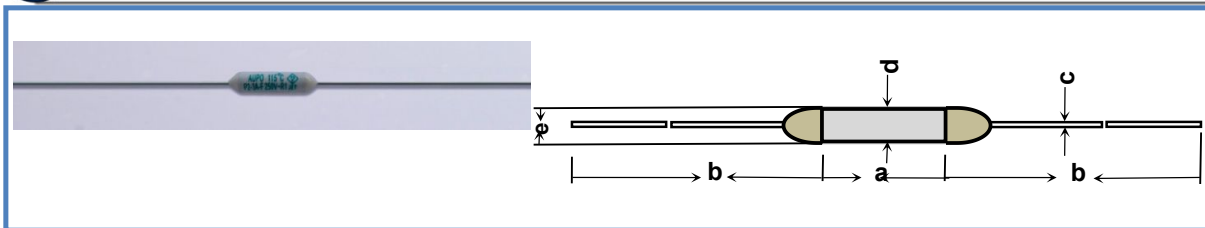

P-F系列	a	b	C	D	E
尺寸单位: MM	9.0±0.5	38±3	0.54±0.02	2.5±0.1	3.0 or below

型号 Model No.	额定温度 TF	实际动作温度 Fuse temperature	保持温度 TH	极限温度 TM	额定电流 Tr	额定电压 Ur	安规认证 Certification
P2-F	115℃	112±3℃	85℃	180℃	2A	250V	UL CSA VDE PSE CCC KTL ROHS
P3-F	125℃	120±3℃	97℃	180℃	2A	250V	
P4-F	130℃	126±2℃	102℃	180℃	2A	250V	
P5-F	135℃	131±3℃	105℃	180℃	2A	250V	
P9-F	138℃	135±2℃	108℃	180℃	2A	250V	
P7-F	150℃	145±3℃	120℃	180℃	2A	250V	

P-1A-F系列	a	b	c	D	E
尺寸单位: MM	6.5±0.5	38±3	0.54±0.02	2.1±0.1	2.4 or below

型号 Model No.	额定温度 TF	实际动作温度 Fuse temperature	保持温度 TH	极限温度 TM	额定电流 Tr	额定电压 Ur	安规认证 Certification
P2-1A-F	115℃	112±3℃	85℃	180℃	1A	250V	UL CSA VDE PSE CCC KTL ROHS
P3-1A-F	125℃	120±3℃	97℃	180℃	1A	250V	
P4-1A-F	130℃	126±2℃	102℃	180℃	1A	250V	
P5-1A-F	135℃	131±3℃	105℃	180℃	1A	250V	
P7-1A-F	138℃	135±2℃	108℃	180℃	1A	250V	
P8-1A-F	150℃	145±3℃	120℃	180℃	1A	250V	

P-3A-F系列	a	b	c	D	E
尺寸单位: MM	10.0±0.5	38±3	0.6±0.02	3.1±0.1	3.3 or below

型号 Model No.	额定温度 TF	实际动作温度 Fuse temperature	保持温度 TH	极限温度 TM	额定电流 Tr	额定电压 Ur	安规认证 Certification
P0-3A-F	84℃	82±2℃	55℃	180℃	3A	250V	UL CSA VDE PSE CCC KTL ROHS
P2-3A-F	115℃	112±3℃	75℃	180℃	3A	250V	
P3-3A-F	125℃	120±3℃	85℃	180℃	3A	250V	
P4-3A-F	130℃	126±2℃	90℃	180℃	3A	250V	
P5-3A-F	135℃	131±3℃	90℃	180℃	3A	250V	
P9-3A-F	138℃	135±2℃	95℃	180℃	3A	250V	
P7-3A-F	150℃	145±3℃	105℃	180℃	3A	250V	

P-5A-F系列	a	b	c	D	E
尺寸单位: MM	11.5±0.5	38±3	0.6±0.02	3.3±0.2	3.6 or below

型号 Model No.	额定温度 TF	实际动作温度 Fuse temperature	保持温度 TH	极限温度 TM	额定电流 Tr	额定电压 Ur	安规认证 Certification
P0-5A-F	84℃	82±2℃	55℃	180℃	5A	250V	UL CSA VDE PSE CCC KTL ROHS
P2-5A-F	115℃	112±3℃	75℃	180℃	5A	250V	
P3-5A-F	125℃	120±3℃	85℃	180℃	5A	250V	
P4-5A-F	130℃	126±2℃	90℃	180℃	5A	250V	
P5-5A-F	135℃	131±3℃	90℃	180℃	5A	250V	
P9-5A-F	138℃	135±2℃	95℃	180℃	5A	250V	
P7-5A-F	150℃	145±3℃	105℃	180℃	5A	250V	



BF感温颗粒系列
BF*** type

温度保险丝 Thermal cutoff Fuse

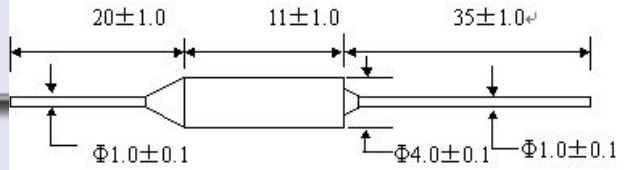

型号 Model No.1	额定温度 TF	实际动作温度 Fuse temperature	保持温度 TH	极限温度 TM	额定电流 Tr	额定电压 Ur	安规认证 Certification					
							UL	CUL	VDE	PSE	CCC	KTl
BF73	73°C	70±2°C	45°C	150°C	10A	250V	●	●	●	●	●	●
BF77	77°C	76+0/-4°C	51°C	150°C	10A	250V	●	●	●	●	●	●
BF84	84°C	82±2°C	58°C	150°C	10A	250V	●	●	●	●	●	●
BF94	94°C	91±3°C	66°C	150°C	10A	250V	●	●	●	●	●	●
BF99	99°C	96±2°C	71°C	150°C	10A	250V	●	●	●	●	●	●
BF104	104°C	100±2°C	79°C	150°C	10A	250V	●	●	●	●	●	●
BF113	113°C	109+3/-1°C	84°C	150°C	10A	250V	●	●	●	●	●	●
BF117	117°C	115±2°C	92°C	160°C	10A	250V	●	●	●	●	●	●
BF121	121°C	119+2/-3°C	94°C	160°C	10A	250V	●	●	●	●	●	●
BF133	133°C	129±2°C	104°C	160°C	10A	250V	●	●	●	●	●	●
BF142	142°C	139+2/-3°C	114°C	160°C	10A	250V	●	●	●	●	●	●
BF157	157°C	152±2°C	127°C	172°C	10A	250V	●	●	●	●	●	●
BF172	172°C	169+3/-1°C	144°C	189°C	10A	250V	●	●	●	●	●	●
BF184	184°C	182+1/-3°C	159°C	210°C	10A	250V	●	●	●	●	●	●
BF192	192°C	188±3°C	170°C	250°C	10A	250V	●	●	●	●	●	●
BF216	216°C	214+2/-3°C	191°C	380°C	10A	250V	●	●	●	●	●	●
BF229	229°C	226+3/-2°C	200°C	380°C	10A	250V	●	●	●	●	●	●
BF240	240°C	235±3°C	200°C	300°C	10A	250V	●	●	●	●	●	●

Terms Explanation

Rated function temperature(Tf):	The temperature at which an electrical or mechanical device operates. According to IEC6091 safety stipulation, thermal fuse must operate at TF +0/-10°C. (DENAN Law regulates the tolerance range ±7°C)
Measured function temperature:	The blowing temperature of the fuse measured in the condition that current is below 10mA and its temperature rises at the rate of 0.5-1°C per minute in a silicon oil bath.
Holding temperature(Th):	The maximum temperature at which its conduction state would not change when the fuse is loaded with rated current for 168 hours.
Maximum temperature(Tm):	The maximum temperature at which the fuse would not reconnect within 10 minutes.
Rated current(lr):	The maximum current the fuse can bear.
Rated voltage(Ur):	The maximum working voltage of the fuse.



BF感温颗粒系列
BF***X type

温度保险丝 Thermal cutoff Fuse

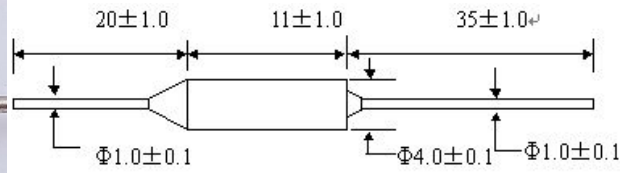

型号 Model No.1	额定温度 TF	实际动作温度 Fuse temperature	保持温度 TH	极限温度 TM	额定电流 Tr	额定电压 Ur	安规认证 Certification		
							VDE	CCC	ROHS
BF73X	73°C	70±2°C	45°C	150°C	16A	250V	●	●	●
BF77X	77°C	76+0/-4°C	51°C	150°C	16A	250V	●	●	●
BF84X	84°C	82±2°C	58°C	150°C	16A	250V	●	●	●
BF94X	94°C	91±3°C	66°C	150°C	16A	250V	●	●	●
BF99X	99°C	96±2°C	71°C	150°C	16A	250V	●	●	●
BF104X	104°C	100±2°C	79°C	150°C	16A	250V	●	●	●
BF113X	113°C	109+3/-1°C	84°C	150°C	16A	250V	●	●	●
BF117X	117°C	115±2°C	92°C	160°C	16A	250V	●	●	●
BF121X	121°C	119+2/-3°C	94°C	160°C	16A	250V	●	●	●
BF133X	133°C	129±2°C	104°C	160°C	16A	250V	●	●	●
BF142X	142°C	139+2/-3°C	114°C	160°C	16A	250V	●	●	●
BF157X	157°C	152±2°C	127°C	172°C	16A	250V	●	●	●
BF172X	172°C	169+3/-1°C	144°C	189°C	16A	250V	●	●	●
BF184X	184°C	182+1/-3°C	159°C	210°C	16A	250V	●	●	●
BF192X	192°C	188±3°C	170°C	250°C	16A	250V	●	●	●
BF216X	216°C	214+2/-3°C	191°C	380°C	16A	250V	●	●	●
BF229X	229°C	226+3/-2°C	200°C	380°C	16A	250V	●	●	●
BF240X	240°C	235±3°C	200°C	300°C	16A	250V	●	●	●

Terms Explanation

Rated function temperature(Tf):	The temperature at which an electrical or mechanical device operates. According to IEC6091 safety stipulation, thermal fuse must operate at TF +0/-10°C. (DENAN Law regulates the tolerance range ±7°C)
Measured function temperature:	The blowing temperature of the fuse measured in the condition that current is below 10mA and its temperature rises at the rate of 0.5-1°C per minute in a silicon oil bath.
Holding temperature(Th):	The maximum temperature at which its conduction state would not change when the fuse is loaded with rated current for 168 hours.
Maximum temperature(Tm):	The maximum temperature at which the fuse would not reconnect within 10 minutes.
Rated current(lr):	The maximum current the fuse can bear.
Rated voltage(Ur):	The maximum working voltage of the fuse.



BF感温颗粒系列
BF***-I type

温度保险丝
Thermal cutoff Fuse

UL cUL PSE **ROHS**
S

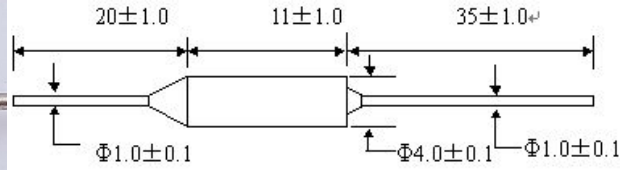

型号 Model No.1	额定温度 TF	实际动作温度 Fuse temperature	保持温度 TH	极限温度 TM	额定电流 Tr	额定电压 Ur	安规认证 Certification			
							UL	CUL	PSE	ROHS
BF73-I	73℃	70±2℃	45℃	150℃	16A	125V	●	●	●	●
BF77-I	77℃	76+0/-4℃	51℃	150℃	16A	125V	●	●	●	●
BF84-I	84℃	82±2℃	58℃	150℃	16A	125V	●	●	●	●
BF94-I	94℃	91±3℃	66℃	150℃	16A	125V	●	●	●	●
BF99-I	99℃	96±2℃	71℃	150℃	16A	125V	●	●	●	●
BF104-I	104℃	100±2℃	79℃	150℃	16A	125V	●	●	●	●
BF113-I	113℃	109+3/-1℃	84℃	150℃	16A	125V	●	●	●	●
BF117-I	117℃	115±2℃	92℃	160℃	16A	125V	●	●	●	●
BF121-I	121℃	119+2/-3℃	94℃	160℃	16A	125V	●	●	●	●
BF133-I	133℃	129±2℃	104℃	160℃	16A	125V	●	●	●	●
BF142-I	142℃	139+2/-3℃	114℃	160℃	16A	125V	●	●	●	●
BF157-I	157℃	152±2℃	127℃	172℃	16A	125V	●	●	●	●
BF172-I	172℃	169+3/-1℃	144℃	189℃	16A	125V	●	●	●	●
BF184-I	184℃	182+1/-3℃	159℃	210℃	16A	125V	●	●	●	●
BF192-I	192℃	188±3℃	170℃	250℃	16A	125V	●	●	●	●
BF216-I	216℃	214+2/-3℃	191℃	380℃	16A	125V	●	●	●	●
BF229-I	229℃	226+3/-2℃	200℃	380℃	16A	125V	●	●	●	●
BF240-I	240℃	235±3℃	200℃	300℃	16A	125V	●	●	●	●

Terms Explanation

Rated function temperature(Tf):	The temperature at which an electrical or mechanical device operates. According to IEC6091 safety stipulation, thermal fuse must operate at TF +0/-10℃. (DENAN Law regulates the tolerance range ±7℃)
Measured function temperature:	The blowing temperature of the fuse measured in the condition that current is below 10mA and its temperature rises at the rate of 0.5-1℃ per minute in a silicon oil bath.
Holding temperature(Th):	The maximum temperature at which its conduction state would not change when the fuse is loaded with rated current for 168 hours.
Maximum temperature(Tm):	The maximum temperature at which the fuse would not reconnect within 10 minutes.
Rated current(lr):	The maximum current the fuse can bear.
Rated voltage(Ur):	The maximum working voltage of the fuse.

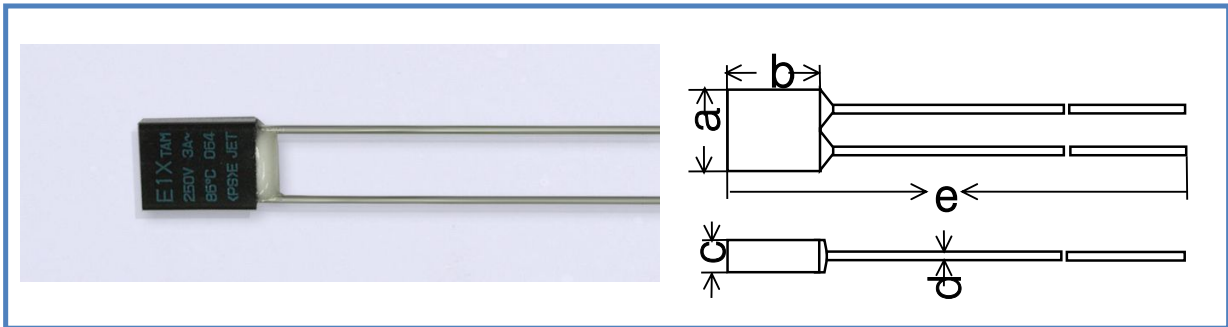

型号:	a	b	c	d	e	尺寸单位
N-F	5.2±0.1	4.1±0.1	2.0±0.1	0.53±0.5	36±3.0 (NF) 68±3.0 (NF-L)	MM
H-F	6.7±0.1	5.9±0.1	2.5±0.1	0.55±0.05	36±3.0 (HF) 68±3.0 (HF-L)	
E-F	6.6±0.1	8.5±0.1	2.5±0.1	0.7±0.05	36±3.0 (EF) 68±3.0 (EF-L)	

额定温度 TF	实际动作温度 Fuse temperature	N-F		电压 V	电流 A	H-F		电压 V	电流 A	E-F		电压 V	电流 A
65°C	61±3°C	N06F	AC	250V	1A	H06F	AC	250V	2.5A	E06F	AC	250V	3A
76°C	72±3°C	N0F	AC	250V	1A	H0F	AC	250V	2.5A	E0F	AC	250V	3A
			DC	50	2.5A		125V	3A	125V		4A		
86°C	81±2°C	N1F	AC	250V	1A	H1F	AC	250V	2.5A	E1F	AC	250V	3A
			DC	50	2.5A		125V	3A	125V		4A		
102°C	98±3°C	N2F	AC	250V	1A	H2F	AC	250V	3A	E2F	AC	250V	3A
			DC	50	3A		125	3.5A	125		5.5A		
115°C	111±2°C	N3F	AC	250V	1A	H3F	AC	250V	3A	E3F	AC	250V	3A
			DC	50	3A		125	3.5A	125		5.5A		
127°C	123±2°C	N4F	AC	250V	1A	H4F	AC	250V	3A	E4F	AC	250V	3A
			DC	50	3A		125	3.5A	125		5.5A		
133°C	129±3°C	N13F	AC	250V	1A	H13F	AC	250V	3A	E13F	AC	250V	3A
			DC	50	4A		125	3.5A	125		5.5A		
136°C	131±2°C	N5F	AC	250V	1A	H5F	AC	250V	3A	E5F	AC	250V	3A
			DC	50	3A		125	3.5A	125		5.5A		
139°C	134±2°C	N6F	AC	250V	1A	H6F	AC	250V	2.5A	E6F	AC	250V	3A
			DC	50	3A		125	3.5A	125		5.5A		
145°C	140±2°C	K7F	AC	250V	1A	H7F	AC	250V	2A	E7F	AC	250V	3A
			DC	50	3A		125	3.5A	125		5.5A		



轴向引线系列
Axial lead type

田村温度保险丝
TAMURA Thermal cutoff Fuses

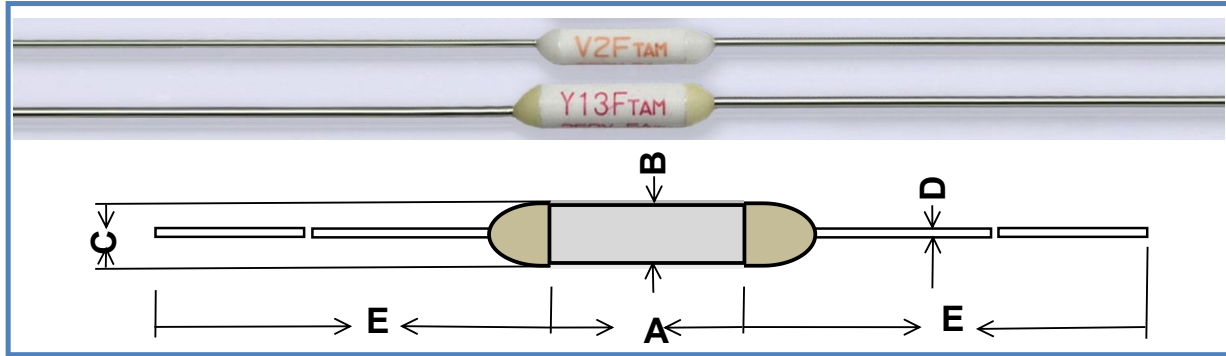

型号:	A	B	C	D	E	尺寸单位
K-F	6.0±0.3	1.5±0.1	1.8 and under	0.53±0.05	68±3.0 (KF) 38±3.0 (KF-C)	MM
T-F	6.3±0.3	2.0±0.1	2.3 and under	0.53±0.05	68±3.0 (TF) 38±3.0 (TF-C)	
V-F	8.9±0.3	2.5±0.1	3.0 and under	0.58±0.05	68±3.0 (VF) 38±3.0 (VF-C)	
Y-F	10.0±0.3	3.0±0.2	3.3 and under	0.70±0.05	68±3.0 (YF) 38±3.0 (YF-C)	
L-F	11.5±0.7	3.3±0.2	3.6 and under	1.0±0.05	68±3.0 (LF) 38±3.0 (LF-C)	

额定温度 TF	实际动作温度 Fuse temperature	K-F		T-F		V-F		Y-F		L-F							
		电压 V	电流 A	电压 V	电流 A	电压 V	电流 A	电压 V	电流 A	电压 V	电流 A						
65°C	61±3°C	K06F	AC 250	1.0	T06F	A 250	1.0	V06F	A 250	3.0	Y06F	AC 250	4.0	L06F	AC 250	4.0	
76°C	72±3°C	K0F	AC	250	1.0	T0F	A	250	1.0	V0F	A	250	2.0	Y0F	AC	250	4.0
			DC	50	2.0		C	125	2.0		C	125	3.5		DC	50	6.0
86°C	81±2°C	K1F	AC	250	1.0	T1F	A	250	1.0	V1F	A	250	2.0	Y1F	AC	250	5.0
			DC	50	2.0		C	125	2.0		C	125	3.5		DC	50	6.5
102°C	98±3°C	K2F	AC	250	1.0	T2F	A	250	2.0	V2F	A	250	3.0	Y2F	AC	250	5.0
			DC	50	3.0		C	125	3.0		C	125	4.0		DC	50	6.0
115°C	111±2°C	K3F	AC	250	1.0	T3F	A	250	2.0	V3F	A	250	3.0	Y3F	AC	250	5.0
			DC	50	3.0		C	125	3.0		C	125	4.0		DC	50	6.0
127°C	123±2°C	K4F	AC	250	1.0	T4F	A	250	2.0	V4F	A	250	3.0	Y4F	AC	250	5.0
			DC	50	3.0		C	125	3.0		C	125	4.0		DC	50	6.0
133°C	129±3°C	K13F	AC	250	1.0	T13F	A	250	2.0	V13F	A	250	3.0	Y13F	AC	250	5.0
			DC	50	3.0		C	125	3.0		C	125	4.0		DC	50	6.0
136°C	131±2°C	K5F	AC	250	1.0	T5F	A	250	2.0	V5F	A	250	3.0	Y5F	AC	250	5.0
			DC	50	3.0		C	125	3.0		C	125	4.0		DC	50	6.0



轴向 径向导线型
LEseries

田村温度保险丝
TAMURA Thermal cutoff
Fuses

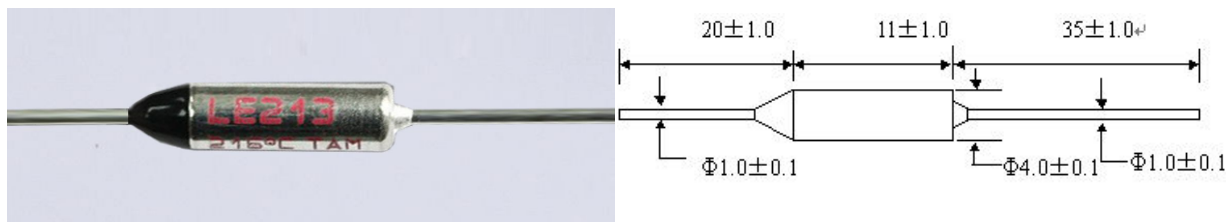

型号 Model No.1	额定温度 TF	实际动作温度 Fuse temperature	保持温度 TH	极限温度 TM	额定电流 Tr	额定电压 Ur	安规认证 Certification						
							UL	VDE	BEA B	PSE	CCC	KTLS	ROHS
LE070	73℃	71±2℃	50℃	150℃	15A	250V	●	●	●	●	●	●	●
LE073	77℃	74±2℃	50℃	150℃	15A	250V	●	●	●	●	●	●	●
LE080	84℃	80±2℃	50℃	150℃	15A	250V	●	●	●	●	●	●	●
LE0090	94℃	91±3℃	65℃	150℃	15A	250V	●	●	●	●	●	●	●
LE095	99℃	95±2℃	71℃	150℃	15A	250V	●	●	●	●	●	●	●
LE108	113℃	109±2℃	85℃	150℃	15A	250V	●	●	●	●	●	●	●
LE117	121℃	117±3℃	95℃	160℃	15A	250V	●	●	●	●	●	●	●
LE124	128℃	124±3℃	102℃	160℃	15A	250V	●	●	●	●	●	●	●
LE128	133℃	129+3-2℃	105℃	160℃	15A	250V	●	●	●	●	●	●	●
LE138	157℃	138±2℃	110℃	172℃	15A	250V	●	●	●	●	●	●	●
LE152	172℃	152+3-1℃	130℃	189℃	15A	250V	●	●	●	●	●	●	●
LE169	184℃	167+1-3℃	145℃	210℃	15A	250V	●	●	●	●	●	●	●
LE189	192℃	189±3℃	165℃	250℃	15A	250V	●	●	●	●	●	●	●
LE213	216℃	213±2℃	190℃	380℃	15A	250V	●	●	●	●	●	●	●

Terms Explanation

Rated function temperature(Tf):	The temperature at which an electrical or mechanical device operates. According to IEC6091 safety stipulation, thermal fuse must operate at TF +0/-10℃. (DENAN Law regulates the tolerance range ±7℃)
Measured function temperature:	The blowing temperature of the fuse measured in the condition that current is below 10mA and its temperature rises at the rate of 0.5-1℃ per minute in a silicon oil bath.
Holding temperature(Th):	The maximum temperature at which its conduction state would not change when the fuse is loaded with rated current for 168 hours.
Maximum temperature(Tm):	The maximum temperature at which the fuse would not reconnect within 10 minutes.
Rated current(lr):	The maximum current the fuse can bear.
Rated voltage(Ur):	The maximum working voltage of the fuse.

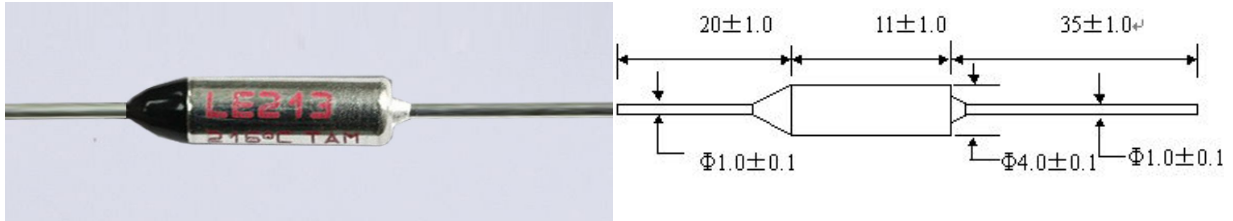

型号 Model No.1	额定温度 TF	实际动作温度 Fuse temperature	保持温度 TH	极限温度 TM	额定电流 Tr	额定电压 Ur	安规认证 Certification						
							UL	VDE	BEA B	PSE	CCC	CTL	ROHS
LE070T	73℃	71±2℃	50℃	150℃	10A	250V	●	●	●	●	●	●	●
LE073T	77℃	74±2℃	50℃	150℃	10A	250V	●	●	●	●	●	●	●
LE080T	84℃	80±2℃	50℃	150℃	10A	250V	●	●	●	●	●	●	●
LE0090T	94℃	91±3℃	65℃	150℃	10A	250V	●	●	●	●	●	●	●
LE095T	99℃	95±2℃	71℃	150℃	10A	250V	●	●	●	●	●	●	●
LE108T	113℃	109±2℃	85℃	150℃	10A	250V	●	●	●	●	●	●	●
LE117T	121℃	117±3℃	95℃	160℃	10A	250V	●	●	●	●	●	●	●
LE124T	128℃	124±3℃	102℃	160℃	10A	250V	●	●	●	●	●	●	●
LE128T	133℃	129+3-2℃	105℃	160℃	10A	250V	●	●	●	●	●	●	●
LE138T	157℃	138±2℃	110℃	172℃	10A	250V	●	●	●	●	●	●	●
LE152T	172℃	152+3-1℃	130℃	189℃	10A	250V	●	●	●	●	●	●	●
LE169T	184℃	167+1-3℃	145℃	210℃	10A	250V	●	●	●	●	●	●	●
LE189T	192℃	189±3℃	165℃	250℃	10A	250V	●	●	●	●	●	●	●
LE213T	216℃	213±2℃	190℃	380℃	10A	250V	●	●	●	●	●	●	●

Terms Explanation

Rated function temperature(Tf):	The temperature at which an electrical or mechanical device operates. According to IEC6091 safety stipulation, thermal fuse must operate at TF +0/-10℃. (DENAN Law regulates the tolerance range ±7℃)
Measured function temperature:	The blowing temperature of the fuse measured in the condition that current is below 10mA and its temperature rises at the rate of 0.5-1℃ per minute in a silicon oil bath.
Holding temperature(Th):	The maximum temperature at which its conduction state would not change when the fuse is loaded with rated current for 168 hours.
Maximum temperature(Tm):	The maximum temperature at which the fuse would not reconnect within 10 minutes.
Rated current(lr):	The maximum current the fuse can bear.
Rated voltage(Ur):	The maximum working voltage of the fuse.

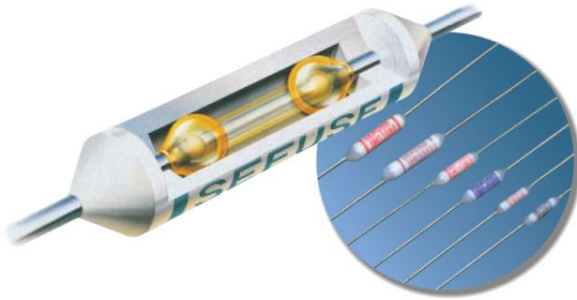

SM/A Series

■ Dimension (Unit:mm)

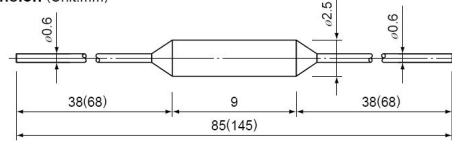

The SM type uses a fusible alloy inside a ceramic case. It has a cutoff(rated) current of 2 A. Because of its insulated case, the SM type can be attached directly where temperature detection is required.

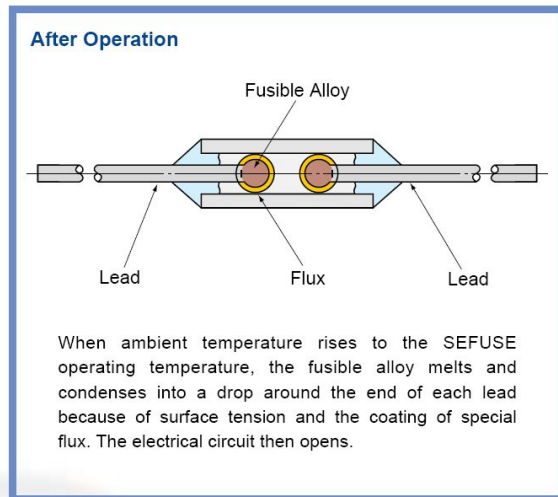
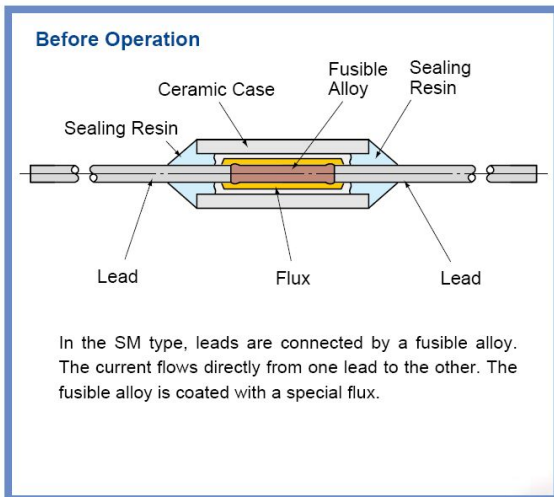

■ Ratings

Part Number	Rated Functioning Temperature $T_F \sim T_f$ (°C)	Operating Temperature (°C)	T_H T_{Th} (°C)	T_M T_{Tm} (°C)	Rated Current	Rated Voltage	U L	CSA	VDE	BEAB	CCIB	CCEE	△
SM072A0	76	$72 \pm \frac{3}{2}$	46	100	2 A (Resistive)	AC250V	E71747	172780 (LR52330)	File No. 6778.2 -1171 -0001	C1054	2001 LV2618	CH 0045038 -2000	33-528
SM095A0	100	$95 \pm \frac{5}{8}$	65	115									33-466
SM110A0	115	110 ± 2	80	125									33-472
SM126A0	131	126 ± 2	96	140									33-467
SM130A0	135	130 ± 2	100	145									
SM134A0	139	134 ± 2	—	—									
SM145A0	150	145 ± 2	115	160									33-468
SM164A0	169	$164 \pm \frac{3}{2}$	133	180									33-470
SM182A0	187	182 ± 2	152	195									33-556

Note: 1) Part numbers are for standard devices. For long leads, change the last number from 0 to 1.
2) SM072A has C-UL recognition.
3) The number in parentheses are previous number. Both number can be inquired.



SF有机物系列
SF10A 250V Series

温度保险丝 Thermal cutoff Fuse

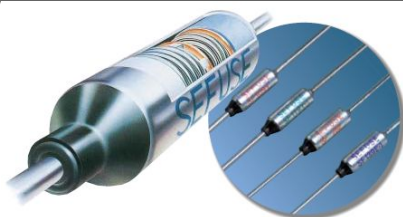

Dimension (Unit:mm)

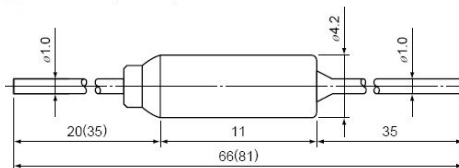

The SF type uses an organic thermosensitive pellet inside a metal case. It features large cutoff(rated) current of 10 A or 15 A.

Note: The dimensions for long lead devices are in parentheses.

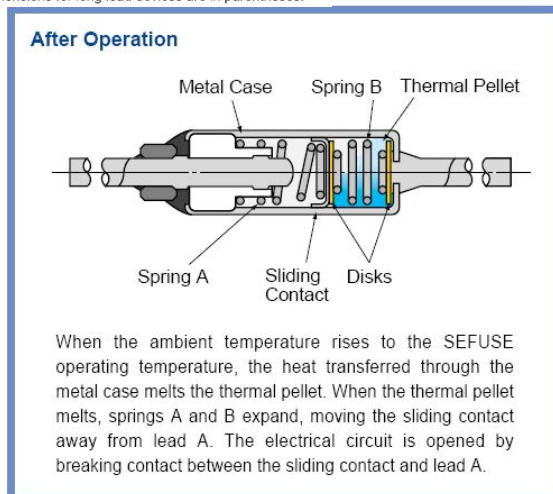
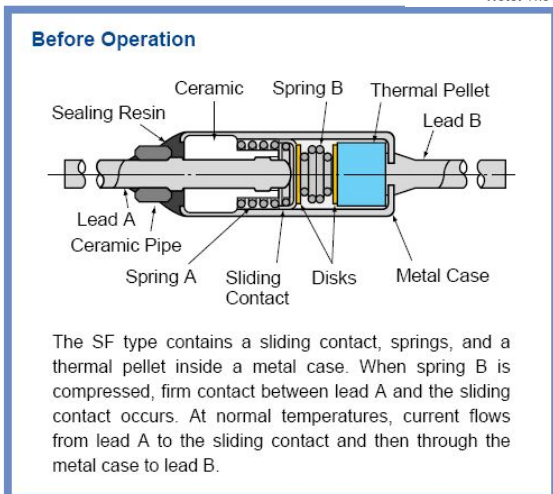

Ratings

Part Number	1) Rated Functioning Temperature T _F •T _f (°C)	Operating Temperature (°C)	T _H Th (°C)	T _M T _m (°C)	Rated Current	Rated Voltage	U	L	CSA	VDE	BEAB	CCIB	CCEE	△							
														Made in Japan	Made in Thailand						
SF 70E	73	70 ± 2	45	150	4) 15A / 10A (Resistive)	4) AC250V	E71747		6) 172780 (LR52330)	File No. 6778.2 -1171 -0002	C1060	Made in Japan 2001 LV2618	Made in Japan CH 0045037 -2000	33-312	33-835						
SF 76E	77	76 ± 2	51	150										33-331	33-834						
SF 91E	94	91 ± 2	66	150										33-332	33-833						
SF 96E	99	96 ± 2	71	150										33-333	33-832						
SF109E	113	109 ± 2	84	150										33-334	33-831						
SF119E	121	119 ± 2	94	150										33-335	33-830						
SF129E	133	129 ± 2	104	159										33-336	33-886						
SF139E	142	139 ± 2	114	159										33-549	33-827						
SF152E	157	152 ± 2	127	172										33-354	33-828						
SF169E	172	169 ± 2	144	189										5)			6) Licence No. Made in Japan 081640 Made in Thailand 097299	Made in Thailand 2001 LV2561	Made in Thailand CH 0045041 -2000		
SF188E	192	188 ± 2	164	300																	
SF214E	216	214 ± 2	200 ²⁾	350																	
SF226E	227	226 ± 2	200 ²⁾	300 ³⁾																	
SF240E	240	237 ± 2	200 ²⁾	350																	

Note: 1) Part numbers are for standard lead devices. For long leads, add the number "-1" at the end of part number.

2) Th approved by BEAB is 189 °C for SF214E and 190 °C for SF226E and SF240E.

3) T_M approved by UL is 240 °C. T_m approved by CSA is 330 °C.

4) The electrical ratings by safety standards are as follows.

Rated Voltage	Japan	UL	CSA	VDE	BEAB	CCIB	CCEE
AC120V		15A (Inductive) 20A (Resistive)					
AC240V		15A (Resistive)					
AC250V	10A	10A (Resistive) 15A (Resistive) 17A (Resistive)	15A (Inductive) 15A (Resistive)	10A	10A	10A	10A
AC277V		15A (Resistive)					

5) SF169E, SF188E, SF214E, SF226E and SF240E has a recognition of CH rating by UL.

6) The number in parentheses are previous number. Both number can be inquired.



SF有机物系列
SF15A 250V type

温度保险丝 Thermal cutoff Fuse

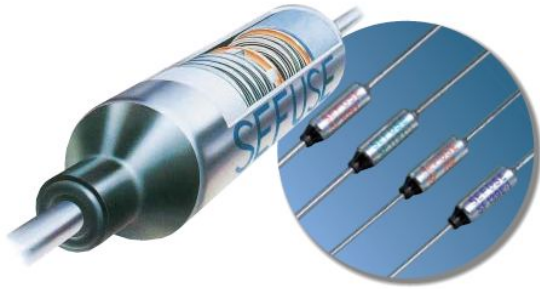

■ Dimension (Unit:mm)

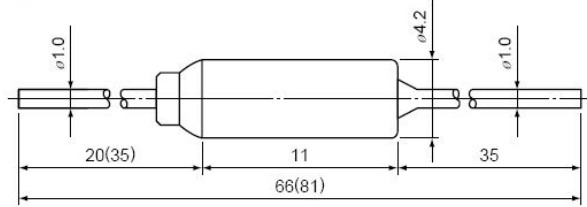

Note: The dimensions for long lead devices are in parentheses.

The SF type uses an organic thermosensitive pellet inside a metal case. It features a large cutoff(rated) current of 15 A 250VAC

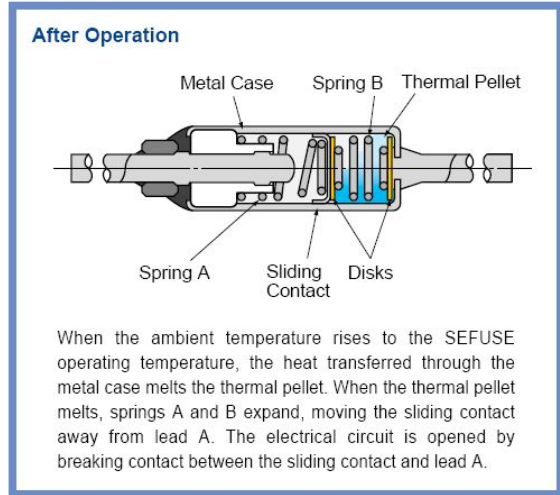
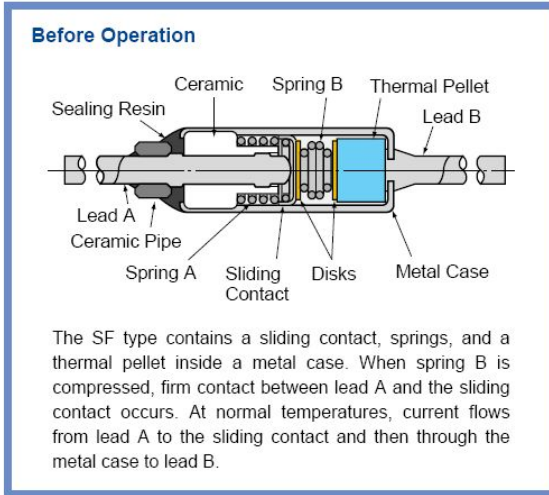

■ Ratings

Part Number ¹⁾	Rated Functioning Temperature	Operating Temperature	Rated Current	Rated Voltage	UL
SF 70Y	73°C	70 ± 2°C	15A	AC250V	E71747
SF 76Y	77°C	76 ± 1°C			
SF 91Y	94°C	91 ± 1°C			
SF 96Y	99°C	96 ± 2°C			
SF109Y	113°C	109 ± 1°C			
SF119Y	121°C	119 ± 2°C			
SF129Y	133°C	129 ± 2°C			E71747
SF139Y	142°C	139 ± 2°C			
SF152Y	157°C	152 ± 2°C			
SF169Y	172°C	169 ± 1°C			
SF188Y	192°C	188 ± 1°C			
SF214Y	216°C	214 ± 1°C			
SF226Y	227°C	226 ± 1°C	E71747		
SF240Y	240°C	237 ± 2°C			

Note: 1) Part numbers are for standard lead devices. For long leads, add the number "-1" at the end of part number.

- All the parts and materials don't contain lead (Pb).
- Cadmium free contact types are available. Please contact us.



It protects against overheating in:

- Shaded Pole Motor
- Permanent split capacitor motor
- Fluorescent lighting ballasts
- HID ballasts
- Transformers
- Recessed lighting fixtures
- Battery packs
- Vacuum cleaners
- Automotive accessory motors, solenoids, PC boards

The 17AM Thermal protector uses the same snap-action principle of other KLIXON protectors. The bimetal disc senses both heat and current from the equipment which 17AM is installed on. When the temperature of the disc reaches a predetermined calibration point, the disc snaps open the contacts, thus breaking the current path. When the equipment returns to a normal operating range, the 17AM resets (close circuit) automatically.

Certificates

UL CSA VDE CE CQC RoHS

Nominal Parameter

22 A / 115 V--- AC
 9 A / 250 V--- AC
 20 A / 16 V--- DC
 Temperature Range
 65 °C~ 150 °C, ±5°C (in the increments of 5°C)
 Life cycles: 10,000 (10000 automatic resets)

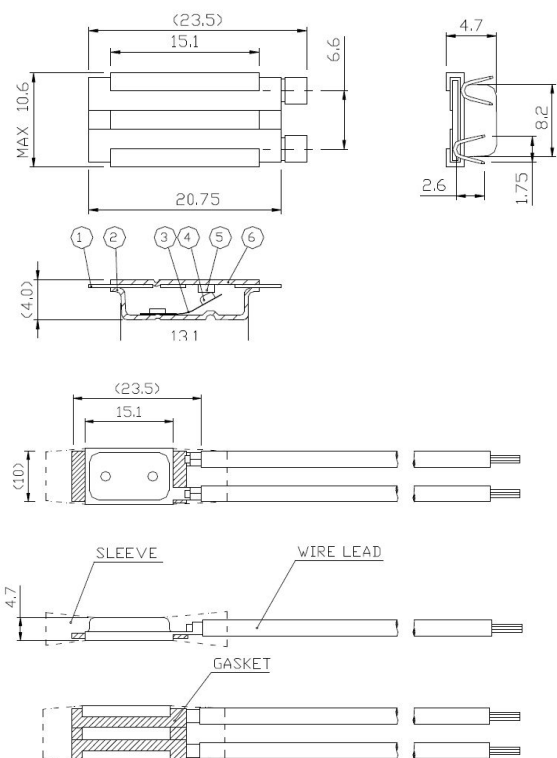

Category	UL	ENEC	CQC
Motor Protector	E15962	2014531.05	CQC0200 2001332
Ballast for Fluorescent and Thermal Cut Out	E34618	2014531.05	-
Temperature Sensing Controls	E34618	2014531.05	-

Part No.	Tripping Temperature
17AM 020	65°C±5°C
17AM 021	70°C±5°C
17AM 022	75°C±5°C
17AM 023	80°C±5°C
17AM 024	85°C±5°C
17AM 025	90°C±5°C
17AM 026	95°C±5°C
17AM 027	100°C±5°C
17AM 028	105°C±5°C
17AM 029	110°C±5°C
17AM 030	115°C±5°C
17AM 031	120°C±5°C
17AM 032	125°C±5°C
17AM 033	130°C±5°C
17AM 034	135°C±5°C
17AM 035	140°C±5°C
17AM 036	145°C±5°C
17AM 037	150°C±5°C
17AM 038	155°C±5°C
17AM 039	160°C±5°C



15x7.3x3.9
15x6.6x3.2

BH Series

温度开关 Thermal Protector

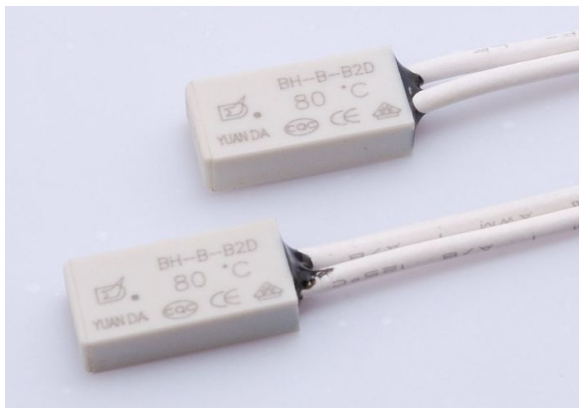

BH thermal protector applies to:

- fan motors
- transformers
- fluorescent lamp ballast
- batteries
- electronics and electrical equipments
- household and similar equipments

BH Nominal Parameter

Ir/Ur: 6A250V~; 8A125V~
 Temperature range
 45°C~150°C, in the increments of 5°C
 Max temperature:150°C
 Life cycles: 10,000 (10000 automatic resets)

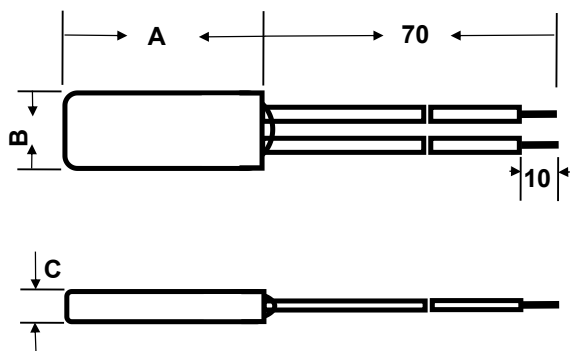

Type	A	B	C
A metal case	15±0.3	6.6±0.2	3.2±0.1
B plastic case	15±0.3	7.3±0.2	3.9±0.1

Part No.	Tripping Temperature
045	45°C±5°C
050	50°C±5°C
055	55°C±5°C
060	60°C±5°C
065	65°C±5°C
070	70°C±5°C
075	75°C±5°C
080	80°C±5°C
085	85°C±5°C
090	90°C±5°C
095	95°C±5°C
100	100°C±5°C
105	105°C±5°C
110	110°C±5°C
115	115°C±5°C
120	120°C±5°C
125	125°C±5°C
130	130°C±5°C
135	135°C±5°C
140	140°C±5°C
145	145°C±5°C
150	150°C±5°C



20x7.3x3.9
20x6.6x3.2

BW Series

温度开关 Thermal Protector



BW thermal protector applies to:

- fan motors
- transformers
- fluorescent lamp ballast
- batteries
- electronics and electrical equipments
- household and similar equipments

BW Nominal Parameter

Ir/Ur: 8A250V~; 12A125V~
 Temperature range
 40°C~150°C, in the increments of 5°C
 Max temperature:150°C
 Life cycles: 10,000 (10000 automatic resets)

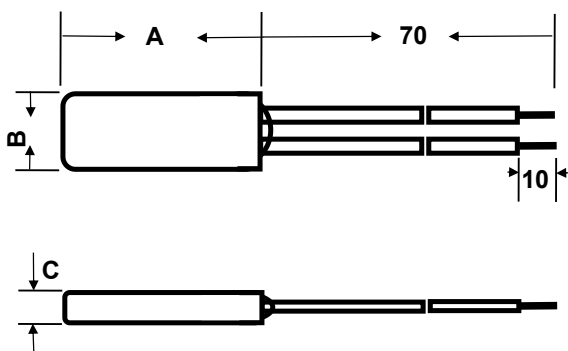

Type	A	B	C
A metal case	20±0.3	6.6±0.2	3.2±0.1
B plastic case	20±0.3	7.3±0.2	3.9±0.1

Part No.	Tripping temperature
040	40°C±5°C
045	45°C±5°C
050	50°C±5°C
055	55°C±5°C
060	60°C±5°C
065	65°C±5°C
070	70°C±5°C
075	75°C±5°C
080	80°C±5°C
085	85°C±5°C
090	90°C±5°C
095	95°C±5°C
100	100°C±5°C
105	105°C±5°C
110	110°C±5°C
115	115°C±5°C
120	120°C±5°C
125	125°C±5°C
130	130°C±5°C
135	135°C±5°C
140	140°C±5°C
145	145°C±5°C
150	150°C±5°C



13.5x5.4x2.4

TB02 Series

温度开关

Thermal Protector



TB02 thermal protector applies to:

- fan motors
- transformers
- fluorescent lamp ballast
- batteries
- electronics and electrical equipments
- household and similar equipments

TB02 Nominal Parameter

Ir/Ur: 2A250V~; 3A125V~
 Temperature range
 40°C~150°C, in the increments of 5°C
 Max temperature:150°C
 Life cycles: 10,000 (10000 automatic resets)

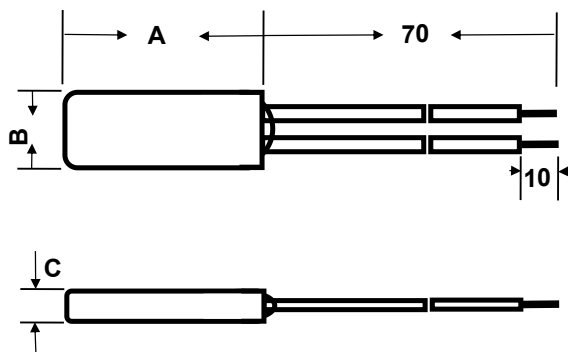

Type	A	B	C
A metal case	1.3.5±0.3	5.4±0.1	2.4±0.1
B plastic case	13.5±0.25	5.4±0.1	2.4±0.1

Part No.	Tripping temperature
040	40°C±5°C
045	45°C±5°C
050	50°C±5°C
055	55°C±5°C
060	60°C±5°C
065	65°C±5°C
070	70°C±5°C
075	75°C±5°C
080	80°C±5°C
085	85°C±5°C
090	90°C±5°C
095	95°C±5°C
100	100°C±5°C
105	105°C±5°C
110	110°C±5°C
115	115°C±5°C
120	120°C±5°C
125	125°C±5°C
130	130°C±5°C
135	135°C±5°C
140	140°C±5°C
145	145°C±5°C
150	150°C±5°C



Constructure and application:

KSD301 snap action thermostat is the small-size bimetal thermostat series with a metal cap, which belongs to thermalrelays family. The main principle is the function of bimetal discs snap action under the change of temperature sensed. The snap action of disc can push the action of the contacts through the inside structure, causing the circuit on and off finally.

Widely used in household water dispensers, electric heaters, disinfection cabinets, coffee pots, rice cookers, air conditioners, laminators, and other heating equipments.

Advantages:

high stability, high accuracy, small volume, long life cycles, high reliability, little radio interference.

Technical specification:

- parameters:
 - VDE, CQC, UL, TÜV AC250V 50~60Hz 10 (Resistive load)
 - UL AC125V 50Hz 15A (Resistive load)
- Action temperature: 0~220°C, tolerance: ± (2~5%) °C
- Reset temperature: 3~100°C
- Mode of connecting: terminal 250#(0~90°); terminal 187# (0~90°, thickness: 0.5, 0.8mm)
- Life: 1)VDE, UL 100000 cycles
2)CQC, TÜV 10000 cycles
- Electric strength: AC2000V under 1min, no flash, no breakdown
- Contact resistance: ≤50mΩ
- Insulation resistance: ≤100MΩ
- Contact form: normally closed (NC) and normally open(NO)
- Protection grade: IP00
- Grounding mode: by connecting the metal case with appliance grounding metal part
- Installation: KSD301 is mounted with moving reticle, (attached with aluminium cap with mounting hole)

Model No.	Tf	Model No.	Tf
010	45±5°C	026	150±5°C
011	50±5°C	027	155±5°C
012	55±5°C	028	160±5°C
013	60±5°C	029	165±5°C
010	65±5°C	030	170±5°C
011	70±5°C	031	175±5°C
012	75±5°C	032	180±5°C
013	80±5°C	031	175±5°C
014	85±5°C	032	180±5°C
015	90±5°C	below is high temperature	
016	95±5°C	033	185±5°C
017	100±5°C	034	190±5°C
018	105±5°C	035	195±5°C
019	110±5°C	036	200±5°C
020	115±5°C	037	205±5°C
021	120±5°C	038	210±5°C
022	125±5°C	039	215±5°C
023	130±5°C	040	220±5°C
024	135±5°C	041	215±5°C
025	140±5°C	042	220±5°C

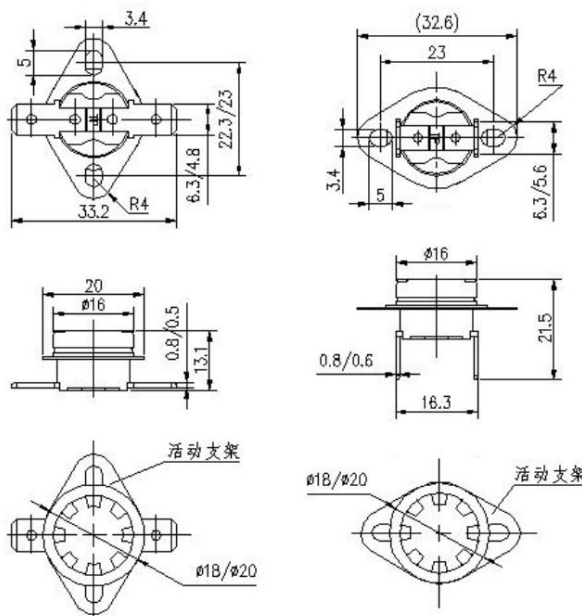

Opening temperature can be made as request:
±2°C ±3°C ±5°C



SEKI 热保护器

温度开关

SEKI Series ST-22/ST-12 Thermal Protector



ST-22



SEKI ST-22 thermal protector applies to:

- fan motors
- transformers
- fluorescent lamp ballast
- batteries
- electronics and electrical equipments
- household and similar equipments

SEKI ST-22 Nominal Parameter

Ir/Ur: 8A250V~; 13A125V~

Temperature range

45°C~150°C, in the increments of 5°C

Max temperature:150°C

Life cycles: 10,000 (10000 automatic resets)

Certificates:

UL CSA VDE CQC RoHS

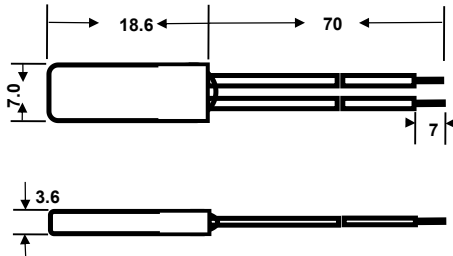

Model No.	Tripping temperature	Model No.	Tripping temperature
ST-22 45	45°C	ST-22 100	100°C
ST-22 50	50°C	ST-22 105	105°C
ST-22 55	55°C	ST-22 110	110°C
ST-22 60	60°C	ST-22 115	115°C
ST-22 65	65°C	ST-22 120	120°C
ST-22 70	70°C	ST-22 125	125°C
ST-22 75	75°C	ST-22 130	130°C
ST-22 80	80°C	ST-22 135	135°C
ST-22 85	85°C	ST-22 140	140°C
ST-22 90	90°C	ST-22 145	145°C
ST-22 95	95°C	ST-22 150	150°C

ST-12



SEKI ST-12 thermal protector applies to:

- blowers, hair divider, electric ovens, corn poppers, electric heaters, tableware dryers

SEKI ST-12 Nominal Parameter

Ir/Ur: 10A250V~; 15A125V~

Temperature range

70°C~150°C, in the increments of 5°C

Max temperature:150°C

Life cycles: 6000 (6000 automatic resets)

ON-OFF temperature tolerance: below 10°C

Contact capacity:

Minimum: 100mA /cycle, Maximum: 30A/cycle

Certificates:

UL CSA VDE CQC RoHS

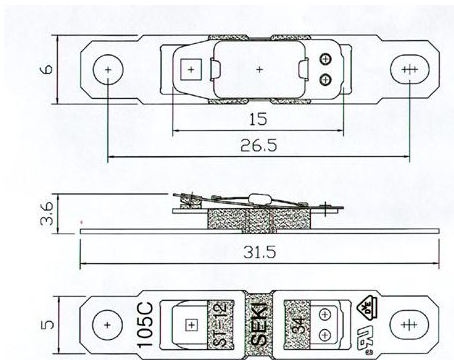

Model No.	Tripping temperature	Model No.	Tripping temperature
ST-12 70	70°C	ST-12 115	115°C
ST-12 75	75°C	ST-12 120	120°C
ST-12 80	80°C	ST-12 125	125°C
ST-12 85	85°C	ST-12 130	130°C
ST-12 90	90°C	ST-12 135	135°C
ST-12 95	95°C	ST-12 140	140°C
ST-12 100	100°C	ST-12 145	145°C
ST-12 105	105°C	ST-12 150	150°C
ST-12 110	110°C		

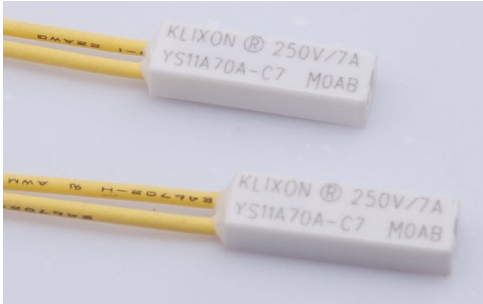

YS11 thermal protector applies to:

motors, batteries, chargers, battery packs, transformers, instruments, equipments, PC boards, household appliances

YS11 is a temperature sensing protector developed by Klixon. YS11 is very sensitive to temperature change. When temperature rises to a certain point, the bimetal strip will open instantly; When the equipment returns to a normal operating range, the YS11 resets (close circuit) automatically

Certificates:

UL CSA VDE CE CQC RoHS

Nominal parameters

10A / 115 V--AC (10000 automatic resets)

7A / 240 V--AC (10000 automatic resets)

6A / 24V-- DC (10000 automatic resets)

13A / 30V-- DC (3000 automatic resets)

Temperature range: 45 °C~ 150 °C ±5°C (in the increments of 5°C);

Case dimension(L×W×T): 21.5×6.9×4.0 mm

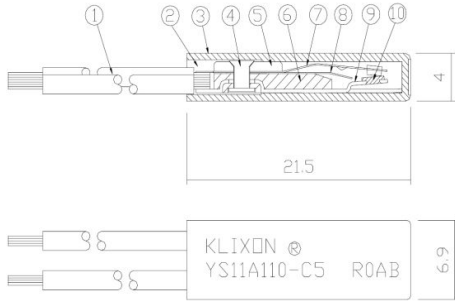

Model No.	Tripping Temperature	Model NO.	Tripping Temperature
YS11A 45	45°C	YS11A 100	100°C
YA11A 50	50°C	YS11A 105	105°C
YS11A 55	55°C	YS11A 110	110°C
YS11A 60	60°C	YS11A 115	115°C
YS11A 65	65°C	YS11A 120	120°C
YS11A 70	70°C	YS11A 125	125°C
YS11A 75	75°C	YS11A 130	130°C
YS11A 80	80°C	YS11A 135	135°C
YS11A 85	85°C	YS11A 140	140°C
YS11A 90	90°C	YS11A 145	145°C
YS11A 95	95°C	YA11A 150	150°C

TP1 thermal protector



Applications:

low-power motors, coils, water pump, fluorescent lamp ballast, transformers, lighting, household appliances

Advantages:

Diamond structure, small volume, easy to install

long life cycles

highly sensitive to current and temperature, fast response

multi-style assembly structure: can be made single, double t, triple, quadruple and six-combined as request.

Nominal parameters:

Rated voltage: 50/60HZ, 250V, AC

Rated current: 2.5(1.6)A/10(6.3)A , COSφ=1.0(0.6)

Opening temperature range:+60°C~+160°C, 5°C increments

TECHNICAL SPECIFICATION

Model number		TP1	
Ur: 50/60HZ		220-250V	
Ir:	COS φ=1.0	2.5A	10.0A
	COS φ=0.6	1.6A	6.3A
AC MAX LOAD	500V 50/60HZ	3.5A	8.0A
	380V 50/60HZ	4.0A	10.5A
	250V 50/60HZ	6.3A	16A
	110V 50/60HZ	10.0A	36.0A
DC MAX LOAD	60V	1.0A	4.0A
	42V	1.2A	4.8A
	6V 12V 24V	1.5A	6.0A



Mini 插片保险丝 mini blade fuse

汽车保险丝 AUTO Fuse

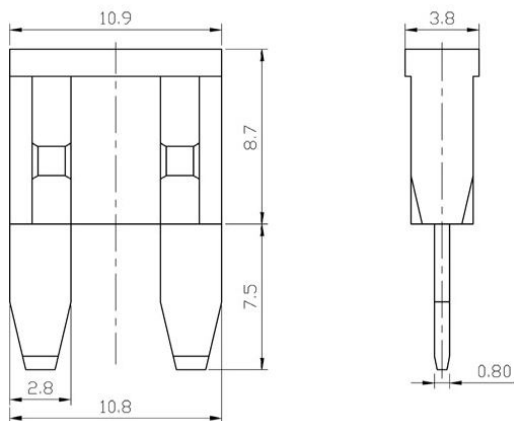

Rated voltage: 32V (can reach 58V with special material)
 Breaking capacity: 1000A@32V DC
 Operating temperature: -40°C~+125°C
 Material; I: zinc alloy II: plastic
 Standards: SAE J2077, JASO, D612, ISO 8820-3, QC/T 420

Time-Current Characteristic

I _r %	Blowing time	
	minimum	maximum
110%	100h	---
135%	0.75s	1,800s
200%	0.15s	5s
350%	0.04s	0.5s
600%	0.02s	0.1s

Rating

Part No.	I _r (A)	Shell color
ATN 2	2 A	
ATN 3	3 A	
ATN 4	4 A	
ATN 5	5 A	
ATN 7.5	7.5 A	
ATN 10	10 A	
ATN 15	15 A	
ATN 20	20 A	
ATN 25	25 A	
ATN 30	30 A	
ATN 35	35 A	

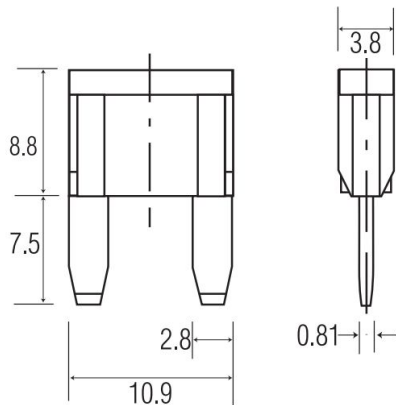

Interrupting Rating: 1000A @ 32 VDC
 Voltage Rating: 32 VDC
 Operating Temperature Range: -40°C to +125°C
 Terminals: Ag plated zinc alloy
 Housing Materials: PA66
 Complies with: Meets SAE J2077
 ISO 8820-3
 UL 248 Special Purpose Fuse



Time-Current Characteristic

I _r %	Opening Time Min / Max (s)
110	360,000 s /
135	0.75 s / 600 s
200	0.15 s / 5 s
350	0.080 s / 0.250 s
600	0.030 s / 0.100 s

Rating

Part No.	I _r (A)	Shell color
297002	2 A	
297003	3 A	
ATN 4	4 A	
ATN 5	5 A	
ATN 7.5	7.5 A	
ATN 10	10 A	
ATN 15	15 A	
ATN 20	20 A	
ATN 25	25 A	
ATN 30	30 A	



中型插片保险丝
medium blade fuse

汽车保险丝
AUTO Fuse

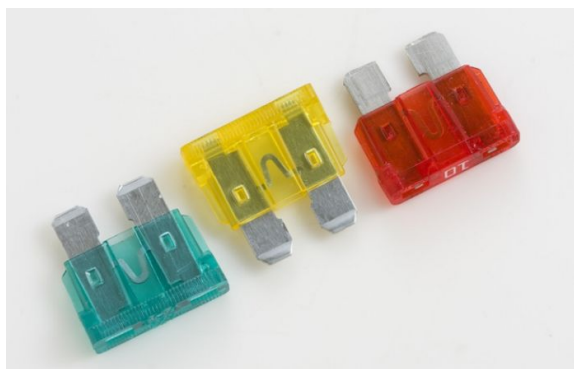

Rated voltage: 32V (can reach 58V with special material)
 Breaking capacity: 1000A@32V DC
 Operating temperature: -40°C ~ +125°C
 Material; I: zinc alloy II: plastic
 Standards: SAE J2077, JASO, D612, ISO 8820-3, QC/T 420

Blowing characteristic

I _r %	blowing time	
	minimum	maximum
110%	100h	---
135%	0.75s	1,800s
200%	0.15s	5s
350%	0.04s	0.5s
600%	0.02s	0.1s

Specification

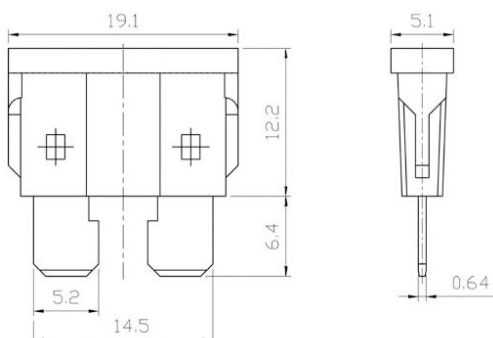

Part No.	I _r (A)	Shell color
ATS 1	1 A	
ATS 2	2 A	
ATS 3	3 A	
ATS 4	4 A	
ATS 5	5 A	
ATS 7.5	7.5 A	
ATS 10	10 A	
ATS 15	15 A	
ATS 20	20 A	
ATS 25	25 A	
ATS 30	30 A	
ATS 35	35 A	
ATS 40	40 A	



Voltage Rating: 32 VDC
 Interrupting Rating: 1000A @ 32 VDC
 Operating Temperature Range: -40°C to +105°C
 Terminals: Sn plated zinc alloy
 Housing Material: PA66
 Complies with: ISO 8820-3
 UL 248 Special Purpose Fus



Time-Current Characteristic

I _r %	Opening Time Min / Max (s)
110	360,000 s /
135	0.75 s / 600 s
200	0.15 s / 5 s
350	0.080 s / 0.250 s
600	0.030 s / 0.100 s

Rating

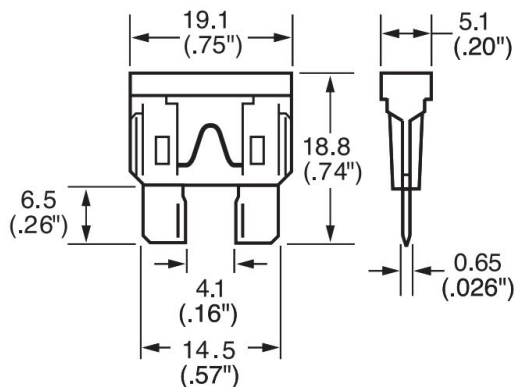

Par No.	I _r (A)	Shell color
257001	1 A	
257002	2 A	
257003	3 A	
257004	4 A	
257005	5 A	
257075	7.5 A	
	10 A	
	15 A	
	20 A	
	25 A	
	30 A	
	35 A	
	40 A	



大型插片保险丝
maxi blade fuse

汽车保险丝
AUTO Fuse



Rated voltage: 32V (can reach 58V with special material)
 Breaking capacity: 1000A@32V DC
 Operating temperature: -40°C~+125°C
 Material: I: zinc alloy II: plastic
 Standards: SAE J2077, JASO, D612, ISO 8820-3, QC/T 420

Blowing characteristic

Ir%	Blowing time	
	minimum	maximum
100%	100h	---
135%	60s	1,800s
200%	2s	60s
350%	0.2s	7s
600%	0.04s	1s

Specification

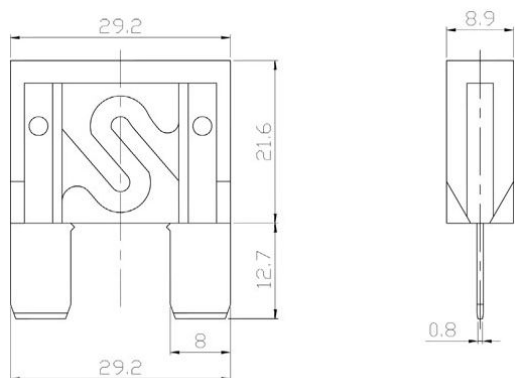

Part No.	Ir(A)	Shell color
ATM 20	20 A	Yellow
ATM 30	30 A	Green
ATM 40	40 A	Orange
ATM 50	50 A	Red
ATM 60	60 A	Blue
ATM70	70 A	Brown
ATM 80	80 A	
ATM 100	100 A	

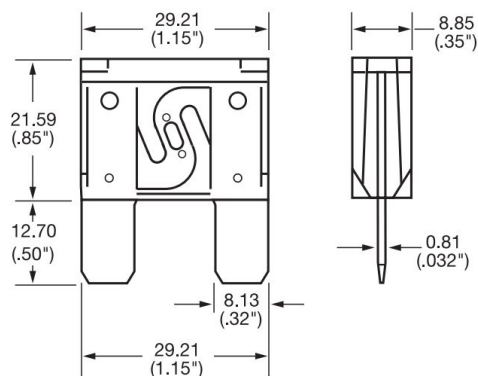
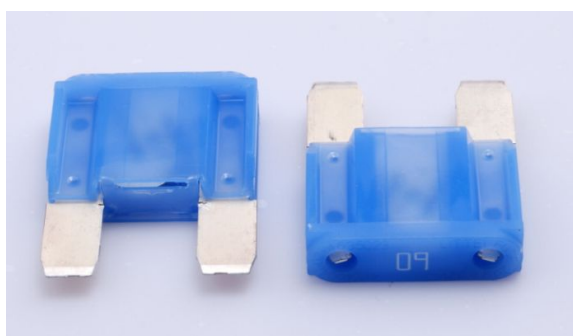

Time-Current Characteristic

Ir%	Opening Time Min / Max (s)
110	360,000 s /
135	60 s / 600 s
200	2 s / 60 s
350	0.2 s / 7s
600	0.040 s / 1 s

Specification

Part No.	Ir(A)	Shell color
0299020	20 A	Yellow
0299025	25 A	Grey
0299030	30 A	Green
0299035	35 A	Brown
0299040	40 A	Orange
0299050	50 A	Red
0299060	60 A	Blue
0299070	70 A	Brown
0299080	80 A	



小叉栓保险丝
mini bolt-on fuse

汽车保险丝 AUTO Fuse

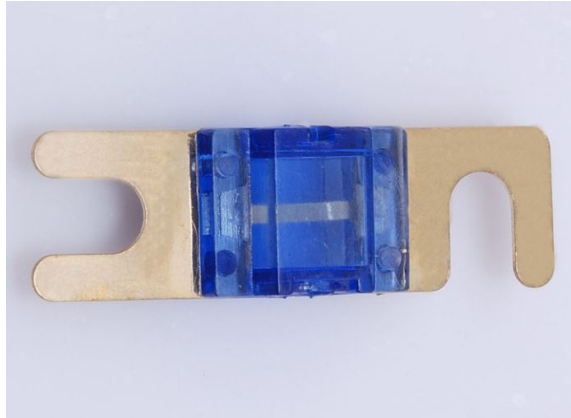

fast blowing fuse

Ur: 32V

Standards: SAE J554

Material: 1、copper alloy(gold plated) 2、zinc alloy
3、PC plastic

Blowing characteristics

Ir%	Blowing time	
	minimum	maximum
100%	100h	---
110%	4h	---
150%	90s	3600s
200%	5s	100s
350%	0.5s	15s

保险丝目录

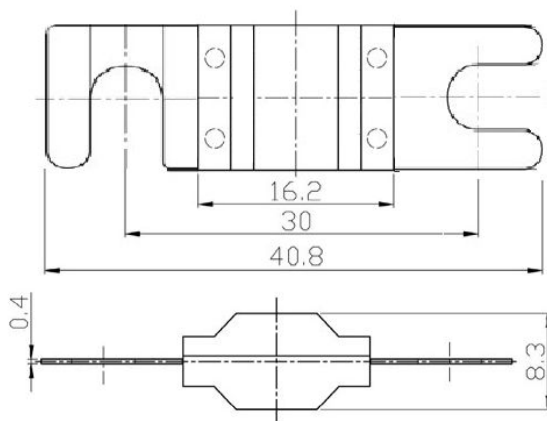

Part No.	Ir(A)	Shell color
ANS 30	30 A	Yellow
ANS 40	40 A	Green
ANS 50	50 A	Orange
ANS 60	60 A	Red
ANS70	70 A	Cyan
ANS 80	80 A	Brown
ANS100	100 A	
ANS125	125 A	
ANS150	150 A	

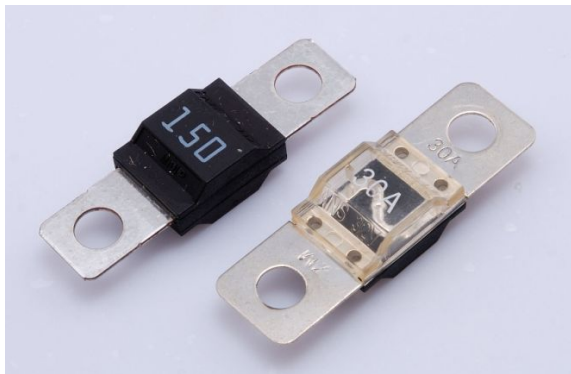

Interrupting Rating: 1000A @ 32 VDC
Voltage Rating: 32 VDC
Operating Temperature Range: - 40°C to + 125°C
Housing: Out of thermoplastic
Terminal: Tin plated Copper
Mounting Torque M5: 4.5 Nm +/- 1Nm
Mounting Torque M6: 5.5-6.5 Nm +/- 1Nm (Except 23A)
Complies with: ISO 8820-5
UL 248 Special Purpose Fuse

Time-Current Characteristic

Ir %	Opening Time Min / Max (s)
110	360,000 s /
135	60 s / 600 s
200	2 s / 60 s
350	0.2 s / 7s
600	0.040 s / 1 s

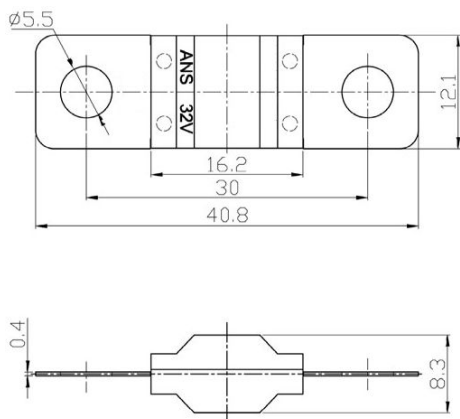

Rating

Part No.	Ir(A)	Shell color
498023	23 A	
498030	30 A	Orange
498040	40 A	Green
498050	50 A	Red
498060	60 A	Yellow
498070	70 A	Brown
498080	80 A	
498100	100 A	Cyan
498125	125 A	Pink
498150	150 A	Grey
498175	175 A	Dark Grey
498200	200 A	Purple



管状保险丝
glass tube fuse

汽车保险丝
AUTO Fuse



fast blowing fuse

Ur: 32V

Standards: SAE J554

Material: 1. copper alloy 2. zinc alloy
3. glass tube

Blowing characteristic

Ir%	blowing time	
	minimum	maximum
110%	4 hrs.	---
135%	---	1 hr.
200%	---	5 s.

保险丝目录

Part No.	Ir(A)
AGC-1	1A
AGC-2A	2 A
AGC-3	3 A
AGC-4	4A
AGC-5	5A
AGC-6	6A
AGC-7	7A
AGC-8	8A
AGC-10	10A
AGC-15	15A
AGC-20	20A
AGC-25	25A
AGC-30	30A

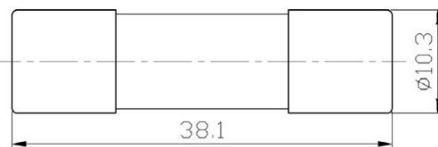

fast blowing fuse

Ur: 32V

Standards: SAE J554

Material: 1. copper alloy(gold plated) 2. zinc alloy
3. glass tube

Blowing Characteristic

Ir%	Blowing time		
	---	minimum	maximum
100%	35A ~ 80A	4 hrs.	---
110%	10A ~ 30A	4 hrs.	---
135%	10A ~ 30A	---	1 hr.
200%	10A ~ 30A	---	5 s
300%	35A ~ 80A	---	4 s

Rating

Part No.	Ir(A)
AGU-G 10	10 A
AGU-G 15	15 A
AGU-G 20	20 A
AGU-G 25	25 A
AGU-G 30	30 A
AGU-G 35	35 A
AGU-G 40	40 A
AGU-G 50	50 A
AGU-G 60	60 A
AGU-G 70	70 A
AGU-G 80	80 A



大叉栓保险丝
maxi bolt-on fuse

汽车保险丝
AUTO Fuse



Ur: 32V (can reach 80V using special material)
Standards: DIN 43560/1
Material: 1. copper alloy 2. plastic

熔断特性

Ir%	Blowing time	
	minimum	maximum
110%	100h	---
135%	0.75s	1,800s
200%	0.15s	5s
350%	0.04s	0.5s
600%	0.02s	0.1s

保险丝目录

Part No.	Ir(A)
ANL 40	40A
ANL 50	50A
ANL 60	60A
ANL 70	70A
ANL 80	80A
ANL 100	100A
ANL 125	125A
ANL150	150A
ANL 175	175A
ANL 200	200A
AML225	225A
ANL250	250A
ANL275	275A
ANL300	300A
ANL350	350A
ANL400	400A

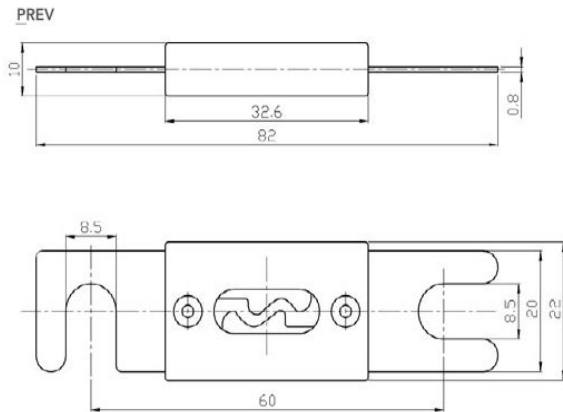

Interrupting Rating: 2000A @ 32 VDC
Voltage Rating: 32 VDC
Operating Temperature Range: -40°C to + 125°C
Housing: PPA (33%/35% GF)
Terminals: Copper (Silver plated copper available) M6 or M8 bolts available
Mounting Torque: 8-14 Nm M6 12-18 Nm M8
Complies with: ISO 8820-

Time-Current

Characteristic

Ir%	Opening Time Min / Max (s)
110	360,000 s /
135	0.75 s / 600 s
200	0.15 s / 5 s
350	0.080 s / 0.250 s
600	0.030 s / 0.100 s

Rating

Part No.	Ir(A)
298040	40A
298050	50A
298060	60A
298070	70A
298080	80A
298100	100A
298125	125A
298150	150A
298175	175A
298200	200A
298225	225A
298250	250A
298300	300A
298350	350A

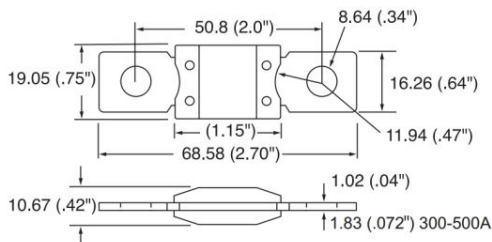



线束安装系列

汽车保险丝座 In-line AUTO Fuse Holder

编号: SL709A

电流:10A 电压:AC250V

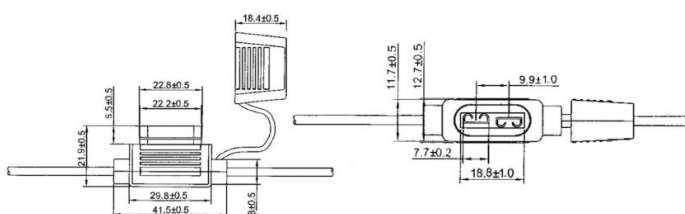

编号: SL709B

电流:6.3A 电压:AC250V

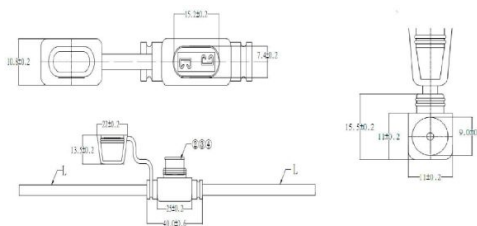

编号: SL709CA

电流:10A 电压:AC250V

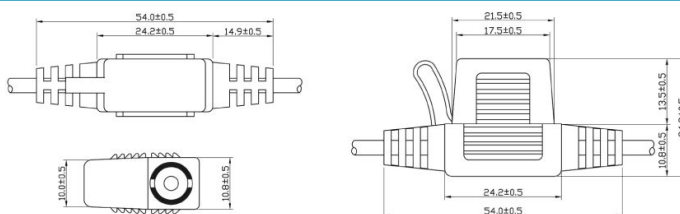

编号: SL708A

电流:6.3A 电压:AC250V

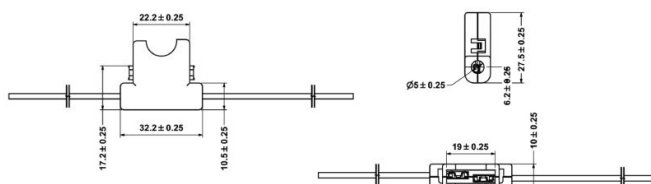

编号: SL708B

电流:6.3A 电压:AC250V

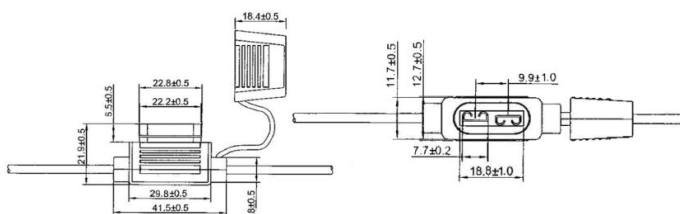

编号: SL708C

电流:6.3A 电压:AC250V

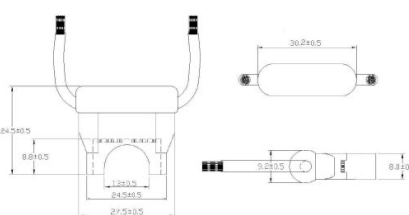



线束安装系列

汽车保险丝座
In-line AUTO Fuse Holder

编号: SL 708D

电流:10A 电压:AC250V

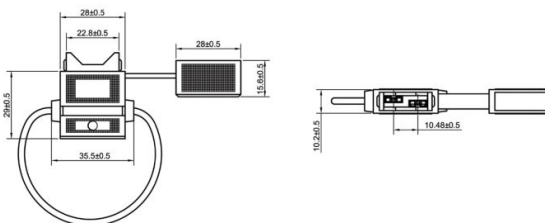
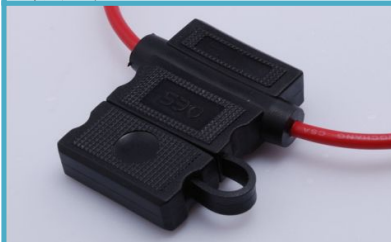

编号: SL708E

电流:6.3A 电压:AC250V

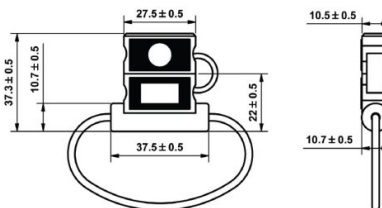

编号: SL703

电流:10A 电压:AC250V

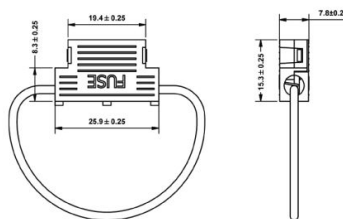
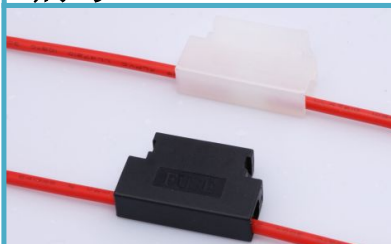

编号: SL707

电流:6.3A 电压:AC250V

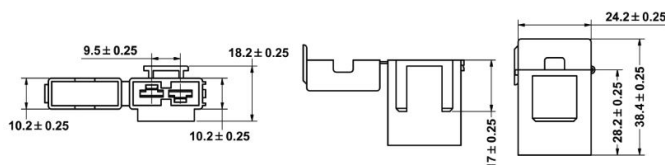

编号: SL709L

电流:6.3A 电压:AC250V

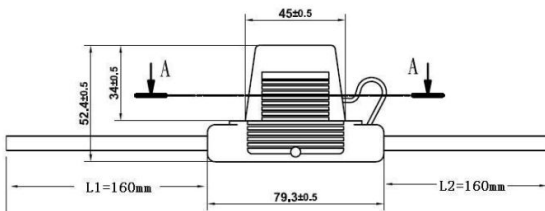

编号: SL709L

电流:6.3A 电压:AC250V

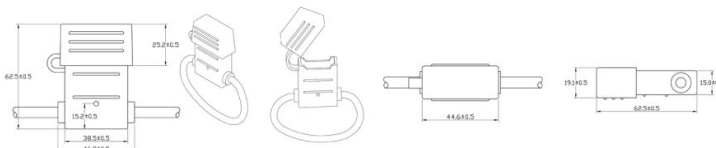



PCB机箱安装系列

汽车保险丝座

PCB Box AUTO Fuse Holder

编号: SL703E

电流:10A 电压:AC250V

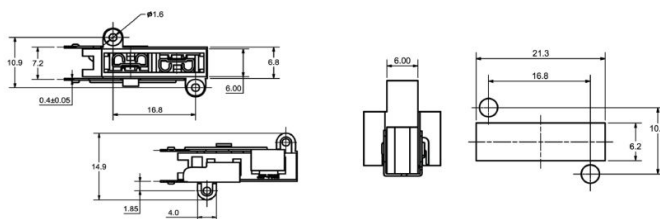

编号: SL703C

电流:6.3A 电压:AC250V

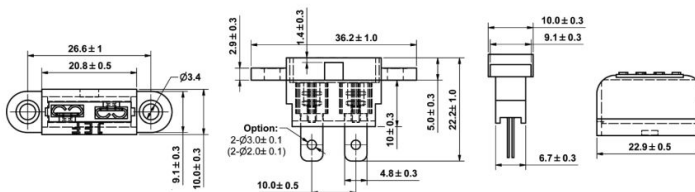

编号: SL703D

电流:10A 电压:AC250V

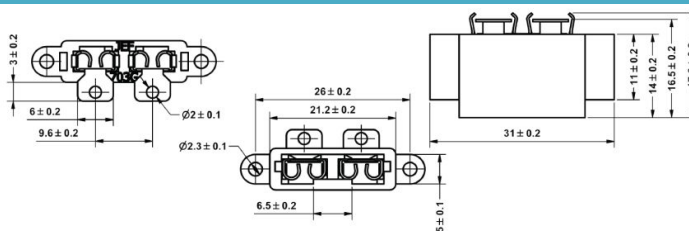

编号: SL703 FA

电流:6.3A 电压:AC250V

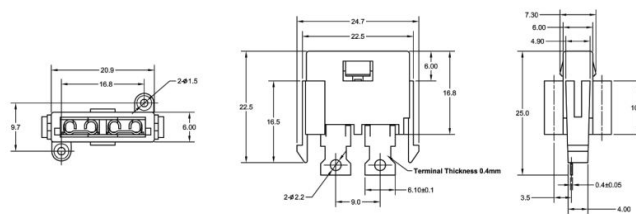

编号: SL703FC

电流:6.3A 电压:AC250V

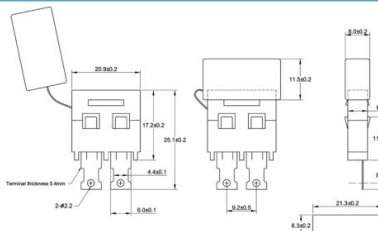

编号: SL703H

电流:6.3A 电压:AC250V

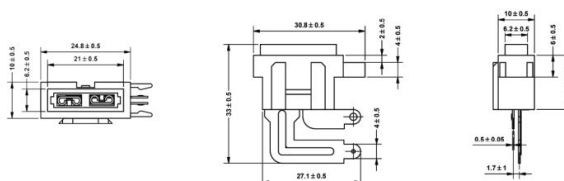



编号: SL506K

电流:10A 电压:AC250V

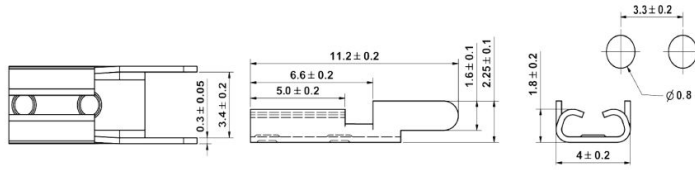

编号: SL506P

电流:6.3A 电压:AC250V

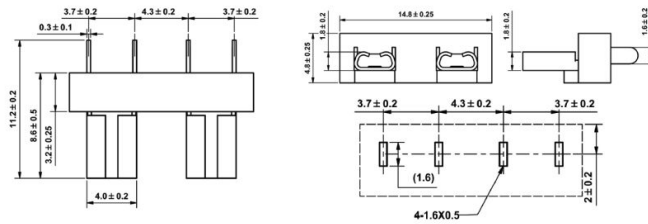
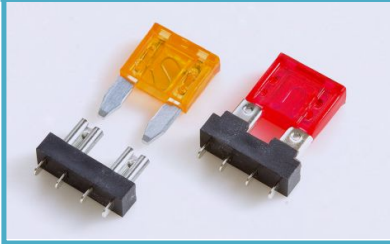

编号: SL506H

电流:10A 电压:AC250V

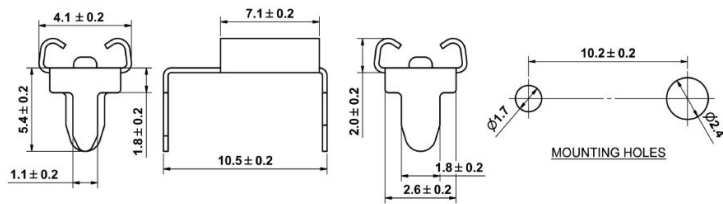
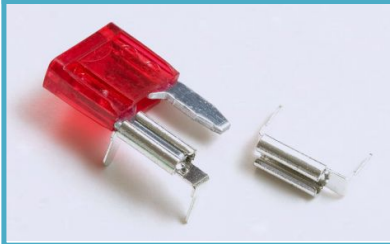

编号: SL506BA

电流:6.3A 电压:AC250V

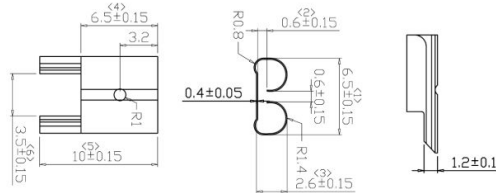

编号: SL506J

电流:6.3A 电压:AC250V

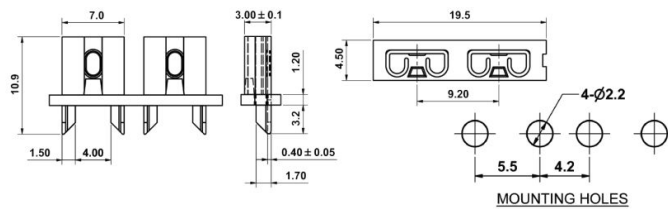
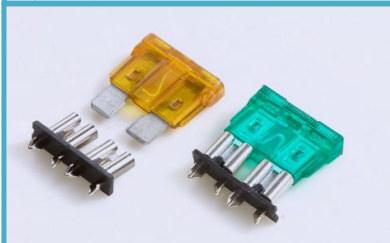

编号: SL506Q

电流:6.3A 电压:AC250V

