

APPROVAL SHEET

Customer:	
Description:	MEMS Microphone
Model:	CMM3722AT-110H62S383
Customer P/N:	

Issued by	Checked by	Appoved by	Customer

HUNSTON ELECTRONICS LIMITED

Website: hunston.com.hk
Email: sales@hunston.com.hk
Tel: +852 3591 1490
Fax: +852 3591 1491

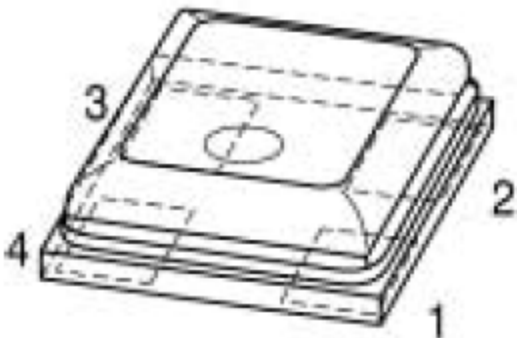
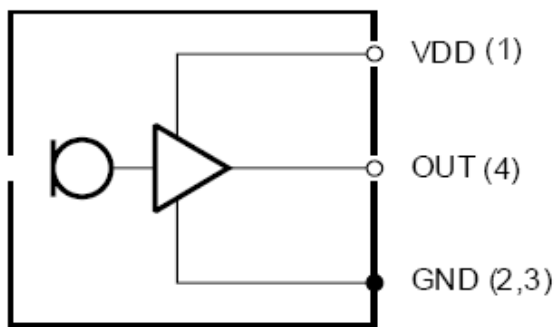
1	Name: Silicon MEMS Omni-directional Microphone	
2	Features:	
	3.1	SMD MEMS microphone for automated surface mount assembly
	3.2	Reflow soldering up to 260°C (Lead free)
	3.3	High long-term temperature stability
	3.4	Stable sensitivity over power supply range of 1.5~3.6V
	3.5	Low current consumption of 80uA
	3.6	Excellent power supply rejection of -55dB
	3.7	High integrated immunity to EMI
	3.8	RoHS-compliant, halogen-free package with small footprint and low height of 1.25mm
3	Applications. The CMM3722AT-110H62S383 is designed for:	
	4.1	Mobile Phones (Handsets, Headsets)
	4.2	Consumer (Game Consoles, PDA's)
	4.3	Computer (Personal Computers, Notebooks)
	4.4	Cameras (Digital Still Cameras, Video Cameras)
	4.5	Navigation Device(Portable GPS)
	4.6	Blue-tooth (Headsets)
4	Product Description	
	<p>Miniature Silicon MEMS (Micro Electro Mechanical System) Omni-directional Microphone with single-ended analog interface designed for automated reflow soldering assembly as SMD (Surface Mounted Device) component. It is an alternative to conventional ECMs (Electret Condenser Microphones).</p> <p>Due to its robust design with a metallic lid and monolithic integrated EMI-blocking capacitors and utilization of Silicon MEMS technology, the CMM3722AT-110H62S383 shows high immunity to EMI (Electromagnetic Interference) and heat.</p> <p>The capped Chip-On-Board package solution contains the micromechanical sensor chip and an amplifier chip. The RoHS-compliant halogen-free device has a size of 3.76 x 2.24 x 1.10 mm³.</p>	
5	Circuit Diagram:	
	 	

Pin Definition and Function						
Pin No.	Symbol	Function				
1	V _{DD}	Power				
2	GND	Ground				
3	GND	Ground				
4	OUT	Output				
Maximum Ratings						
Storage Temperature	T _{STG}	-40°C ~ 140 °C				
Operating Temperature Range	T _A	-40°C ~ 125°C				
Operating Voltage Range	V _{DD}	1.5 V~ 3.6 V				
Typical robustness to electrostatic discharge						
ESD capability all pins (HBM, JESD22-A114)		V _{ESD_HBM}	± 2 kV			
ESD capability all pins (MM, JESD22-A115)		V _{ESD_MM}	± 500 V			
6	Acoustical and Electrical Characteristics					
Unless otherwise noted, typical test conditions are T _A = 23 °C, V _{DD} = 2.0 V and R.H. = 50 % measured in a pressure chamber test setup. All voltages refer to GND node						
Parameter	Symbol	Values			Unit	Note / Test Condition
		Min.	Typ.	Max.		
Sensitivity 1 kHz	S _{1kHz}	-41	-38	-35	dB(V/Pa)	1 kHz, 94 dB SPL
Relative Sensitivity 4 kHz	⊗S _{4kHz}	-1		+4	dB	Relative to sensitivity 1 kHz
Relative Sensitivity 240 Hz	⊗S _{240Hz}	-1		+1	dB	Relative to sensitivity 1 kHz
Acoustic Overload Point	AOP		10		%	130 dB SPL @1 kHz
Signal-to-Noise Ratio			62		dB(A)	94dB SPL @ 1kHz A-weighted
Total Harmonic Distortion	THD		1		%	94 dB SPL, 1 kHz
Current Consumption	I _{dd}		80	120	u A	V _{DD} = 2.0 V
Power Supply Rejection Ratio	PSRR		-56		dBr	F=217Hz 0.1Vpp sine wave
DC Output Voltage	V _{OUT}		0.9		V	DC Voltage at Pin 4
Output Impedance	Z _{OUT}		150	300	Ω	1 kHz
1) Psophometrically weighted noise measurement with CCITT-filter (ITU-T Rec. P.53)						
2) Noise measurement with A-weighting filter (IEC 651)						

7 Schematic Measuring Diagram:

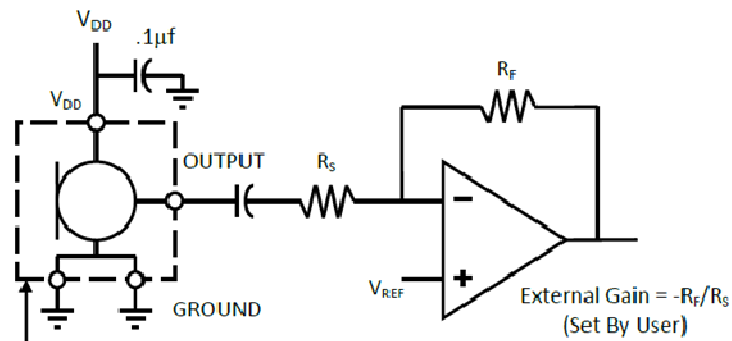

8 Typical Measurements Results:

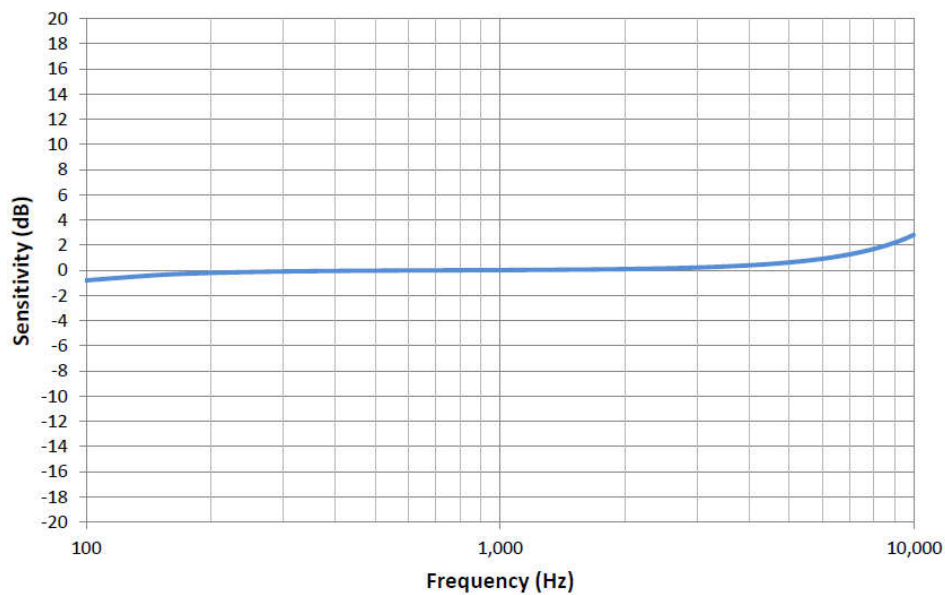

Typical frequency response curve relative to the sensitivity at a frequency of 1 kHz

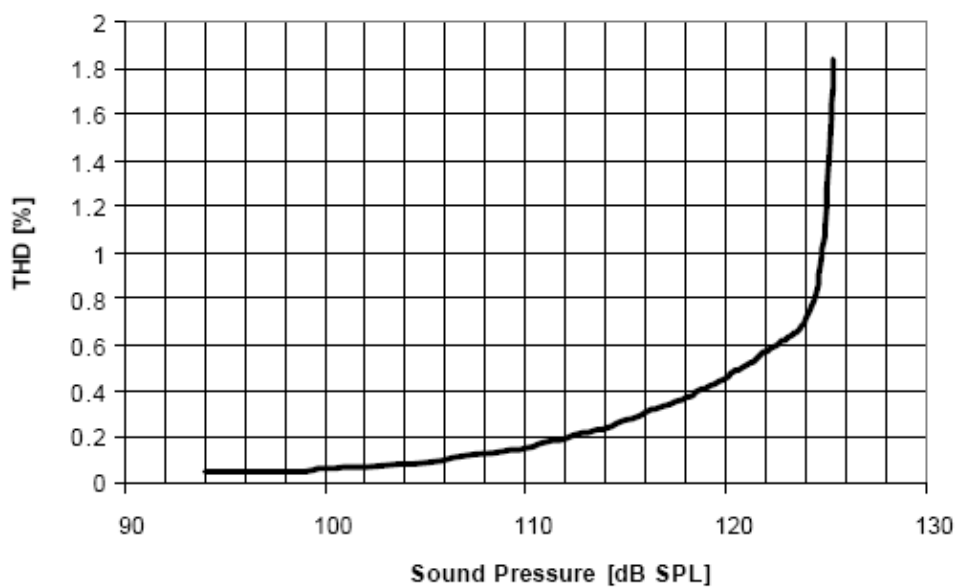

9	RELIABILITY SPECIFICATIONS	
	Note: After test conditions are performed, the sensitivity of the microphone shall not deviate more than 3dB from its initial value	
	Test	Description
	Thermal Shock	Microphone unit must operate when exposed to air-to-air thermal shock 100 cycles, from -40°C to $+125^{\circ}\text{C}$. (IEC 68-2-4),
	High Temperature Storage Test	Microphone unit must maintain sensitivity after storage at $+105^{\circ}\text{C}$ for 1,000 hours. (IEC 68-2-2 Test Ba)
	Low Temperature Storage Test	Microphone unit must maintain sensitivity after storage at -40°C for 1,000 hours. (IEC 68-2-1 Test Aa)
	High Temperature Operating Test	Microphone unit must operate within sensitivity specifications for 1,000 hours at 105°C . (IEC 68-2-2 Test Ba)
	Low Temperature Operating Test	Microphone unit must operate within sensitivity specifications for 1,000 hours at -40°C . (IEC 68-2-1 Test Aa)
	Humidity Test	Tested under Bias at $85^{\circ}\text{C}/85\%$ R.H. for 1,000 hours. (JESD22-A101A-B)
	Vibration Test	Microphone unit must operate under test condition: 4 cycles, from 20 to 2,000 Hz in each direction (x,y,z), 48 minutes, using peak acceleration of 20 G (+20%, -0%). (MIL 883E, method 2007.2, A)
	Electrostatic Discharge	Tested to 2kV direct contact discharge or 8kV air discharge as specified by IEC 1000-4-2, level 3 and level 4.
	Reflow	Microphone is tested to 5 passes through reflow oven, with microphone mounted upside-down under conditions of 260°C for 30 seconds maximum.
	Mechanical Shock	Microphone must operate after exposure to shock test of 10,000 G per IEC 68-2-27, Ea.
10	Notes:	
	<ol style="list-style-type: none"> 1. Do not pull a vacuum over the port hole of the microphone. Pulling a vacuum over the port hole can damage the device. 2. Do not board wash after the reflow process. Board washing and cleaning agents can damage the device. Do not expose to ultrasonic processing or cleaning. 3. Number of Reflow = recommend no more than 3 cycles. 4. elf life: Twelve (12) months when devices are to be stored in factory supplied, unopened ESD moisture sensitive bag under maximum environmental conditions of 30°C, 70% R.H. 5. exposure: Devices should not be exposed to high humidity, high temperature environment. MSL (moisture sensitivity level) Class 2A. 6. out of bag: Maximum of 90 days out of ESD moisture sensitive bag, assuming maximum conditions of $30^{\circ}\text{C}/70\%$ R.H. 	

11 Solder Reflow Profile

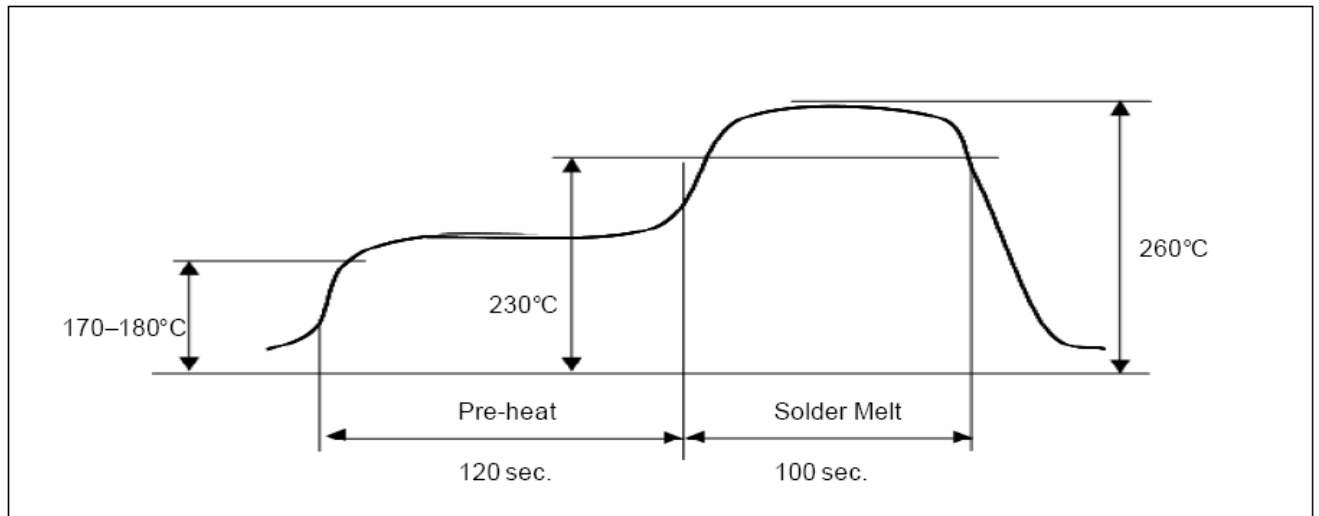

<i>Stage</i>	<i>Temperature Profile</i>	<i>Time (maximum)</i>
Pre-heat	170 ~ 180 C	120 sec.
Solder Melt	Above 230 C	100 sec.
Peak	260 C maximum	30 sec.

12 Package Outline

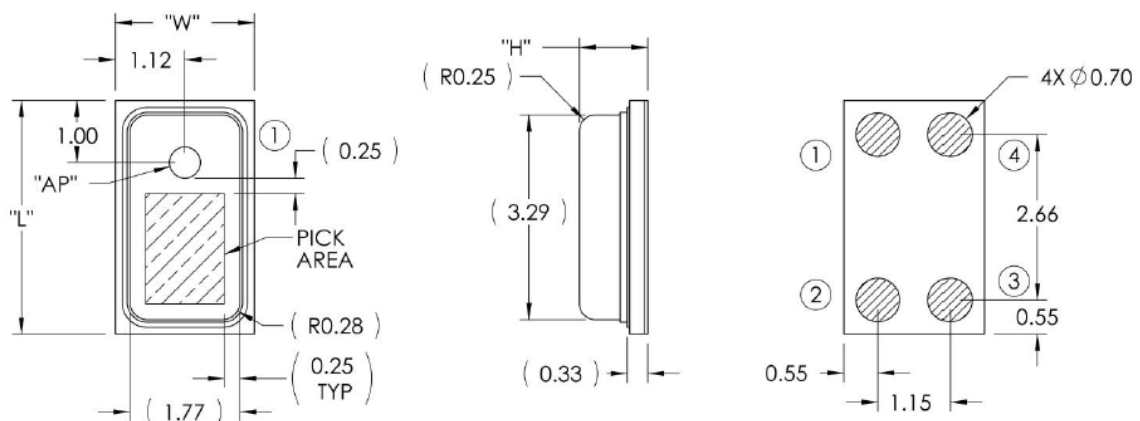

Please don't vacuum over the acoustic port directly. The recommendation is for reference.

Item	Dimension	Tolerance
Length (L)	3.76	±0.10
Width (W)	2.24	±0.10
Height (H)	1.10	±0.10
Acoustic Port (AP)	∅0.50	±0.05

Pin #	Pin Name	Type	Description
1	V _{DD}	Power	Power Supply
2	GROUND	Power	Ground
3	GROUND	Power	Ground
4	OUTPUT	Signal	Output Signal

Notes: Pick Area only extends to 0.25 mm of any edge or hole unless otherwise specified.

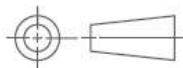

Dimensions are in millimeters unless otherwise specified.

Tolerance is ±0.15mm unless otherwise specified

13 Recommended Customer Land Pattern

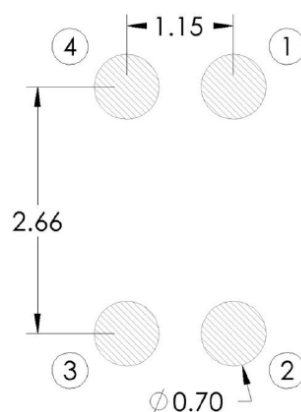

14 Tape Outline

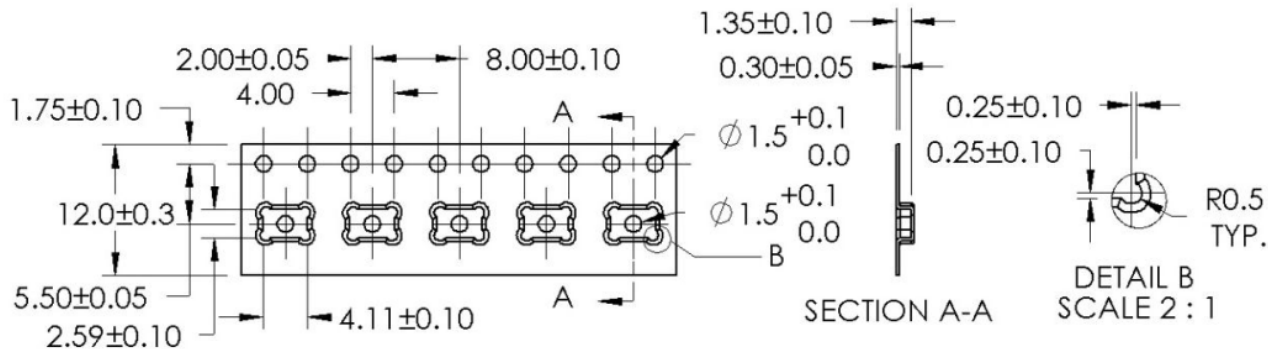

Notes: Dimensions are in millimeters unless otherwise specified.
 Vacuum pickup only in the pick area indicated in Mechanical Specifications.
 Tape & reel per EIA-481.
 Labels applied directly to reel and external package.
 Shelf life: Twelve (12) months when devices are to be stored in factory supplied, unopened ESD moisture sensitive bag under maximum environmental conditions of 30°C, 70% R.H.

15 Reel Outline

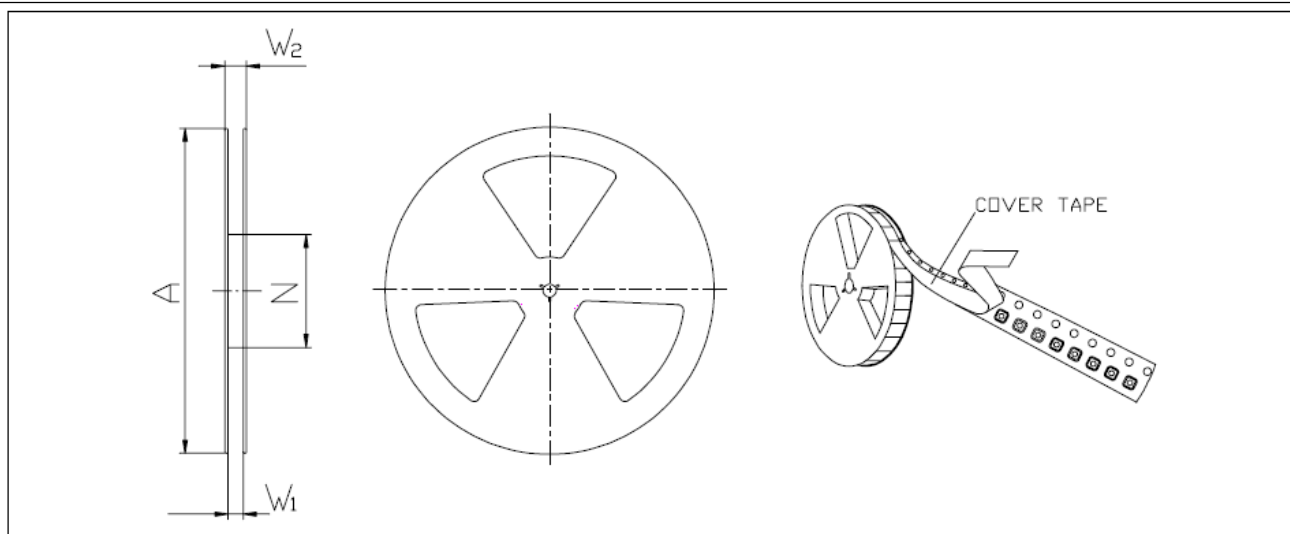

Reel Dimension (mm) and Quantity per Reel

A	W ₁	W ₂	N	Quantity per Reel
Ø 330	12.4±1.5	18.4 MAX	Ø 100	5000