

Electret Condenser Microphone (Omnidirectional)

Model: CMOB6015-2022-423P-1033



ELECTRICAL SPECIFICATIONS

	Condition	Parameter	Unit
Directivity		Omnidirectional	
Sensitivity	0dB = 1V/Pa, 1KHz	-42 ± 3	dB
Operating Voltage		1 ~ 10	Vdc
Standard Operating Voltage		2	Vdc
Output Impedance	1KHz, 1Pa	2.2K	Ω
Frequency Range		50 ~ 16K	Hz
Current Consumption	at recommended drive circuit	Max. 500	μA
Sensitivity Reduction	at 1.5Vdc	within -3	dB
S/N Ratio	1KHz, 1Pa, A-weighted	Min. 60	dBA
Terminal		Pin	
Operating Temperature		-20 ~ +70	°C
Storage Temperature		-20 ~ +70	°C

FREQUENCY RESPONSE CURVE

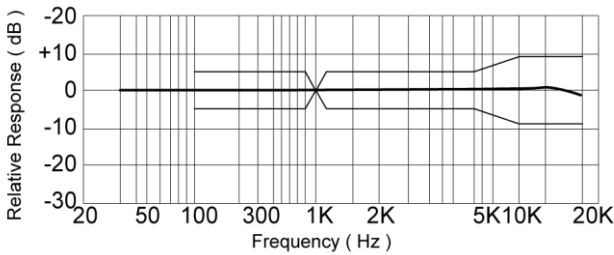

RECOMMENDED DRIVE CIRCUIT

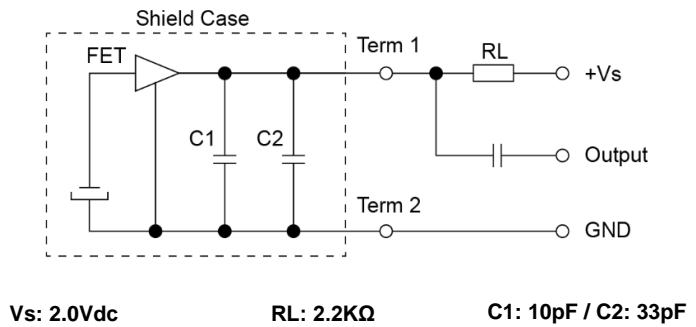

MECHANICAL DRAWING

Dimensions in mm

Tolerance ±0.5mm Except Specified

