

Electret Condenser Microphone (Unidirectional)

Model: CMUB6050-15068-403S-1033



ELECTRICAL SPECIFICATIONS

	Condition	Parameter	Unit
Directivity		Unidirectional	
Sensitivity	0dB = 1V/Pa, 1KHz	-40 ± 3	dB
Operating Voltage		1 ~ 10	Vdc
Standard Operating Voltage		1.5	Vdc
Output Impedance	1KHz, 1Pa	680	Ω
Frequency Range		100 ~ 18K	Hz
Current Consumption	at recommended drive circuit	Max. 500	μA
Sensitivity Reduction	at 1.0Vdc	within -3	dB
S/N Ratio	1KHz, 1Pa, A-weighted	Min. 60	dBA
Terminal		Solder Pads	
Operating Temperature		-20 ~ +70	°C
Storage Temperature		-20 ~ +70	°C

FREQUENCY RESPONSE CURVE

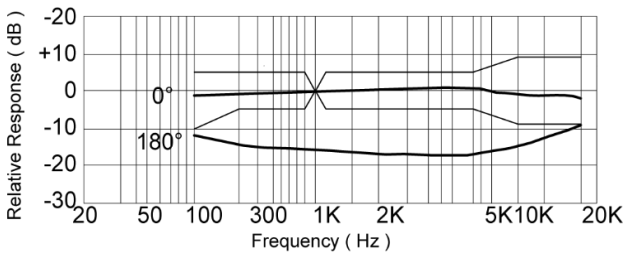

RECOMMENDED DRIVE CIRCUIT

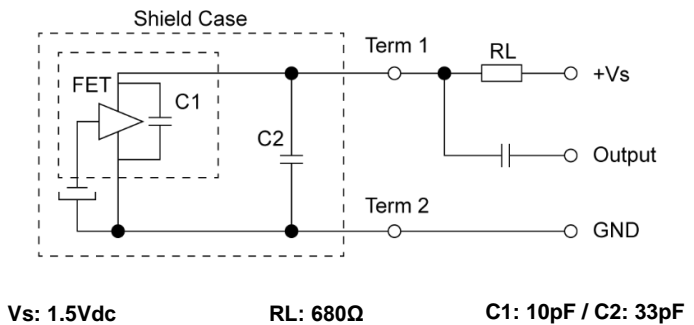

MECHANICAL DRAWING

Dimensions in mm

Tolerance ±0.5mm Except Specified

