

**Loud Speaker (External Magnet)**

**Model: LEU133S-65H25W8N**



**ELECTRICAL SPECIFICATIONS**

	Condition	Parameter	Unit
Sound Pressure Level	at 0.1W, 0.1M [at 0.6, 0.8, 1.0, 1.2KHz]	90 ± 3	dB
Impedance	at 1V, 800Hz	8 ± 15%	Ω
Rated Input Power		25	W
Max Input Power		35	W
Resonant Frequency (Fo)	at 1V	70 ± 20%	Hz
Frequency Range		Fo ~ 10000	Hz
Buzzer & Rattles	not be audible at sine wave between Fo ~ 10KHz	14.14	V
Operating Temperature		-30 ~ 75	°C
Magnet		Ferrite	
Frame Material		Metal	
Cone Material		Paper	
Weight		620	g

**MECHANICAL DRAWING**

Dimensions in mm

Tolerance ±0.5mm Except Specified

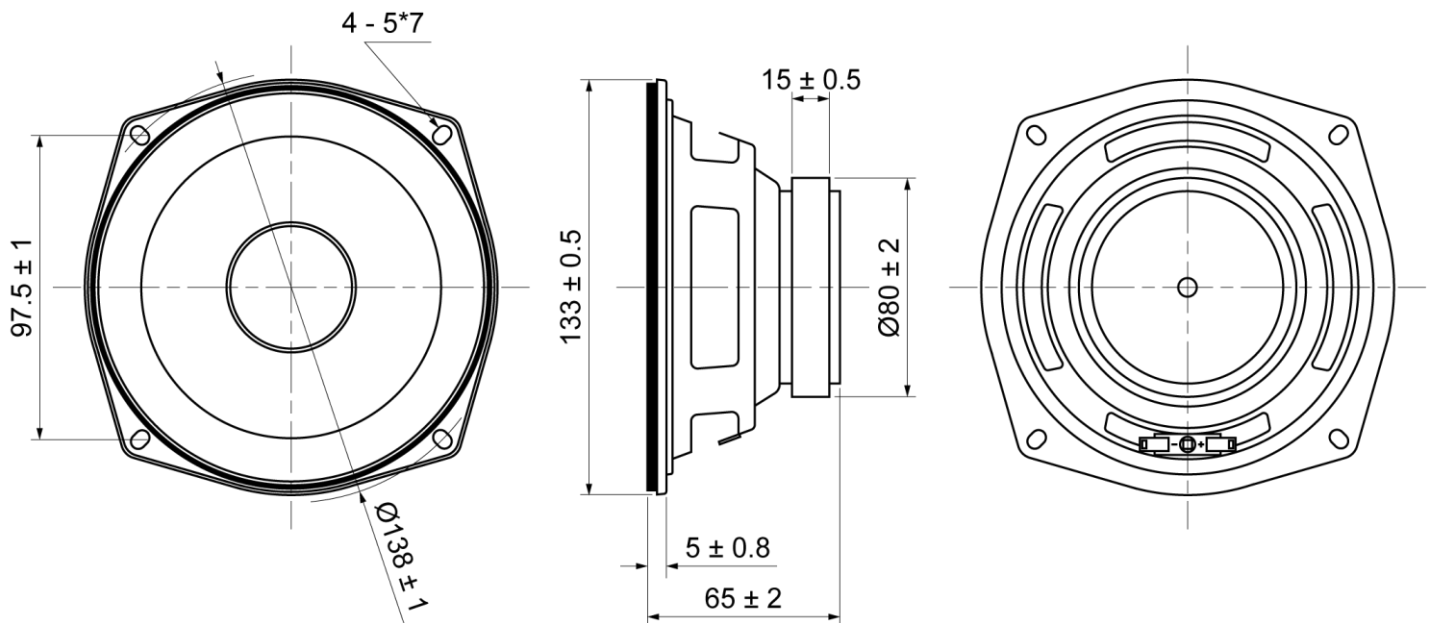

**Loud Speaker (External Magnet)**

Model: LEU133S-65H25W8N

**FREQUENCY RESPONSE CURVE**

