

Loud Speaker (External Magnet)

Model: LEU77S-40H10W4N



ELECTRICAL SPECIFICATIONS

	Condition	Parameter	Unit
Sound Pressure Level	at 1.0W, 1.0M [at 0.6, 0.8, 1.0, 1.2KHz]	92 ± 3	dB
Impedance	at 1V, 800Hz	4 ± 15%	Ω
Rated Input Power		10	W
Max Input Power		15	W
Resonant Frequency (Fo)	at 1V	180 ± 20%	Hz
Frequency Range		Fo ~ 15000	Hz
Buzzer & Rattles	not be audible at sine wave between Fo ~ 15KHz	6.32	V
Operating Temperature		-25 ~ 75	°C
Magnet		Ferrite	
Frame Material		Metal	
Cone Material		Paper	
Weight		230	g

MECHANICAL DRAWING

Dimensions in mm

Tolerance ±0.5mm Except Specified

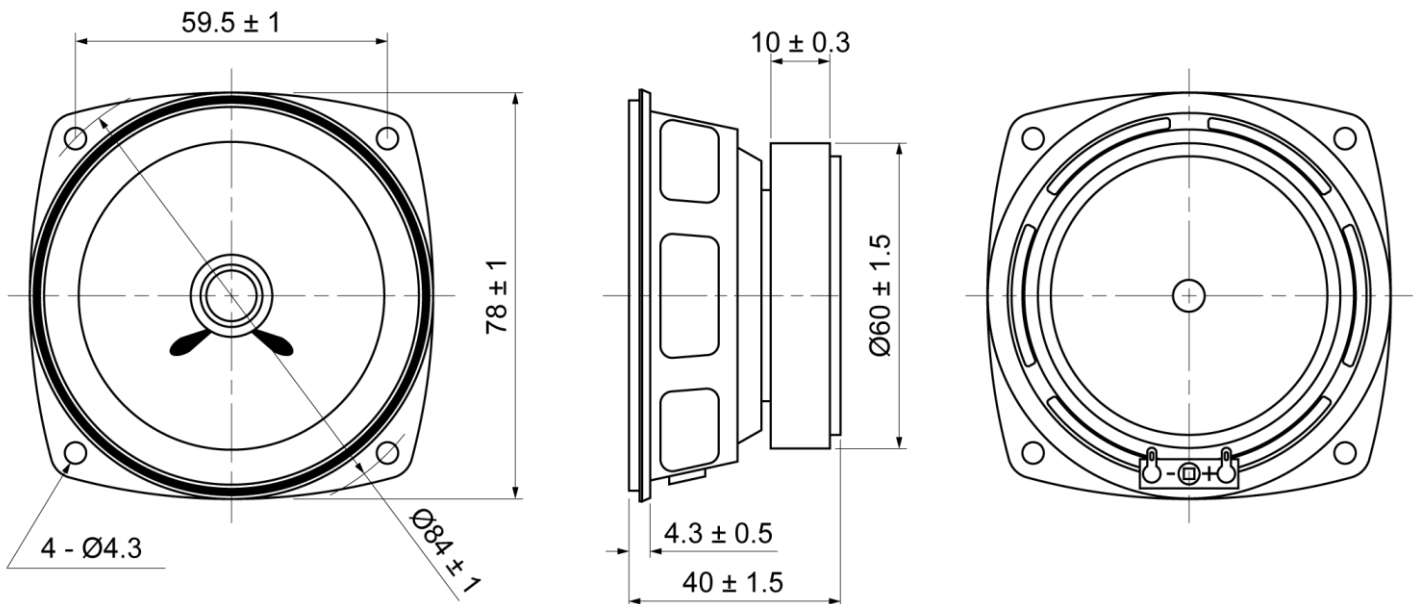

Loud Speaker (External Magnet)

Model: LEU77S-40H10W4N

FREQUENCY RESPONSE CURVE

