

Loud Speaker (Internal Magnet)

Model: LIU45S-28H3.0W4



ELECTRICAL SPECIFICATIONS

	Condition	Parameter	Unit
Sound Pressure Level	at 0.1W, 0.1M [at 1.0, 1.2, 1.5, 2.0KHz]	83 ± 3	dB
Impedance	at 1V, 1000Hz	4 ± 15%	Ω
Rated Input Power		3	W
Max Input Power		5	W
Resonant Frequency (Fo)	at 1V	140 ± 20%	Hz
Frequency Range		Fo ~ 20000	Hz
Buzzer & Rattles	not be audible at sine wave between Fo ~ 20KHz	3.46	V
Operating Temperature		-20 ~ 60	°C
Magnet		Nd-Fe-B	
Frame Material		Metal	
Cone Material		Paper	
Weight		34	g

MECHANICAL DRAWING

Dimensions in mm

Tolerance ±0.5mm Except Specified

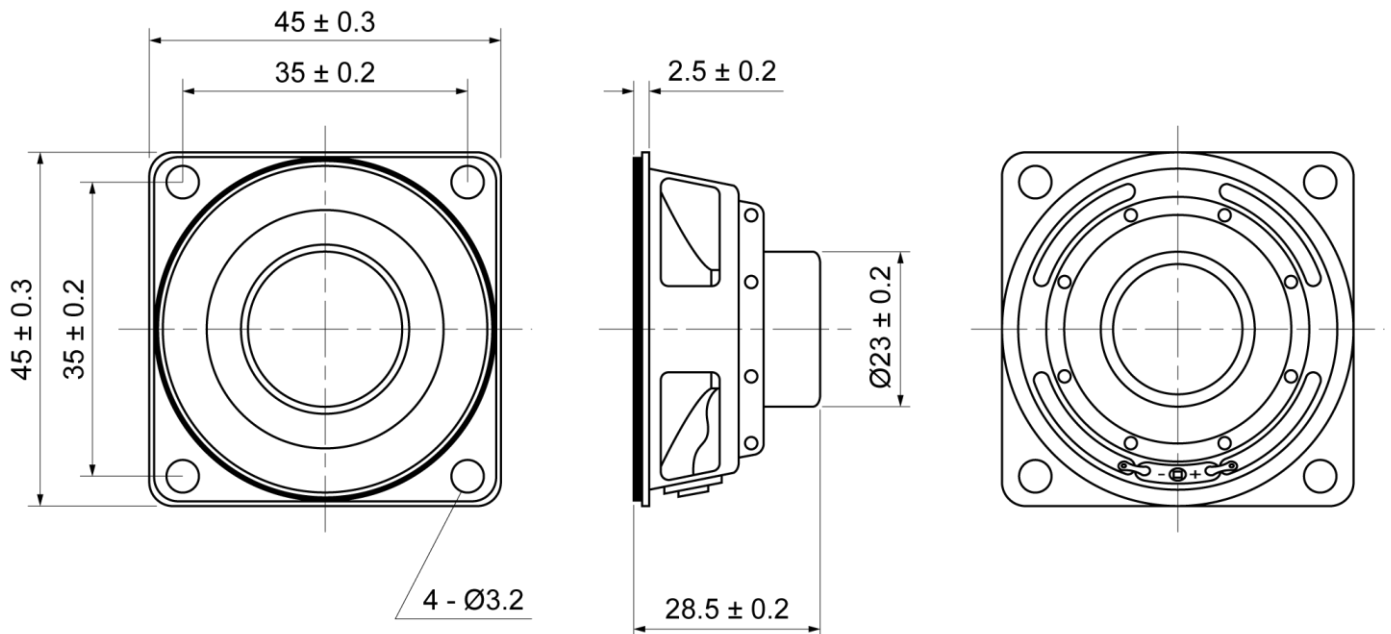

Loud Speaker (Internal Magnet)
Model: LIU45S-28H3.0W4

FREQUENCY RESPONSE CURVE

