

Mylar Speaker (External Magnet)

Model: ME66TR-19H0.3W8N



ELECTRICAL SPECIFICATIONS

	Condition	Parameter	Unit
Sound Pressure Level	at 0.1W, 0.1M [at 0.8, 1.0, 1.2, 1.5 KHz]	91 ± 3	dB
Impedance	at 1V, 1000Hz	8 ± 15%	Ω
Rated Input Power		0.3	W
Max Input Power		0.5	W
Resonant Frequency (Fo)	at 1V	450 ± 20%	Hz
Frequency Range		Fo ~ 20000	Hz
Buzzer & Rattles	not be audible at sine wave between Fo ~ 20KHz	1.54	V
Operating Temperature		-30 ~ 60	°C
Magnet		Ferrite	
Frame Material		Metal	
Cone Material		Mylar (PET)	
Weight		48	g

MECHANICAL DRAWING

Dimensions in mm

Tolerance ±0.5mm Except Specified

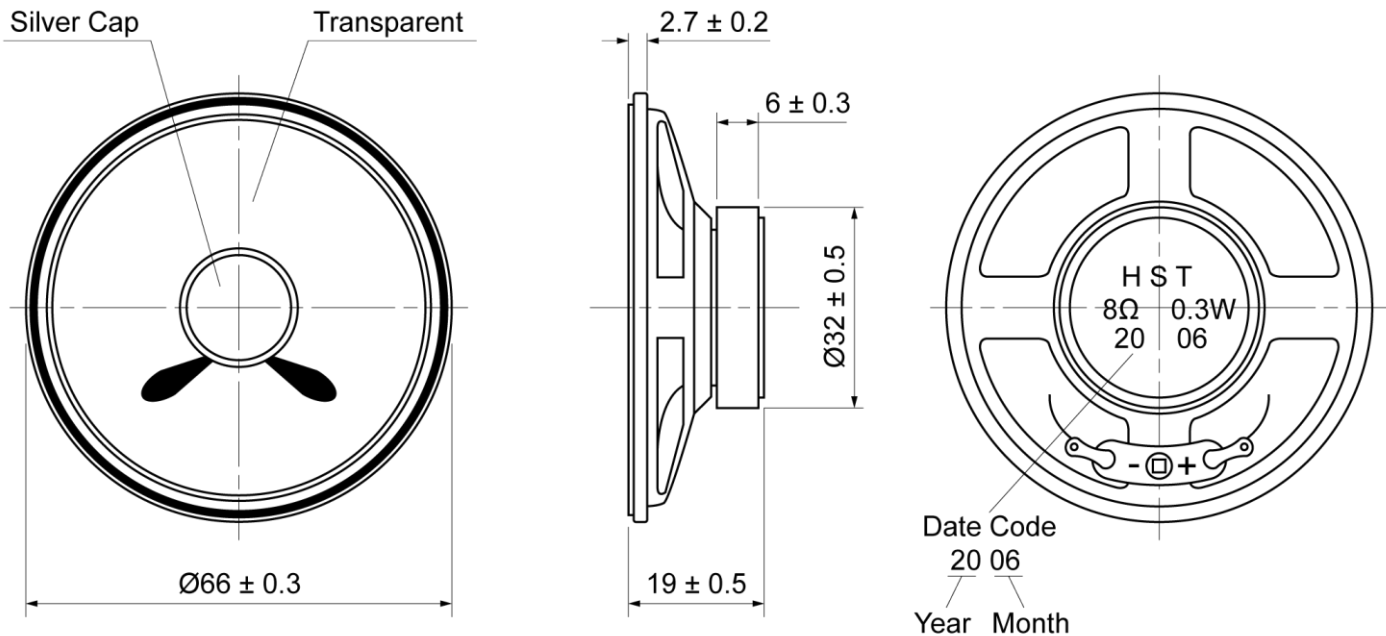

Mylar Speaker (External Magnet)

Model: ME66TR-19H0.3W8N

FREQUENCY RESPONSE CURVE

