

Mylar Speaker (External Magnet)

Model: MEU45R-22H3.0W4N



ELECTRICAL SPECIFICATIONS

	Condition	Parameter	Unit
Sound Pressure Level	at 1.0W, 1.0M [at 0.6, 0.8, 1.0, 1.2KHz]	80 ± 3	dB
Impedance	at 1V, 1000Hz	4 ± 15%	Ω
Rated Input Power		3	W
Max Input Power		5	W
Resonant Frequency (Fo)	at 1V	200 ± 20%	Hz
Frequency Range		Fo ~ 20000	Hz
Buzzer & Rattles	not be audible at sine wave between Fo ~ 20KHz	3.46	V
Operating Temperature		-20 ~ 60	°C
Magnet		Ferrite	
Frame Material		Metal	
Cone Material		Mylar	
Weight		45	g

MECHANICAL DRAWING

Dimensions in mm

Tolerance ±0.5mm Except Specified

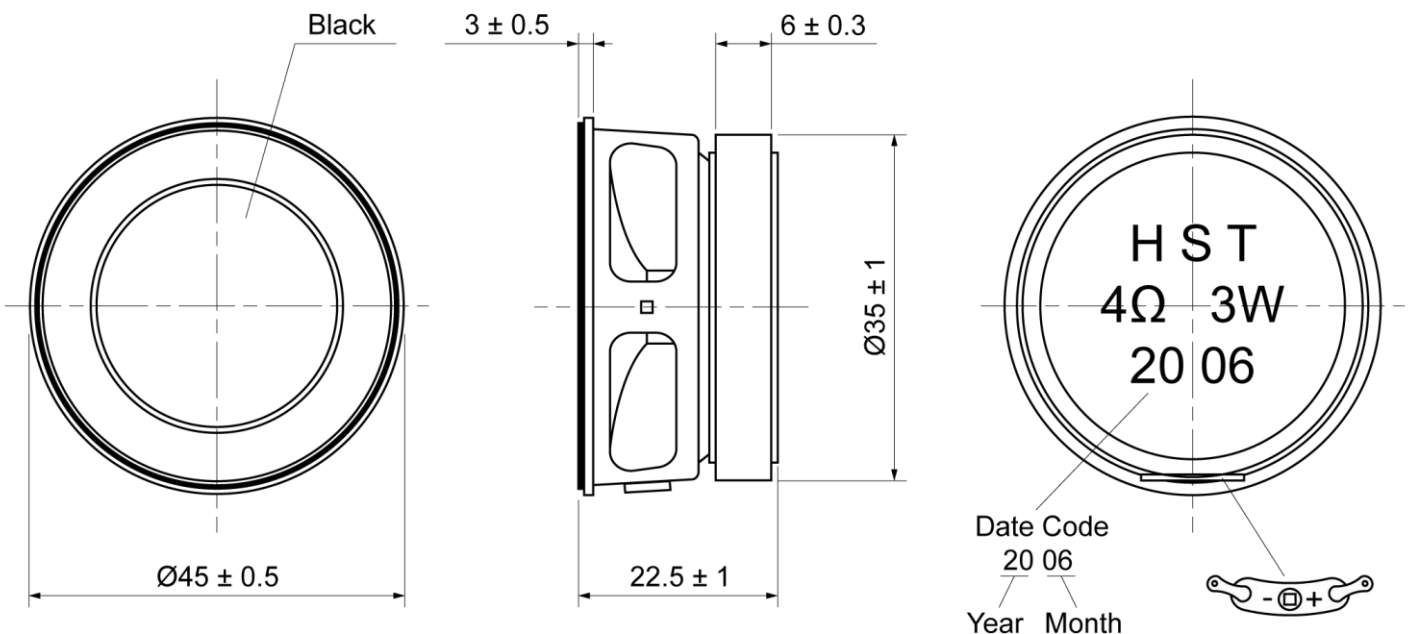

Mylar Speaker (External Magnet)

Model: MEU45R-22H3.0W4N

FREQUENCY RESPONSE CURVE

