

Mylar Speaker (Internal Magnet)

Model: MI4070TE-23H5.0W4



ELECTRICAL SPECIFICATIONS

	Condition	Parameter	Unit
Sound Pressure Level	at 0.1W, 0.1M [at 0.6, 0.8, 1.0, 1.2 KHz]	90 ± 3	dB
Impedance	at 1V, 800Hz	4 ± 15%	Ω
Rated Input Power		5	W
Max Input Power		6	W
Resonant Frequency (Fo)	at 1V	550 ± 20%	Hz
Frequency Range		Fo ~ 15000	Hz
Buzzer & Rattles	not be audible at sine wave between Fo ~ 15KHz	4.47	V
Operating Temperature		-30 ~ 75	°C
Magnet		Nd-Fe-B	
Frame Material		Metal	
Cone Material		Mylar (PET)	
Weight		30	g

MECHANICAL DRAWING

Dimensions in mm

Tolerance ±0.5mm Except Specified

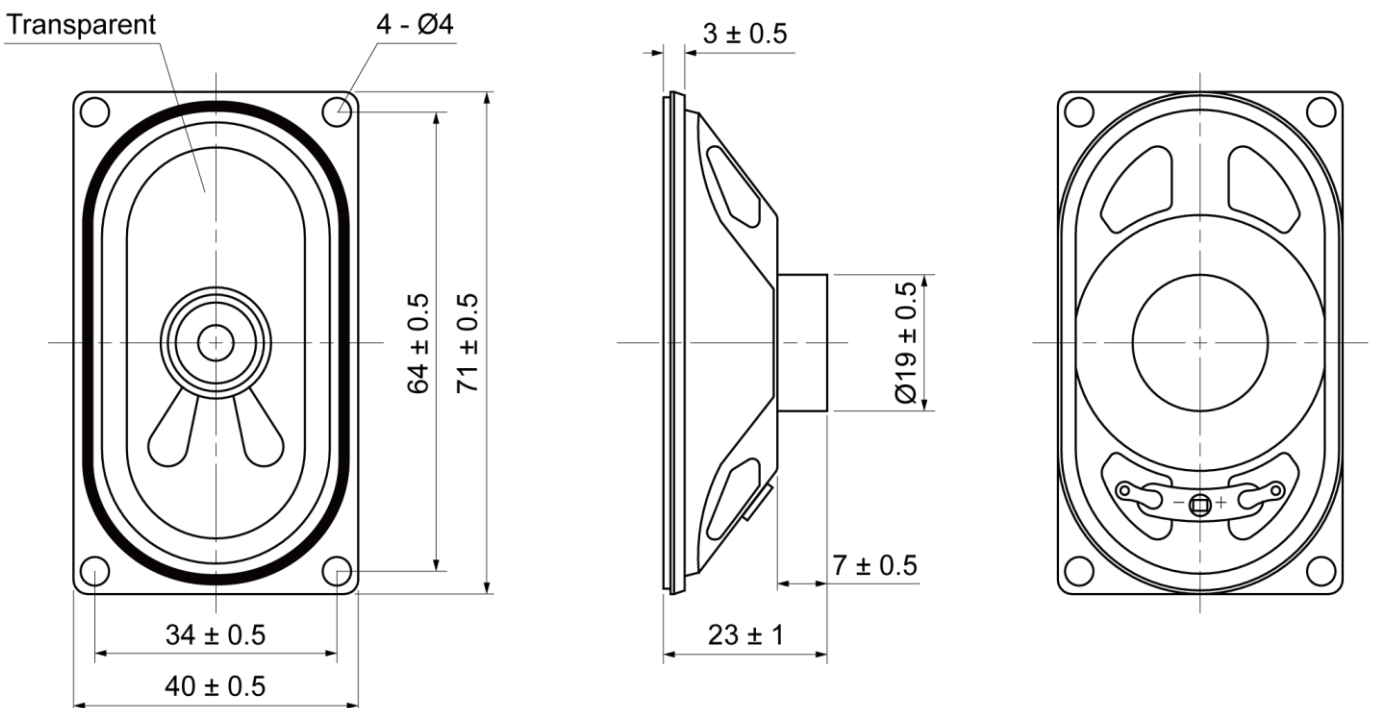

Mylar Speaker (Internal Magnet)

Model: MI4070TE-23H5.0W4

FREQUENCY RESPONSE CURVE

