

**Mylar Speaker (Internal Magnet)**

**Model: MI57TS-14H1.0W8**



**ELECTRICAL SPECIFICATIONS**

	Condition	Parameter	Unit
Sound Pressure Level	at 0.1W, 0.1M [at 0.8, 1.0, 1.2, 1.5 KHz]	91 ± 3	dB
Impedance	at 1V, 800Hz	8 ± 15%	Ω
Rated Input Power		1	W
Max Input Power		2	W
Resonant Frequency (Fo)	at 1V	600 ± 20%	Hz
Frequency Range		Fo ~ 20000	Hz
Buzzer & Rattles	not be audible at sine wave between Fo ~ 20KHz	2.82	V
Operating Temperature		-20 ~ 60	°C
Magnet		Nd-Fe-B	
Frame Material		Metal	
Cone Material		Mylar (PET)	
Weight		22	g

**MECHANICAL DRAWING**

Dimensions in mm

Tolerance ±0.5mm Except Specified

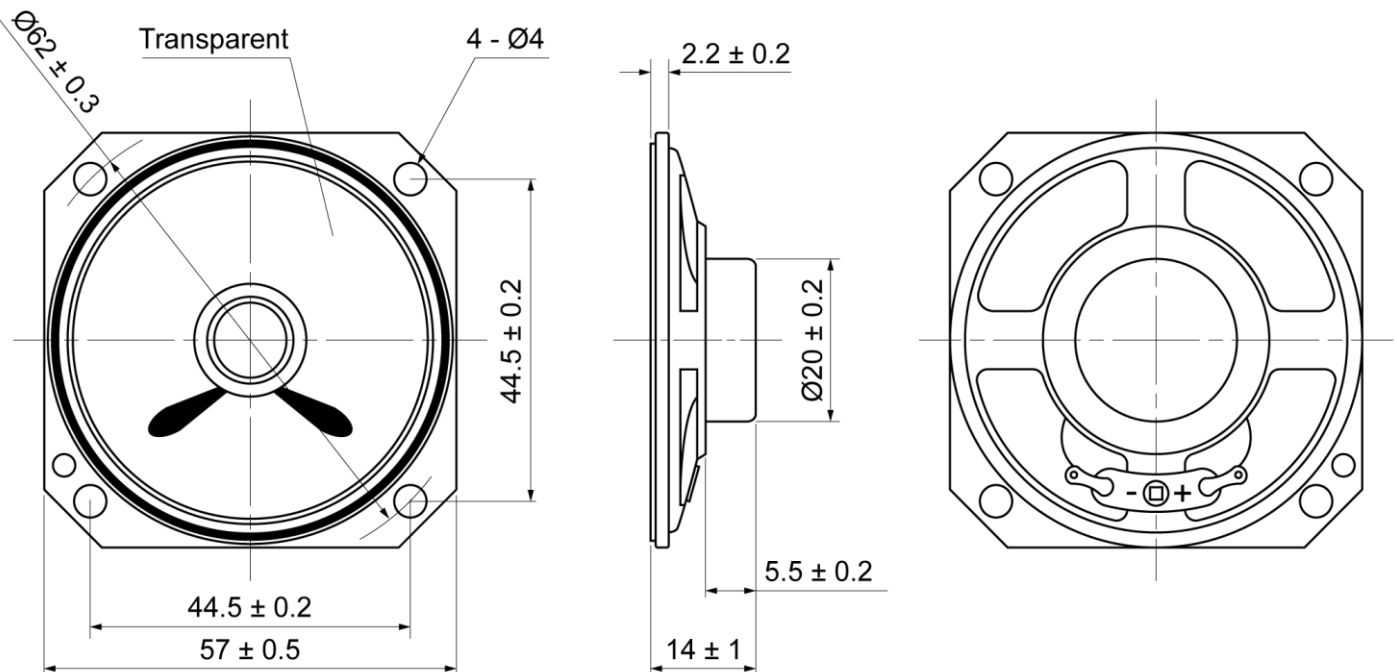

**Mylar Speaker (Internal Magnet)**

**Model: MI57TS-14H1.0W8**

**FREQUENCY RESPONSE CURVE**

