

**Mylar Speaker (Internal Magnet)**

**Model: MIU40R-20H3.0W4**



**ELECTRICAL SPECIFICATIONS**

	Condition	Parameter	Unit
Sound Pressure Level	at 0.1W, 0.1M [at 0.6, 0.8, 1.0, 1.2 KHz]	85 ± 3	dB
Impedance	at 1V, 800Hz	4 ± 15%	Ω
Rated Input Power		3	W
Max Input Power		4	W
Resonant Frequency (Fo)	at 1V	220 ± 20%	Hz
Frequency Range		Fo ~ 20000	Hz
Buzzer & Rattles	not be audible at sine wave between Fo ~ 20KHz	3.46	V
Operating Temperature		-30 ~ 75	°C
Magnet		Nd-Fe-B	
Frame Material		Metal	
Cone Material		Mylar	
Weight		21	g

**MECHANICAL DRAWING**

Dimensions in mm

Tolerance ±0.5mm Except Specified

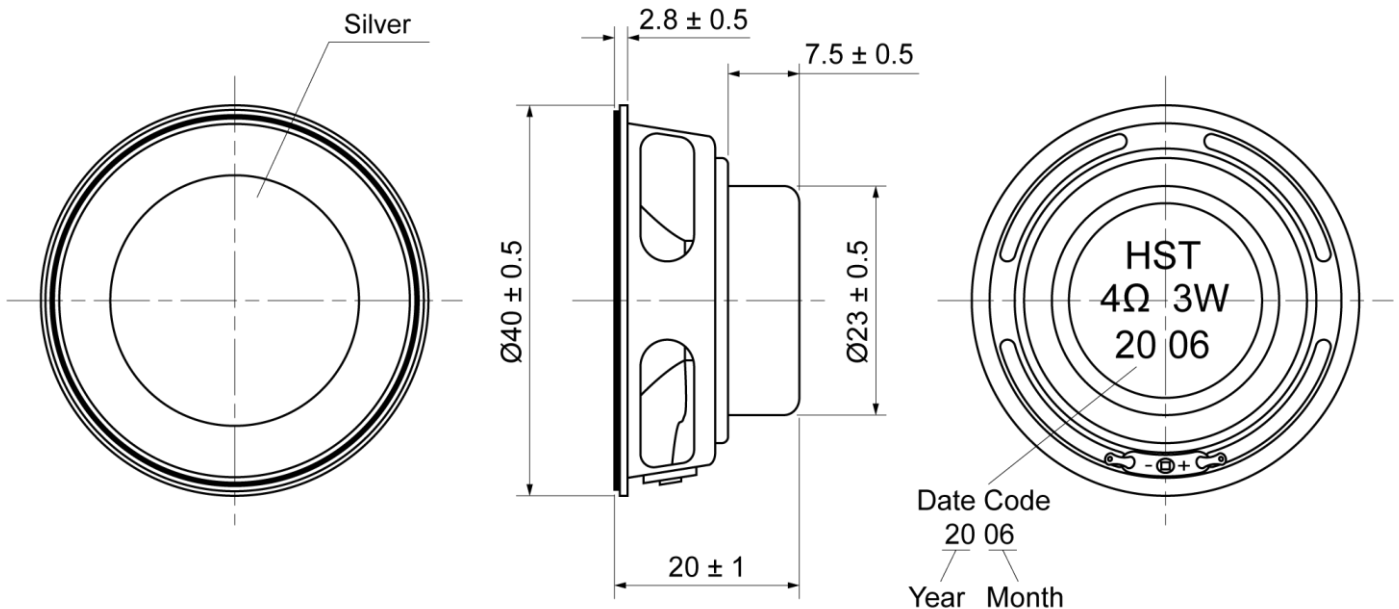

**Mylar Speaker (Internal Magnet)**

**Model: MIU40R-20H3.0W4**

**FREQUENCY RESPONSE CURVE**

