

**Plastic Frame Speaker**

**Model: OSAE40S-10P0.5W8**



**ELECTRICAL SPECIFICATIONS**

	Condition	Parameter	Unit
Sound Pressure Level	at 0.1W, 0.1M [at 1KHz]	90 ± 3	dB
Impedance	at 1V, 1000Hz	8 ± 15%	Ω
Rated Input Power		0.5	W
Max Input Power		1	W
Resonant Frequency (Fo)	at 1V	550 ± 20%	Hz
Frequency Range		Fo ~ 20000	Hz
Buzzer & Rattles	not be audible at sine wave between 150 ~ 3KHz	2	V
Operating Temperature		-20 ~ 60	°C
Magnet		Ferrite	
Frame Material		Plastic	
Cone Material		Paper	
Weight		14	g

**MECHANICAL DRAWING**

Dimensions in mm

Tolerance ±0.5mm Except Specified

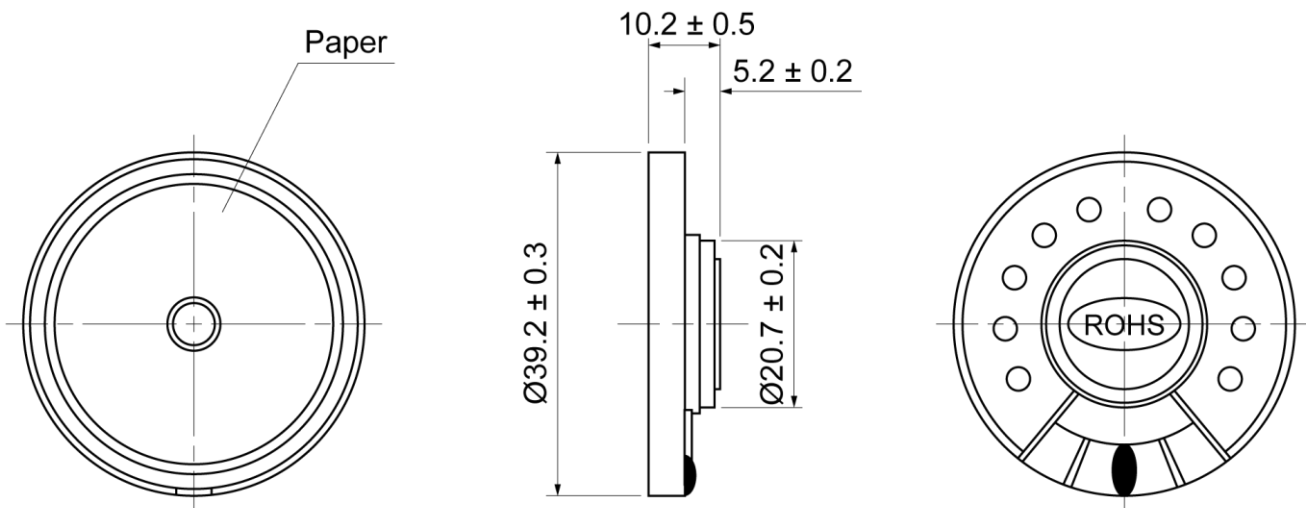

**Plastic Frame Speaker**

**Model: OSAE40S-10P0.5W8**

**FREQUENCY RESPONSE CURVE**

