

Micro Speaker

Model: OSR2515E-5.0C1.0W8A



ELECTRICAL SPECIFICATIONS

	Condition	Parameter	Unit
Sound Pressure Level	at 0.1W, 10cm [at 0.8, 1.0, 1.2, 1.5KHz]	82 ± 3	dB
Impedance	at 1V, 2000Hz	8 ± 15%	Ω
Rated Input Power		1	W
Max Input Power		1.5	W
Resonant Frequency (Fo)	at 1V, 10cm	1100 ± 30%	Hz
Frequency Range		Fo ~ 20000	Hz
Buzzer & Rattles	not be audible at sine wave between Fo ~ 5KHz	2.83	V
Operating Temperature		-20 ~ 60	°C
Magnet		Nd-Fe-B	
Frame Material		PBT	
Cone Material		Cloth	
Weight		2.4	g

MECHANICAL DRAWING

Dimensions in mm

Tolerance ±0.5mm Except Specified

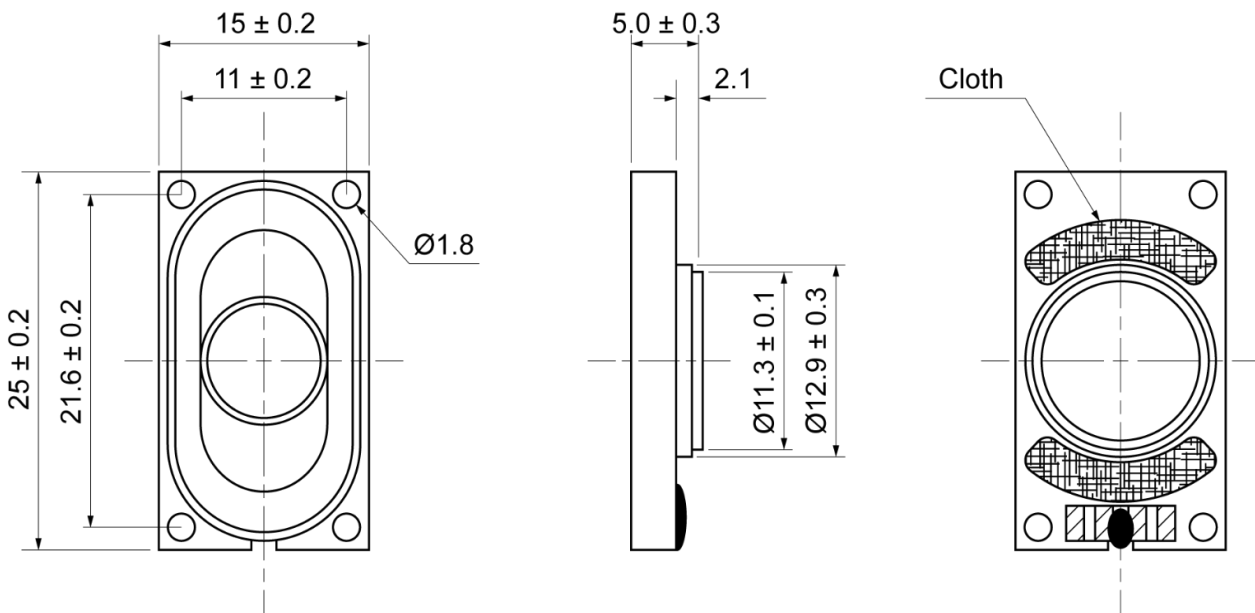

Micro Speaker

Model: OSR2515E-5.0C1.0W8A

FREQUENCY RESPONSE CURVE

