

**Ultra Thin Speaker**

**Model: OST57R-8B0.2W8C**



**ELECTRICAL SPECIFICATIONS**

	Condition	Parameter	Unit
Sound Pressure Level	at 0.1W, 0.1M [at 0.8, 1.0, 1.2, 1.5 KHz]	90 ± 3	dB
Impedance	at 1V, 800Hz	8 ± 15%	Ω
Rated Input Power		0.2	W
Max Input Power		0.5	W
Resonant Frequency (Fo)	at 1V	400 ± 20%	Hz
Frequency Range		Fo ~ 20000	Hz
Buzzer & Rattles	not be audible at sine wave between Fo ~ 20KHz	1.26	V
Operating Temperature		-25 ~ 60	°C
Magnet		Nd-Fe-B	
Frame Material		Metal	
Cone Material		Mylar (PET)	
Weight		15	g
Dustproof And Waterproof Level	IEC 529 edition 2.0 (1989)	IP65	

Note: IP protection level for speaker front side when built into sealed housing.

**MECHANICAL DRAWING**

Dimensions in mm

Tolerance ±0.5mm Except Specified

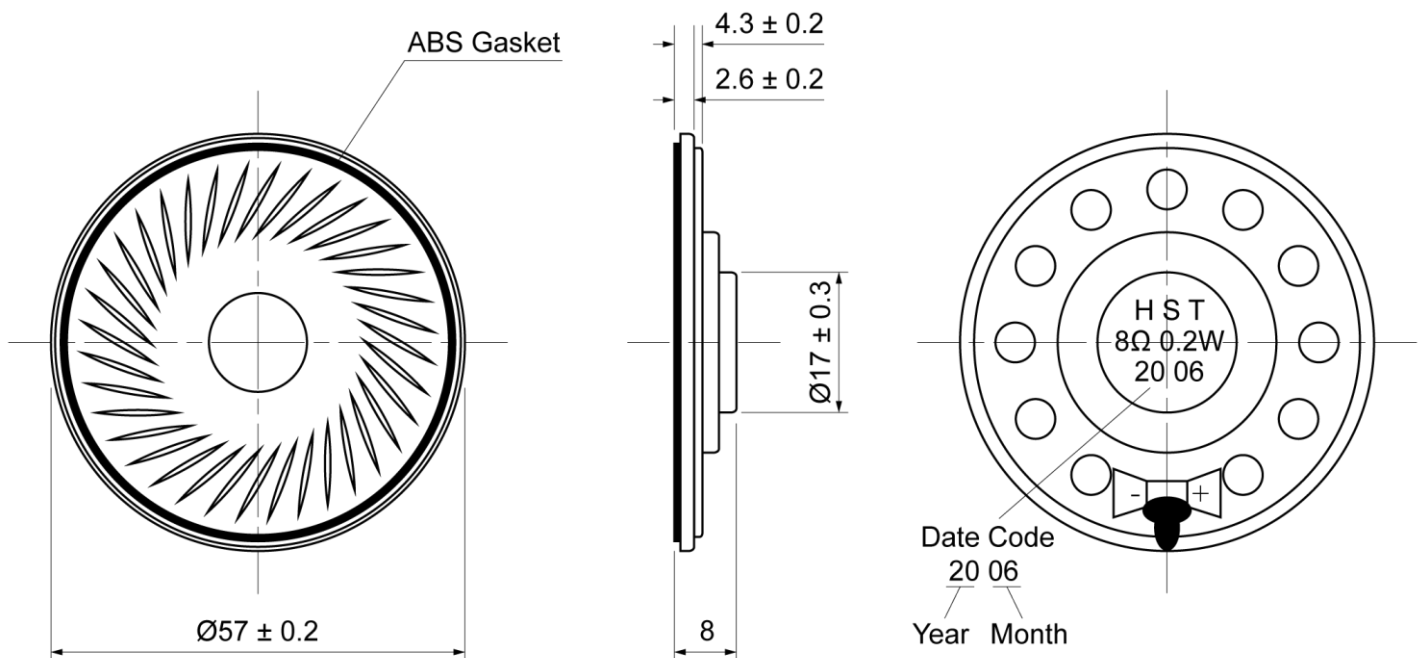

**Ultra Thin Speaker**

**Model: OST57R-8B0.2W8C**

**FREQUENCY RESPONSE CURVE**

