

Piezo Transducer (Self Drive)

Model: XPTF4020-32P



ELECTRICAL SPECIFICATIONS

	Condition	Parameter	Unit
Operating Voltage		5 ~ 15	Vdc
Rated Voltage		5	Vdc
Rated Current	at rated voltage, resonant freq.	Max. 15	mA
Resonant Frequency		3200	Hz
Sound Pressure Level	at 30cm, rated voltage, resonant freq.	Min. 90	dBA
Tone Nature		Single	
Terminal		Pin	
Operating Temperature		-20 ~ +70	°C
Housing Material		Nylon	
Weight		13	g

Notes: Parameter applying at recommend driving circuit.

RECOMMENDED DRIVING CIRCUIT

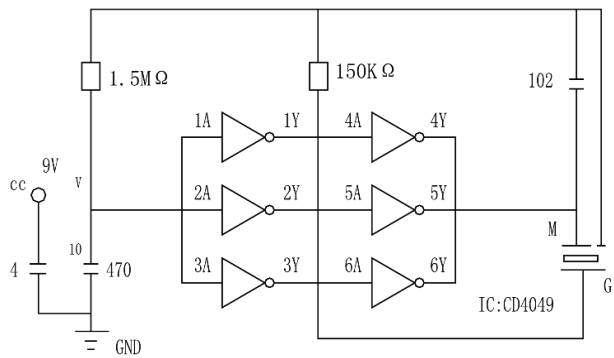

MECHANICAL DRAWING

Dimensions in mm

Tolerance ±0.5mm Except Specified

