

# Metal Oxide Varistor : TVB Series



## Plastic Encapsulated Type Varistor for Surge Protection

### ■ Features

1. RoHS compliant
2. Available for IR-reflow soldering
3. Low profile and space saving
4. Large capability to withstand high surge current
5. Low inductance construction with excellent response
6. Encapsulation material according to UL94-V0
7. Electrical characteristics of TVBDS series and TVBES series are equivalent to leaded type TVR10 series and TVR14 series respectively.
8. Operating temperature range:  
TVB7S Series/TVB9S Series: -40°C ~ +85°C  
TVBDS Series/TVBES Series: -40°C ~ +105°C
9. Storage temperature range: -40°C ~ +125°C
10. Agency recognition:  
TVB7S Series/TVB9S Series: UL/cUL/TUV  
TVBDS Series/TVBES Series: UL/cUL/TUV/CQC



### ■ Recommended Applications

1. Power supply
2. Home appliance
3. Industrial equipment
4. Telecommunication or telephone system

### ■ Part Number Code

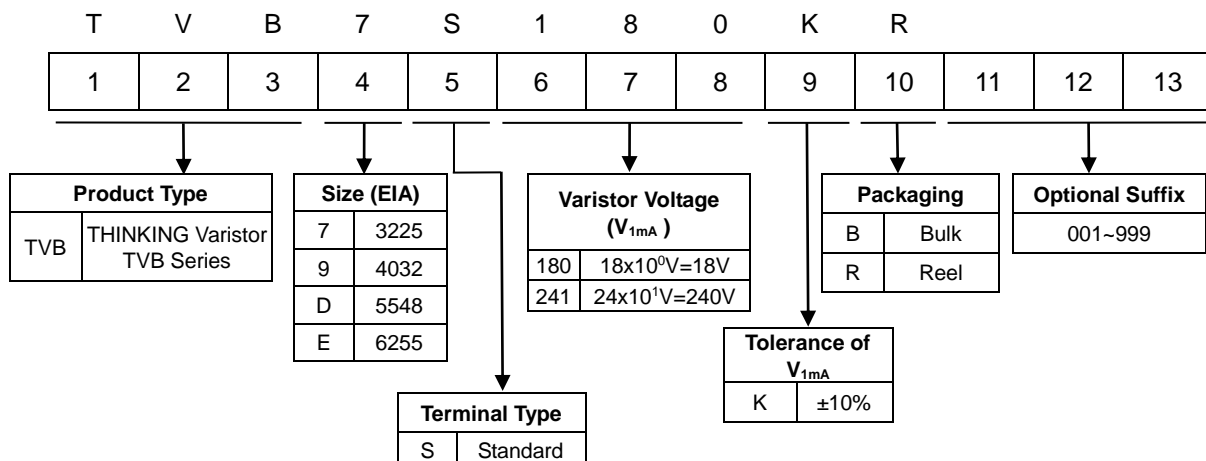

# Metal Oxide Varistor : TVB Series



## Plastic Encapsulated Type Varistor for Surge Protection

### Structures and Dimensions

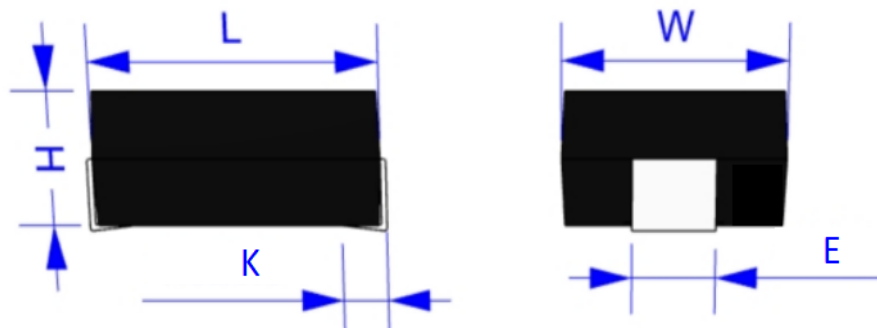

(Unit: mm)

Size (EIA)	Varistor Voltage Range (V)	L	W	H	K	E
3225	$V_{1mA}=180 \sim 271$	$8.0 \pm 0.3$	$6.3 \pm 0.3$	$3.2 \pm 0.3$	$1.5 \pm 0.3$	$3 \pm 0.3$
	$V_{1mA}=361 \sim 561$			$4.5 \pm 0.3$		
4032	$V_{1mA}=180 \sim 271$	$10.5 \pm 0.3$	$8.0 \pm 0.3$	$3.2 \pm 0.3$	$1.5 \pm 0.3$	$3 \pm 0.3$
	$V_{1mA}=301 \sim 751$			$4.5 \pm 0.3$		
5548	$V_{1mA}=270 \sim 361$	$14.0 \pm 0.3$	$12.2 \pm 0.3$	$4.0 \pm 0.3$	$2.0 \pm 0.3$	$3.0 \pm 0.3$
	$V_{1mA}=391 \sim 751$			$6.0 \pm 0.3$		
6225	$V_{1mA}=270 \sim 361$	$15.8 \pm 0.3$	$14.0 \pm 0.3$	$4.0 \pm 0.3$	$2.0 \pm 0.3$	$4.0 \pm 0.3$
	$V_{1mA}=391 \sim 751$			$6.0 \pm 0.3$		

### Soldering Pads

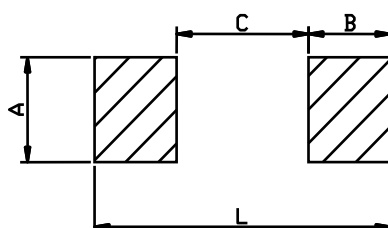

(Unit: mm)

Item	A	B	C	L	
Size (EIA)	3225	3.5	2.8	4.5	10.1
	4032	3.5	2.8	6.5	12.1
	5548	3.5	3.3	8.4	--
	6225	4.5	3.3	10.2	--

# Metal Oxide Varistor : TVB Series



## Plastic Encapsulated Type Varistor for Surge Protection

### ■ Electrical Characteristics

#### TVB7S Series (3225 Size)

Part No.	Varistor Voltage (@ 1mA DC)	Max. Continuous Voltage		Max. Clamping Voltage (8/20μs)		Max. Surge Current (8/20μs)	Max. Energy (10/1000μs)	Rated Power
	V <sub>1mA</sub> (V)	V <sub>AC(rms)</sub> (V)	V <sub>DC</sub> (V)	V <sub>P</sub> (V)	I <sub>P</sub> (A)	I <sub>max</sub> (A)	W <sub>max</sub> (J)	P (W)
TVB7S180	18 (16~20)	11	14	36	1.0	150	0.6	0.01
TVB7S220	22 (20~24)	14	18	43	1.0	150	0.7	0.01
TVB7S270	27 (24~30)	17	22	53	1.0	150	0.9	0.01
TVB7S330	33 (30~36)	20	26	65	1.0	150	1.1	0.01
TVB7S390	39 (35~43)	25	31	77	1.0	150	1.2	0.01
TVB7S470	47 (42~52)	30	38	93	1.0	150	1.5	0.01
TVB7S560	56 (50~62)	35	45	110	1.0	150	1.8	0.01
TVB7S680	68 (61~75)	40	56	135	1.0	150	2.2	0.01
TVB7S820	82 (74~90)	50	65	135	5.0	400	2.5	0.1
TVB7S101	100 (90~110)	60	85	165	5.0	400	3.0	0.1
TVB7S121	120 (108~132)	75	100	200	5.0	400	4.0	0.1
TVB7S151	150 (135~165)	95	125	250	5.0	400	6.0	0.1
TVB7S181	180 (162~198)	115	150	300	5.0	400	6.5	0.1
TVB7S201	200 (180~220)	130	170	340	5.0	400	7.0	0.1
TVB7S221	220 (198~242)	140	180	360	5.0	400	7.5	0.1
TVB7S241	240 (216~264)	150	200	395	5.0	400	9.0	0.1
TVB7S271	270 (243~297)	175	225	455	5.0	400	9.5	0.1
TVB7S361	360 (324~396)	230	300	595	5.0	400	10.0	0.1
TVB7S391	390 (351~429)	250	320	650	5.0	400	11.0	0.1
TVB7S431	430 (387~473)	275	350	710	5.0	400	13.0	0.1
TVB7S471	470 (423~517)	300	385	775	5.0	400	15.0	0.1
TVB7S511	510 (459~561)	320	410	845	5.0	400	16.5	0.1
TVB7S561	560 (504~616)	350	450	930	5.0	400	18.0	0.1

# Metal Oxide Varistor : TVB Series



## Plastic Encapsulated Type Varistor for Surge Protection

### TVB9S Series (4032 Size)

Part No.	Varistor Voltage (@ 1mA DC)	Max. Continuous Voltage		Max. Clamping Voltage (8/20μs)		Max. Surge Current (8/20μs)	Max. Energy (10/1000μs)	Rated Power
	V <sub>1mA</sub> (V)	V <sub>AC(rms)</sub> (V)	V <sub>DC</sub> (V)	V <sub>P</sub> (V)	I <sub>P</sub> (A)	I <sub>max</sub> (A)	W <sub>max</sub> (J)	P (W)
TVB9S180	18 (16~20)	11	14	36	2.5	300	1.1	0.02
TVB9S220	22 (20~24)	14	18	43	2.5	300	1.3	0.02
TVB9S270	27 (24~30)	17	22	53	2.5	300	1.6	0.02
TVB9S330	33 (30~36)	20	26	65	2.5	300	2.0	0.02
TVB9S390	39 (35~43)	25	31	77	2.5	300	2.4	0.02
TVB9S470	47 (42~52)	30	38	93	2.5	300	2.8	0.02
TVB9S560	56 (50~62)	35	45	110	2.5	300	3.4	0.02
TVB9S680	68 (61~75)	40	56	135	2.5	300	4.1	0.02
TVB9S820	82 (74~90)	50	65	135	10	1200	6.5	0.25
TVB9S101	100 (90~110)	60	85	165	10	1200	7.0	0.25
TVB9S121	120 (108~132)	75	100	200	10	1200	9.0	0.25
TVB9S151	150 (135~165)	95	125	250	10	1200	11.0	0.25
TVB9S181	180 (162~198)	115	150	300	10	1200	13.0	0.25
TVB9S201	200 (180~220)	130	170	340	10	1200	15.0	0.25
TVB9S221	220 (198~242)	140	180	360	10	1200	18.0	0.25
TVB9S241	240 (216~264)	150	200	395	10	1200	18.5	0.25
TVB9S271	270 (243~297)	175	225	455	10	1200	21.0	0.25
TVB9S301	300 (270~330)	195	250	500	10	1200	21.5	0.25
TVB9S331	330 (297~363)	215	275	550	10	1200	22.0	0.25
TVB9S361	360 (324~396)	230	300	595	10	1200	23.0	0.25
TVB9S391	390 (351~429)	250	320	650	10	1200	25.0	0.25
TVB9S431	430 (387~473)	275	350	710	10	1200	29.0	0.25
TVB9S471	470 (423~517)	300	385	775	10	1200	30.0	0.25
TVB9S511	510 (459~561)	320	410	845	10	1200	33.0	0.25
TVB9S561	560 (504~616)	350	450	930	10	1200	33.0	0.25
TVB9S621	620 (558~682)	395	510	1020	10	1200	35.0	0.25
TVB9S681	680 (612~748)	420	560	1120	10	1200	35.0	0.25
TVB9S751	750 (675~825)	460	615	1235	10	1200	50.5	0.25

# Metal Oxide Varistor : TVB Series



## Plastic Encapsulated Type Varistor for Surge Protection

### TVBDS Series (5548 Size)

Part No.	Varistor Voltage (@ 1mA DC)	Max. Continuous Voltage		Max. Clamping Voltage (8/20 $\mu$ s)		Max. Surge Current (8/20 $\mu$ s)	Max. Energy (10/1000 $\mu$ s)	Rated Power
	V <sub>1mA</sub> (V)	V <sub>AC(rms)</sub> (V)	V <sub>DC</sub> (V)	V <sub>P</sub> (V)	I <sub>P</sub> (A)	I <sub>max</sub> (A)	W <sub>max</sub> (J)	P (W)
TVBDS270	27(24~30)	17	22	53	5	500	3.9	0.05
TVBDS330	33(30~36)	20	26	65	5	500	4.8	0.05
TVBDS390	39(35~43)	25	31	77	5	500	5.6	0.05
TVBDS470	47(42~52)	30	38	93	5	500	6.8	0.05
TVBDS560	56(50~62)	35	45	125	5	500	8.1	0.05
TVBDS680	68(61~75)	40	56	135	5	500	9.8	0.05
TVBDS820	82(74~90)	50	65	150	25	3500	14	0.4
TVBDS101	100(90~110)	60	85	165	25	3500	17	0.4
TVBDS121	120(108~132)	75	100	200	25	3500	20	0.4
TVBDS151	150(135~165)	95	125	250	25	3500	25	0.4
TVBDS181	180(162~198)	115	150	300	25	3500	30	0.4
TVBDS201	205(185~226)	130	170	340	25	3500	35	0.4
TVBDS221	220(198~242)	140	180	360	25	3500	39	0.4
TVBDS241	240(216~264)	150	200	395	25	3500	42	0.4
TVBDS271	270(243~297)	175	225	455	25	3500	49	0.4
TVBDS301	300(270~330)	195	250	500	25	3500	53	0.4
TVBDS331	330(297~363)	215	275	550	25	3500	58	0.4
TVBDS361	360(324~396)	230	300	595	25	3500	65	0.4
TVBDS391	390(351~429)	250	320	650	25	3500	70	0.4
TVBDS431	430(387~473)	275	350	710	25	3500	80	0.4
TVBDS471	475(428~523)	300	385	775	25	3500	85	0.4
TVBDS511	510(459~561)	320	410	845	25	3500	92	0.4
TVBDS561	560(504~616)	350	450	930	25	3500	92	0.4
TVBDS621	620(558~682)	395	510	1020	25	3500	95	0.4
TVBDS681	680(612~748)	420	560	1120	25	3500	98	0.4
TVBDS751	750(675~825)	465	615	1235	25	3500	100	0.4

# Metal Oxide Varistor : TVB Series



## Plastic Encapsulated Type Varistor for Surge Protection

### TVES Series (6255 Size)





Part No.	Varistor Voltage (@ 1mA DC)	Max. Continuous Voltage		Max. Clamping Voltage (8/20μs)		Max. Surge Current (8/20μs)	Max. Energy (10/1000μs)	Rated Power
	V <sub>1mA</sub> (V)	V <sub>AC(rms)</sub> (V)	V <sub>DC</sub> (V)	V <sub>P</sub> (V)	I <sub>P</sub> (A)	I <sub>max</sub> (A)	W <sub>max</sub> (J)	P (W)
TVBES270	27(24~30)	17	22	53	10	1000	6	0.1
TVBES330	33(30~36)	20	26	65	10	1000	7	0.1
TVBES390	39(35~43)	25	31	77	10	1000	8	0.1
TVBES470	47(42~52)	30	38	93	10	1000	10	0.1
TVBES560	56(50~62)	35	45	125	10	1000	12	0.1
TVBES680	68(61~75)	40	56	135	10	1000	15	0.1
TVBES820	82(74~90)	50	65	150	50	4500	21	0.6
TVBES101	100(90~110)	60	85	165	50	4500	26	0.6
TVBES121	120(108~132)	75	100	200	50	4500	31	0.6
TVBES151	150(135~165)	95	125	250	50	4500	40	0.6
TVBES181	180(162~198)	115	150	300	50	4500	47	0.6
TVBES201	205(185~226)	130	170	340	50	4500	52	0.6
TVBES221	220(198~242)	140	180	360	50	4500	58	0.6
TVBES241	240(216~264)	150	200	395	50	4500	64	0.6
TVBES271	270(243~297)	175	225	455	50	4500	67	0.6
TVBES301	300(270~330)	195	250	500	50	4500	70	0.6
TVBES331	330(297~363)	215	275	550	50	4500	72	0.6
TVBES361	360(324~396)	230	300	595	50	4500	76	0.6
TVBES391	390(351~429)	250	320	650	50	4500	82	0.6
TVBES431	430(387~473)	275	350	710	50	4500	93	0.6
TVBES471	475(428~523)	300	385	775	50	4500	99	0.6
TVBES511	510(459~561)	320	410	845	50	4500	107	0.6
TVBES561	560(504~616)	350	450	930	50	4500	113	0.6
TVBES621	620(558~682)	395	510	1020	50	4500	125	0.6
TVBES681	680(612~748)	420	560	1120	50	4500	128	0.6
TVBES751	750(675~825)	460	615	1235	50	4500	134	0.6

# Metal Oxide Varistor : TVB Series

Plastic Encapsulated Type Varistor for Surge Protection



## ■ Safety Approvals



Certified Model No.	Agency		Certified Model No.	Agency	
					
	UL1449 4 <sup>th</sup> & cUL	EN/IEC 61051-1 IEC 61051-2 IEC 61051-2-2		UL1449 4 <sup>th</sup> & cUL	EN/IEC 61051-1 IEC 61051-2 IEC 61051-2-2
	E314979	J50282205		E314979	J50282205
TVB7S180	√	√	TVB9S180	√	√
TVB7S220	√	√	TVB9S220	√	√
TVB7S270	√	√	TVB9S270	√	√
TVB7S330	√	√	TVB9S330	√	√
TVB7S390	√	√	TVB9S390	√	√
TVB7S470	√	√	TVB9S470	√	√
TVB7S560	√	√	TVB9S560	√	√
TVB7S680	√	√	TVB9S680	√	√
TVB7S820	√	√	TVB9S820	√	√
TVB7S101	√	√	TVB9S101	√	√
TVB7S121	√	√	TVB9S121	√	√
TVB7S151	√	√	TVB9S151	√	√
TVB7S181	√	√	TVB9S181	√	√
TVB7S201	√	√	TVB9S201	√	√
TVB7S221	√	√	TVB9S221	√	√
TVB7S241	√	√	TVB9S241	√	√
TVB7S271	√	√	TVB9S271	√	√
TVB7S361	√	√	TVB9S331	√	√
TVB7S391	√	√	TVB9S361	√	√
TVB7S431	√	√	TVB9S391	√	√
TVB7S471	√	√	TVB9S431	√	√
TVB7S511	√	√	TVB9S471	√	√
TVB7S561	√	√	TVB9S511	√	√
			TVB9S561	√	√
			TVB9S621	√	√
			TVB9S681	√	√
			TVB9S751	√	√

# Metal Oxide Varistor : TVB Series



## Plastic Encapsulated Type Varistor for Surge Protection

### ■ Safety Approvals

Certified Model No.	Agency				
					
	UL1449 5 <sup>th</sup> & cUL	EN/IEC 61051-1 IEC 61051-2 IEC 61051-2-2	IEC 62368-1:2018 G.8.1	GB/T10193-1997 GB/T10194-1997	GB4943.1-2011 GB 8898-2011
	E314979	J50517635		Pending	
TVBDS270	√	√		√	
TVBDS330	√	√		√	
TVBDS390	√	√		√	
TVBDS470	√	√		√	
TVBDS560	√	√		√	
TVBDS680	√	√		√	
TVBDS820	√	√		√	
TVBDS101	√	√		√	
TVBDS121	√	√		√	
TVBDS151	√	√		√	
TVBDS181	√	√	√	√	
TVBDS201	√	√	√	√	
TVBDS221	√	√	√	√	
TVBDS241	√	√	√	√	
TVBDS271	√	√	√	√	
TVBDS301	√	√	√	√	
TVBDS331	√	√	√	√	
TVBDS361	√	√	√	√	
TVBDS391	√	√	√	√	
TVBDS431	√	√	√	√	√
TVBDS471	√	√	√	√	√
TVBDS511	√	√	√	√	√
TVBDS561	√	√	√	√	√
TVBDS621	√	√	√	√	√
TVBDS681	√	√	√	√	√
TVBDS751	√	√	√	√	√





# Metal Oxide Varistor : TVB Series

Plastic Encapsulated Type Varistor for Surge Protection



## ■ Safety Approvals

Certified Model No.	Agency				
					
	UL1449 4 <sup>th</sup> & cUL	EN/IEC 61051-1 IEC 61051-2 IEC 61051-2-2	IEC62368-1:2018 G.8.1	GB/T10193-1997 GB/T10194-1997	GB4943.1-2011GB88 98-2011
	E314979	J50477949		CQC20001267007	
TVBES270	√	√		√	
TVBES330	√	√		√	
TVBES390	√	√		√	
TVBES470	√	√		√	
TVBES560	√	√		√	
TVBES680	√	√		√	
TVBES820	√	√		√	
TVBES101	√	√		√	
TVBES121	√	√		√	
TVBES151	√	√		√	
TVBES181	√	√	√	√	
TVBES201	√	√	√	√	
TVBES221	√	√	√	√	
TVBES241	√	√	√	√	
TVBES271	√	√	√	√	
TVBES301	√	√	√	√	
TVBES331	√	√	√	√	
TVBES361	√	√	√	√	
TVBES391	√	√	√	√	
TVBES431	√	√	√	√	√
TVBES471	√	√	√	√	√
TVBES511	√	√	√	√	√
TVBES561	√	√	√	√	√
TVBES621	√	√	√	√	√
TVBES681	√	√	√	√	√
TVBES751	√	√	√	√	√

# Metal Oxide Varistor : TVB Series



## Plastic Encapsulated Type Varistor for Surge Protection

### ■ Power Derating Curve

- TVB7S Series & TVB9S Series

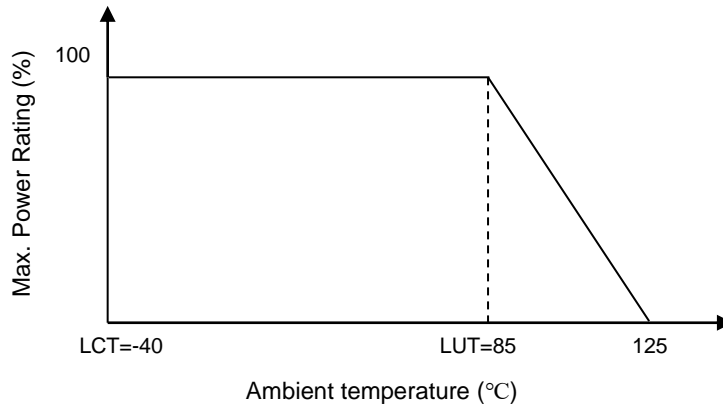

- TVBDS Series & TVBES Series

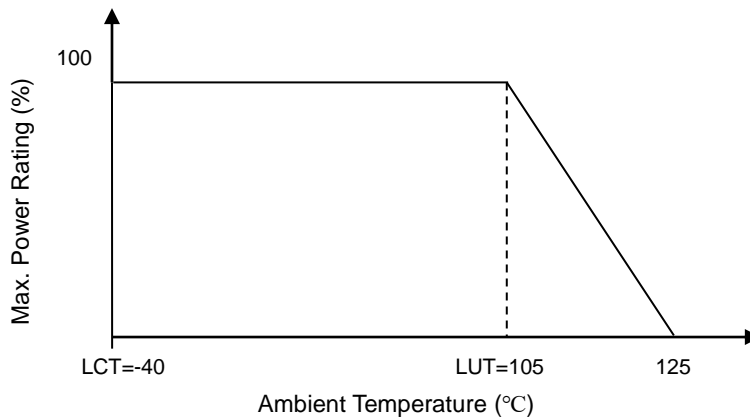

### ■ Surge Current Standard Waveform

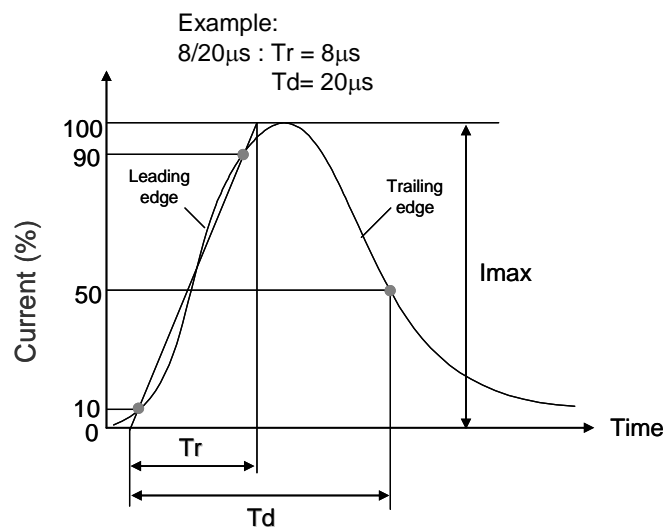

# Metal Oxide Varistor : TVB Series



## Plastic Encapsulated Type Varistor for Surge Protection

### ■ Max. Surge Current Derating Curves

TVB7S180 to TVB7S680

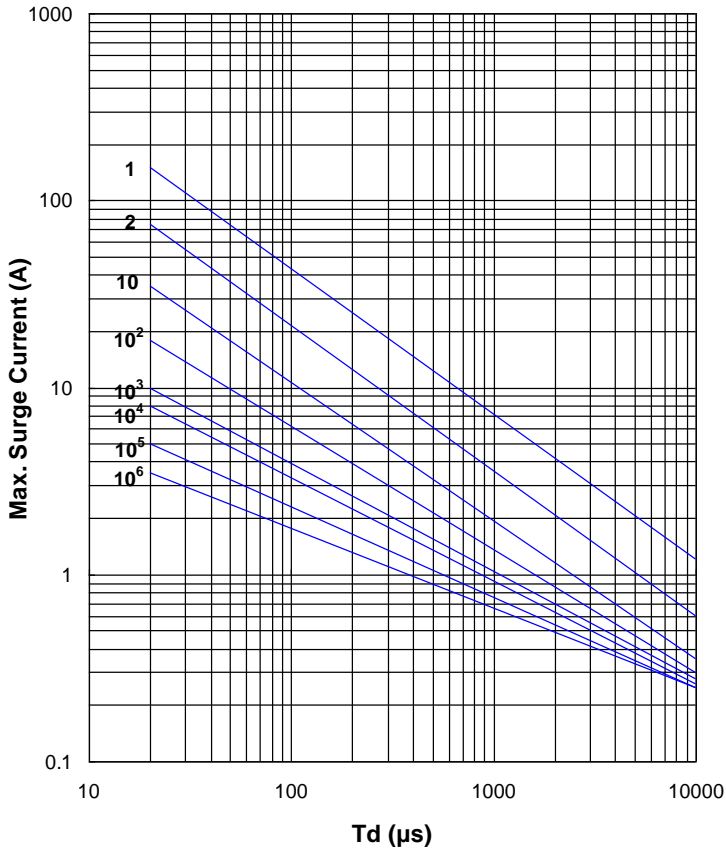

TVB7S820 to TVB7S561

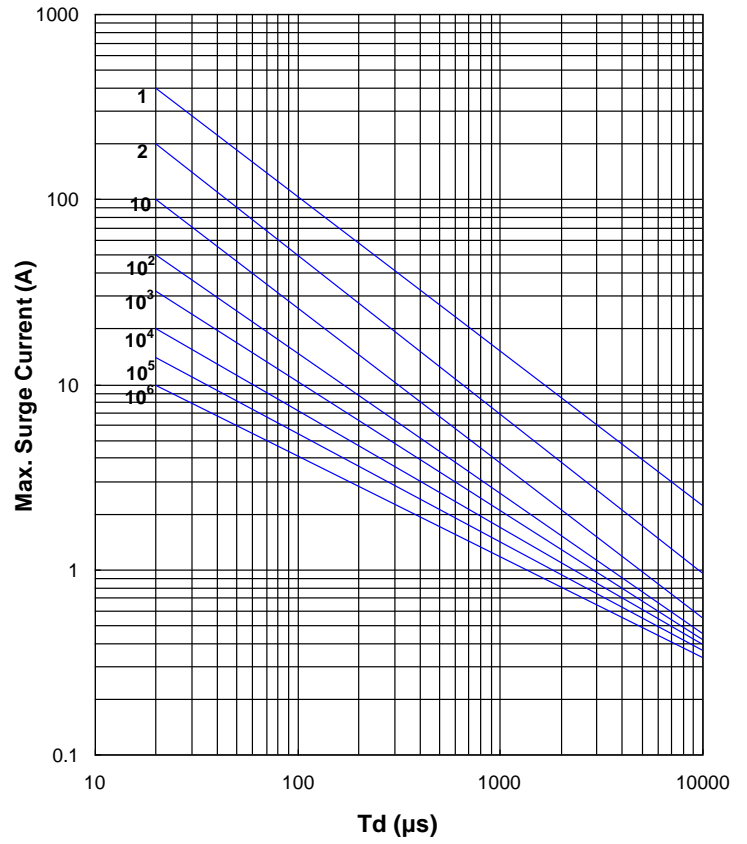

TVB9S180 to TVB9S680

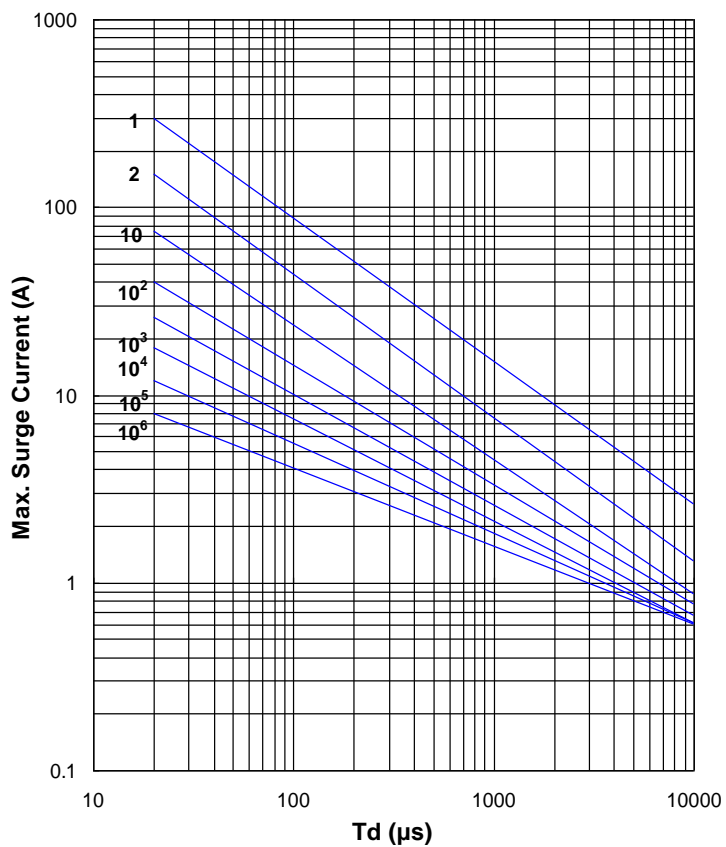

TVB9S820 to TVB9S751

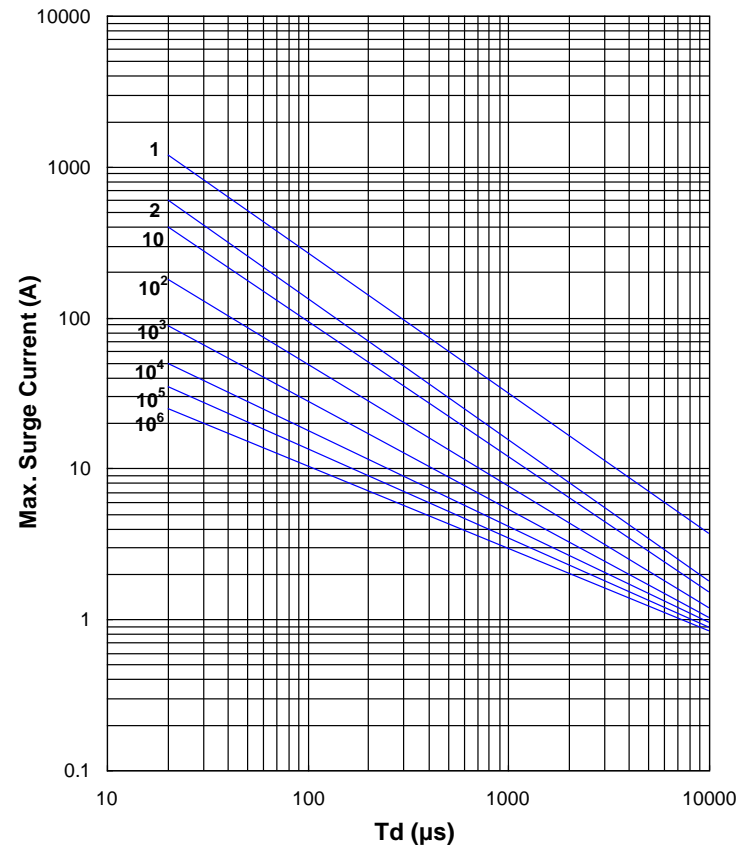

# Metal Oxide Varistor : TVB Series



## Plastic Encapsulated Type Varistor for Surge Protection

### Max. Surge Current Derating Curves

TVBDS270 to TVBDS680

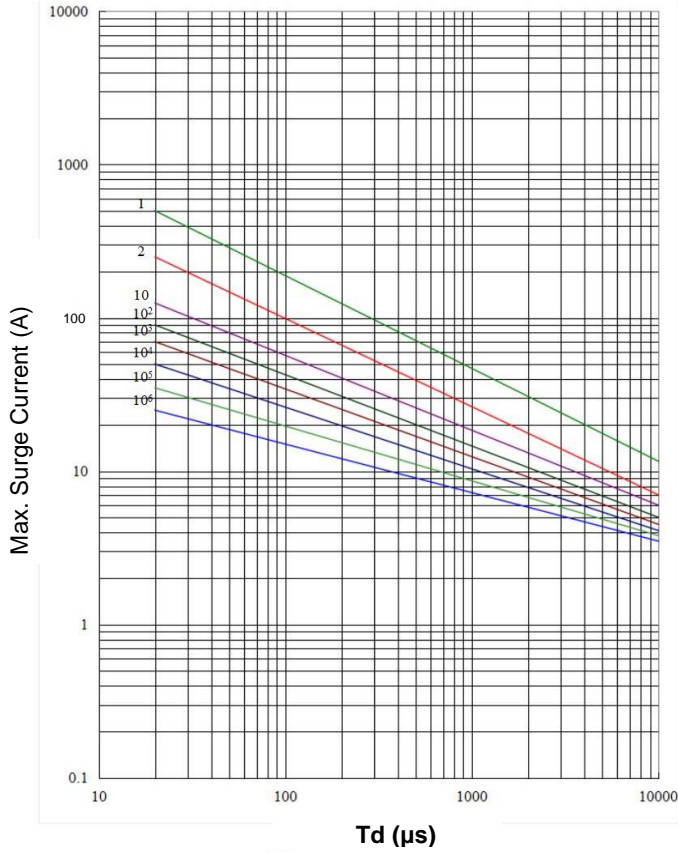

TVB DS820 to TVB DS751

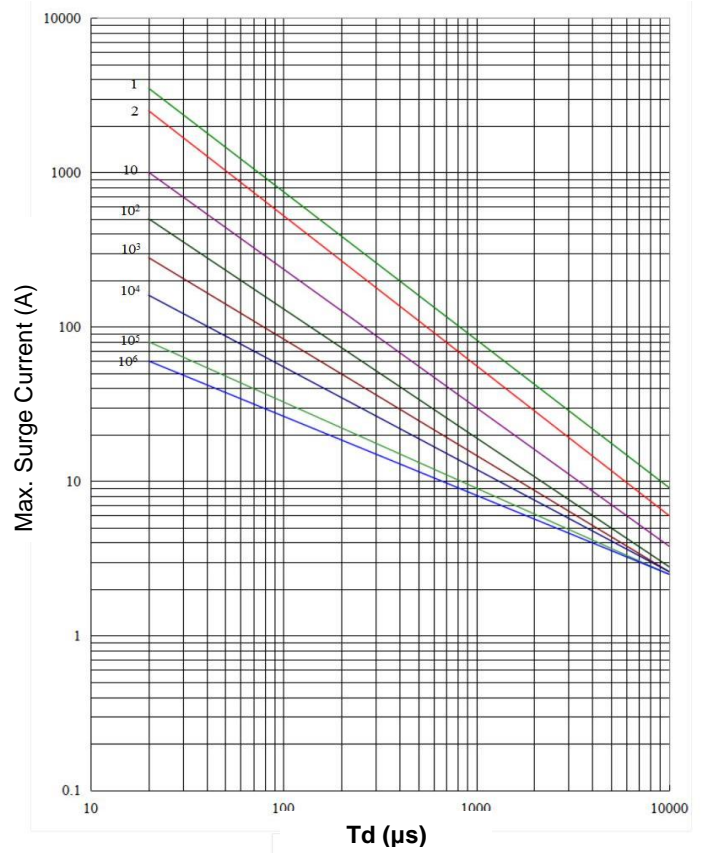

TVBES270 to TVBES680

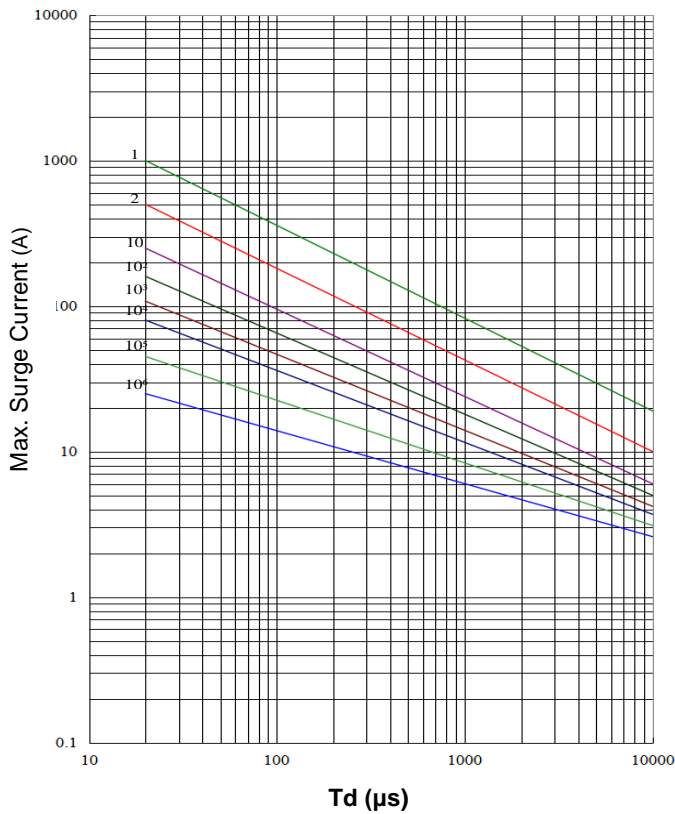

TVBES820 to TVBES751

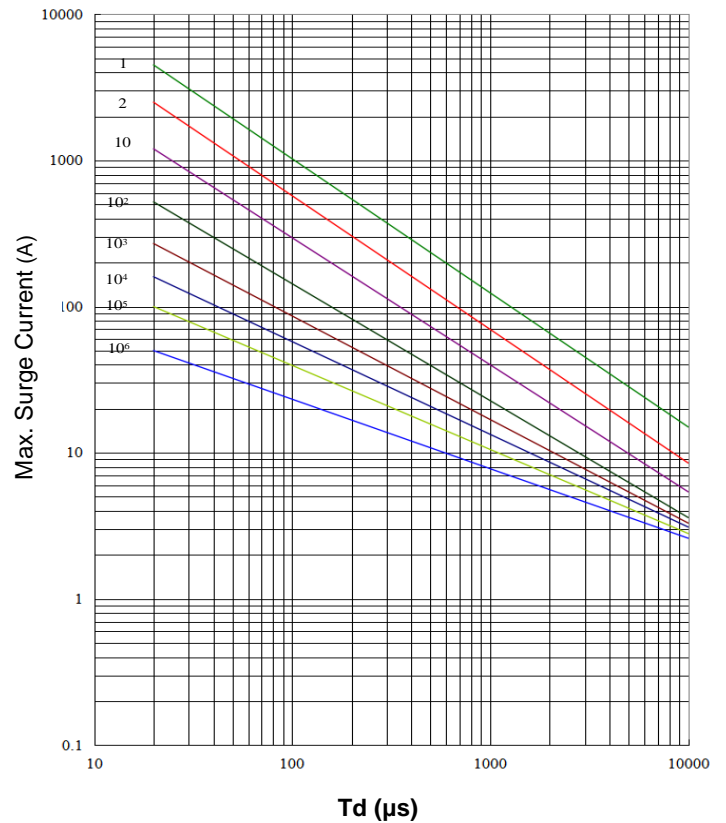

# Metal Oxide Varistor : TVB Series

Plastic Encapsulated Type Varistor for Surge Protection



## Max. Leakage Current and Max. Clamping Voltage Curves

Max. Leakage Current and Max. Clamping Voltage Curves (TVB7S180 to TVB7S680)

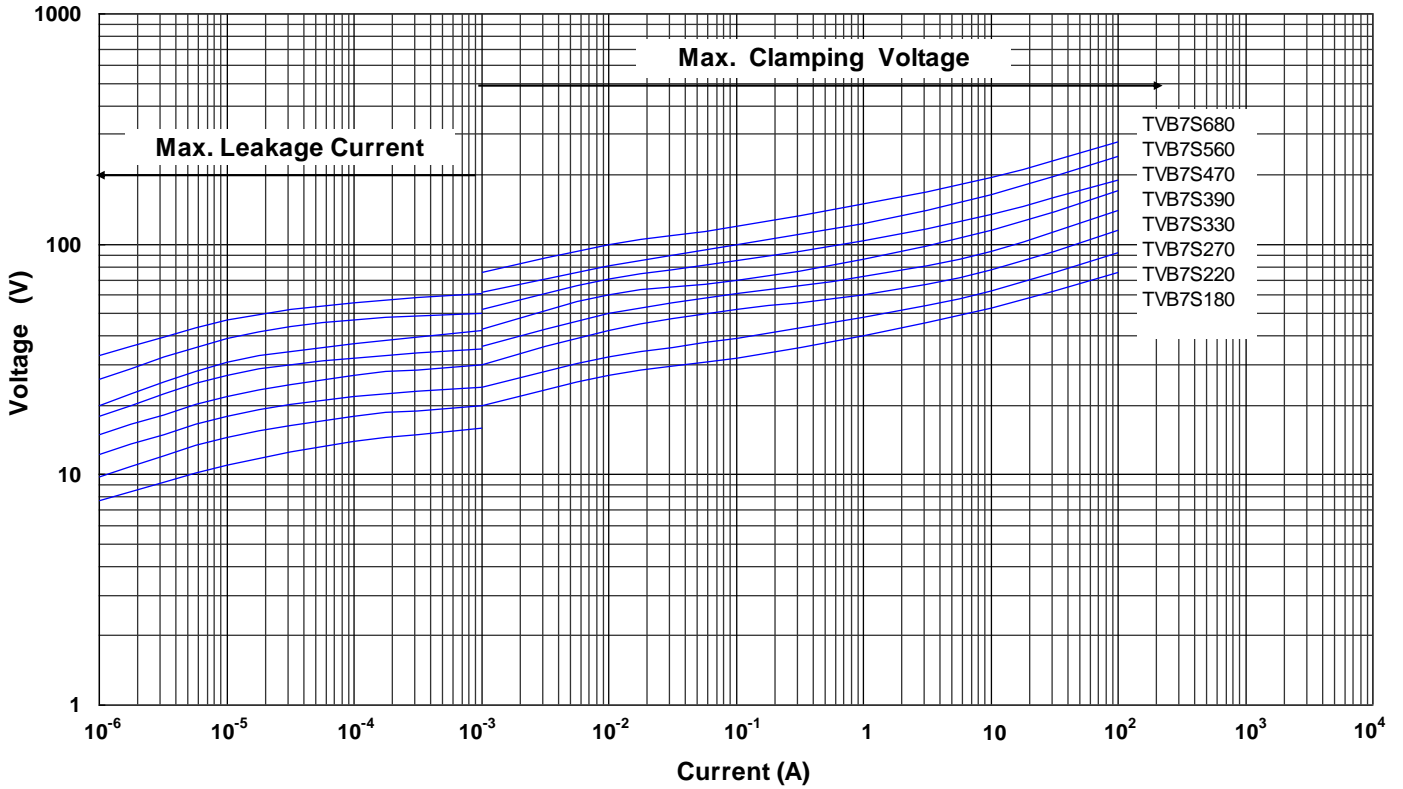

Max. Leakage Current and Max. Clamping Voltage Curves (TVB7S820 to TVB7S561)

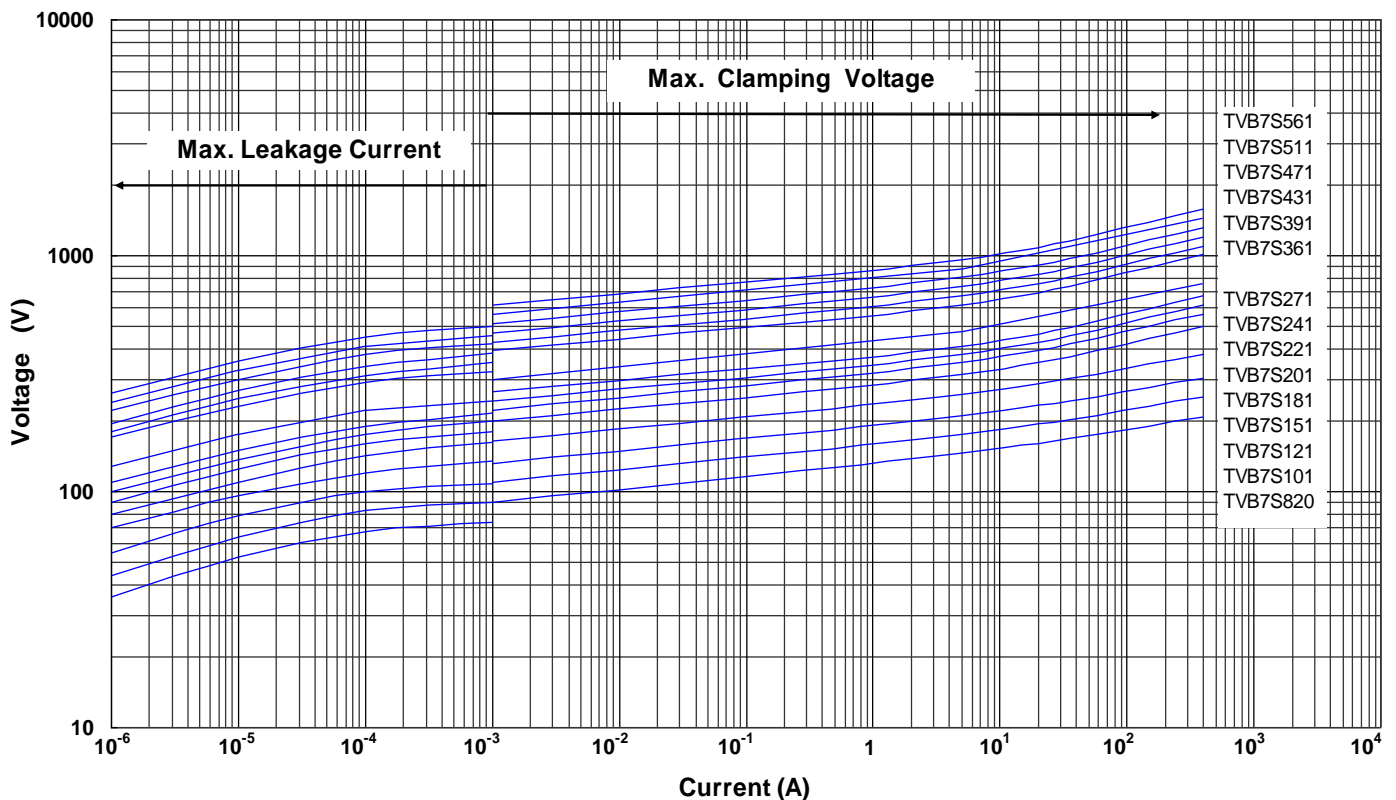

# Metal Oxide Varistor : TVB Series

Plastic Encapsulated Type Varistor for Surge Protection



## Max. Leakage Current and Max. Clamping Voltage Curves

Max. Leakage Current and Max. Clamping Voltage Curves (TVB9S180 to TVB9S680)

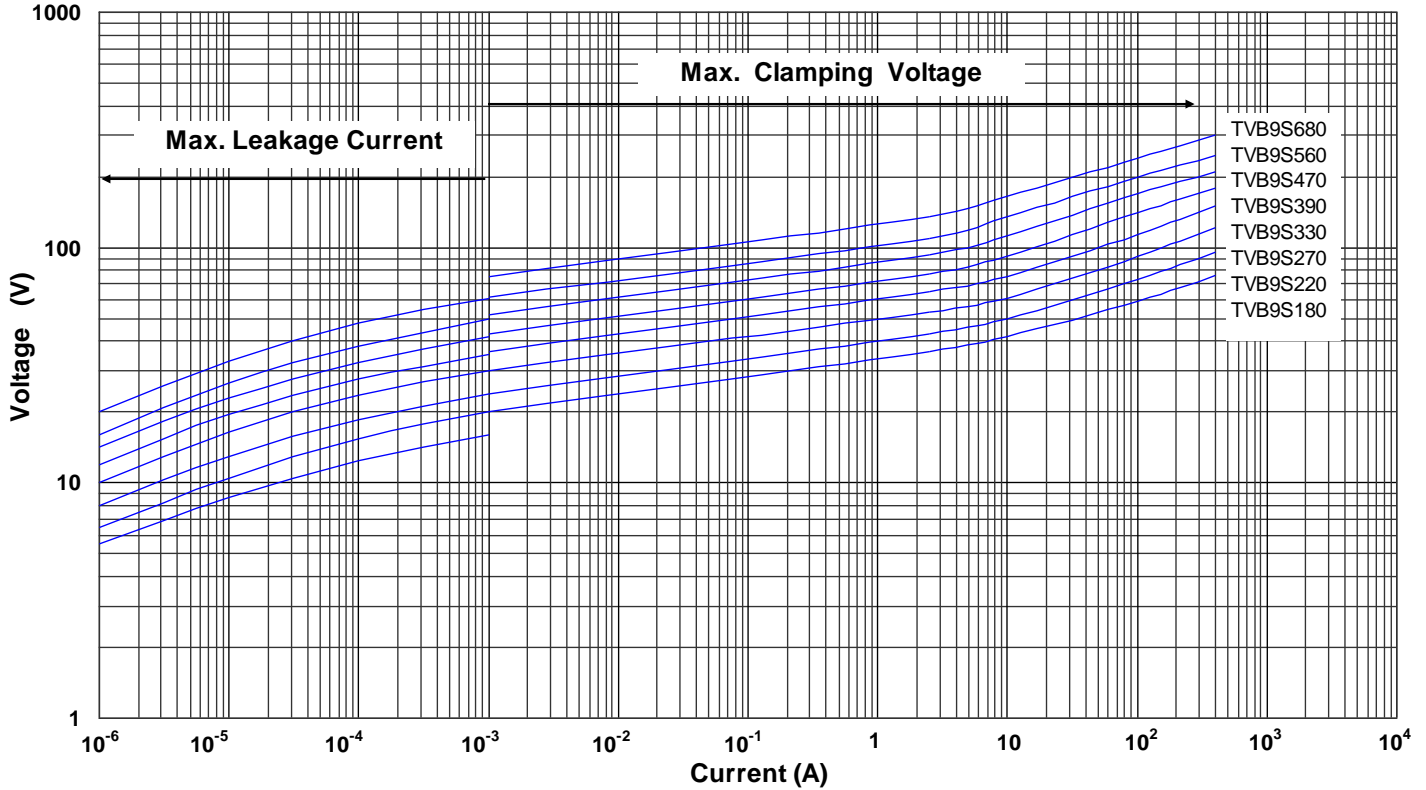

Max. Leakage Current and Max. Clamping Voltage Curves (TVB9S820 to TVB9S471)

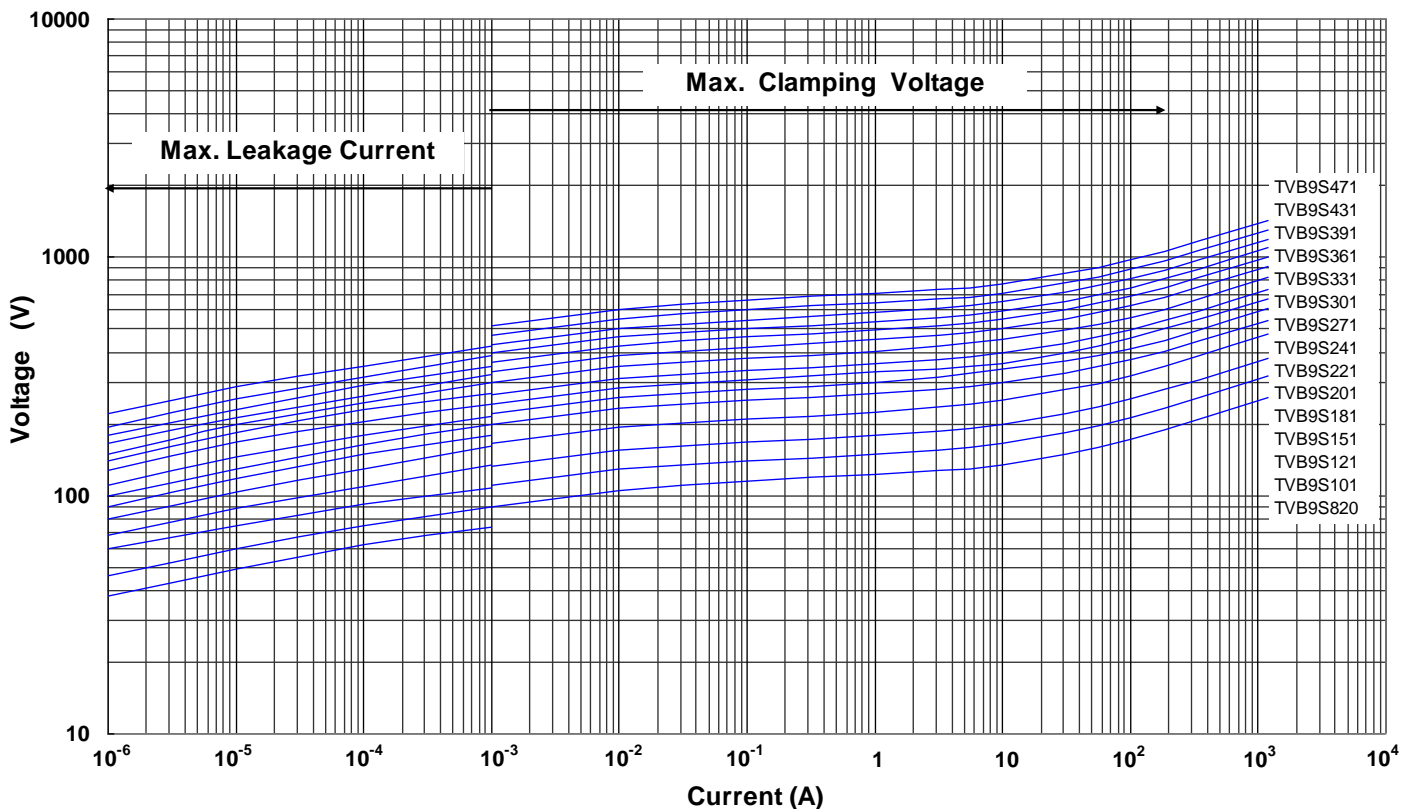

# Metal Oxide Varistor : TVB Series



## Plastic Encapsulated Type Varistor for Surge Protection

### ■ Max. Leakage Current and Max. Clamping Voltage Curves

Max. Leakage Current and Max. Clamping Voltage Curves (TVB9S511 to TVB9S751)

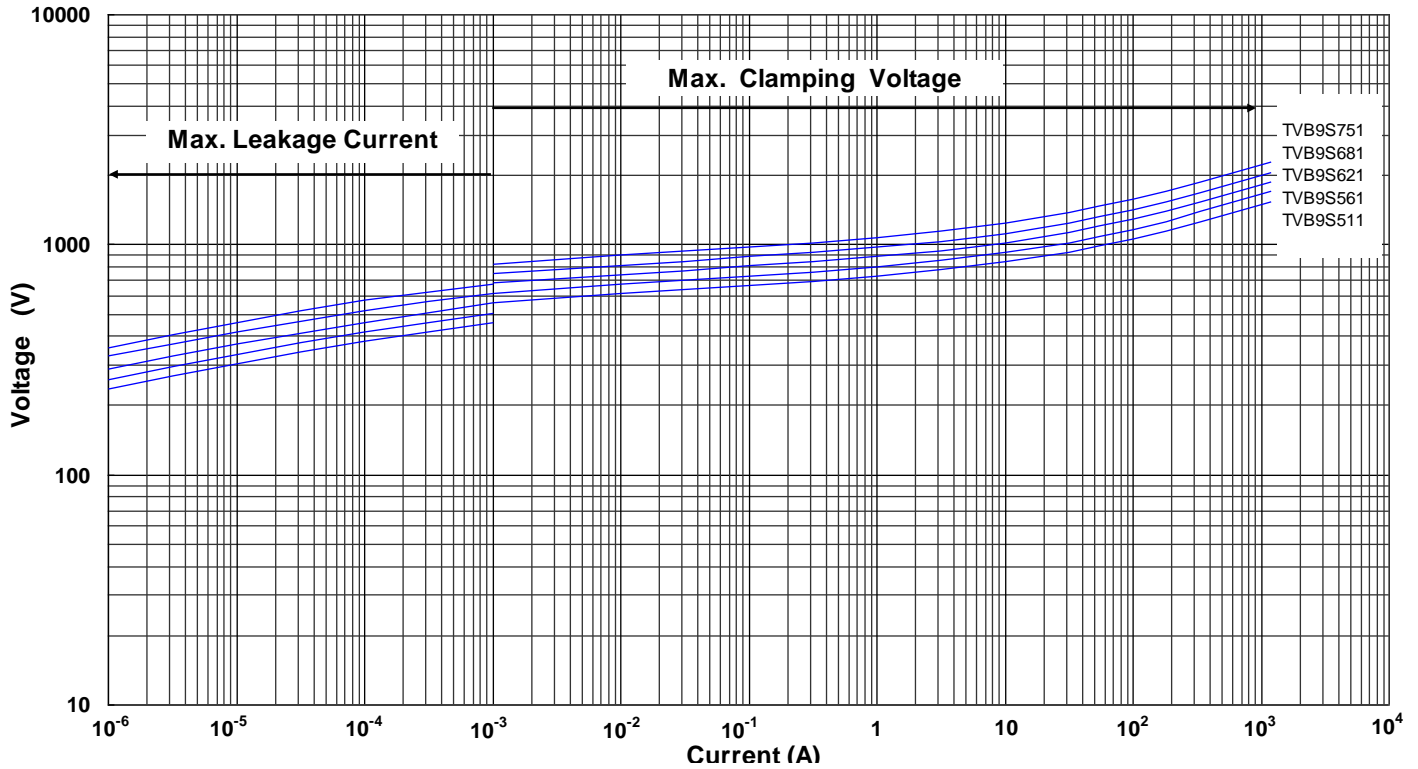

Max. Leakage Current and Max. Clamping Voltage Curves (TVBDS820 to TVBDS751)

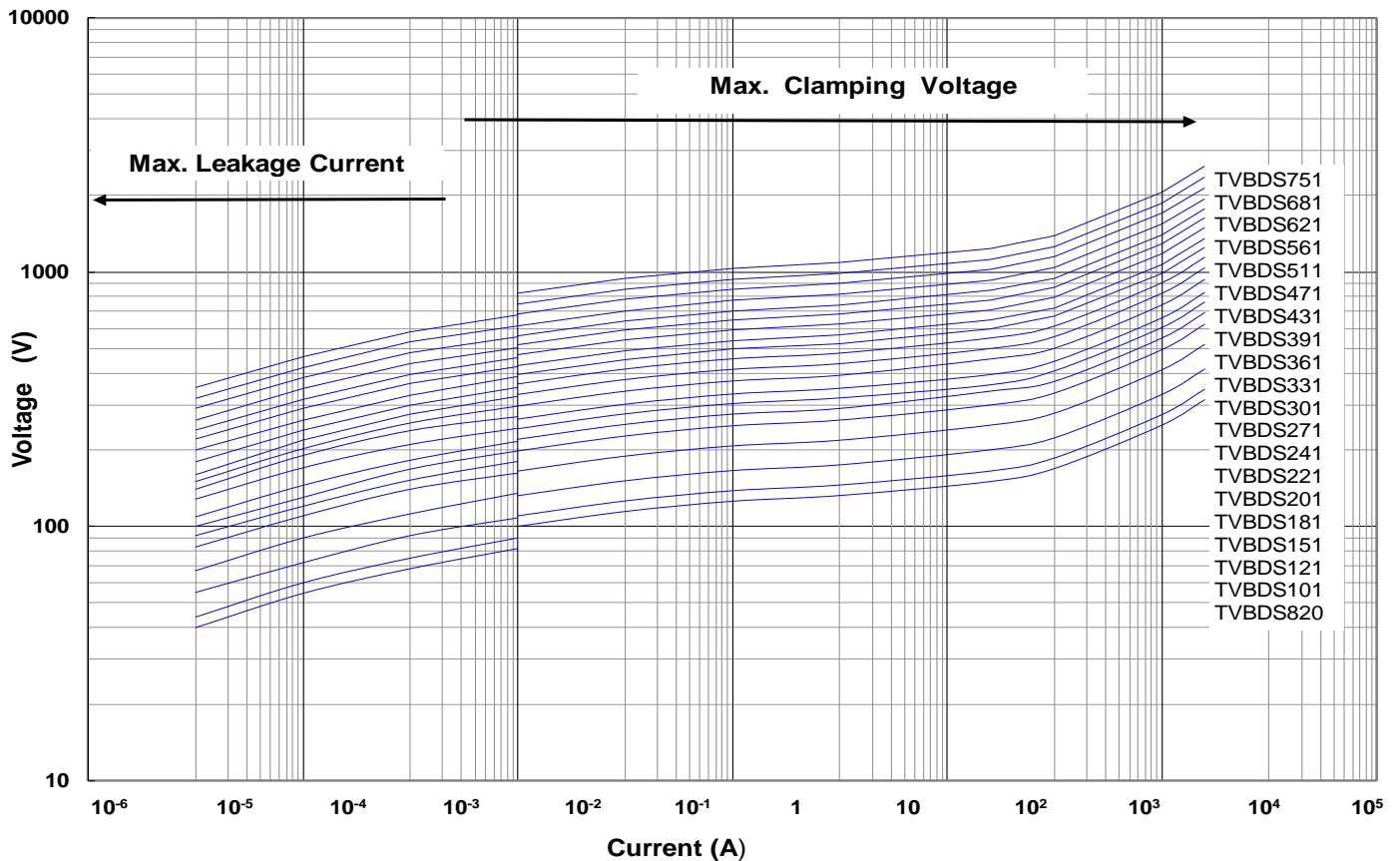



# Metal Oxide Varistor : TVB Series



## Plastic Encapsulated Type Varistor for Surge Protection

### ■ Max. Leakage Current and Max. Clamping Voltage Curves

Max. Leakage Current and Max. Clamping Voltage Curves (TVBES270 to TVBES680)

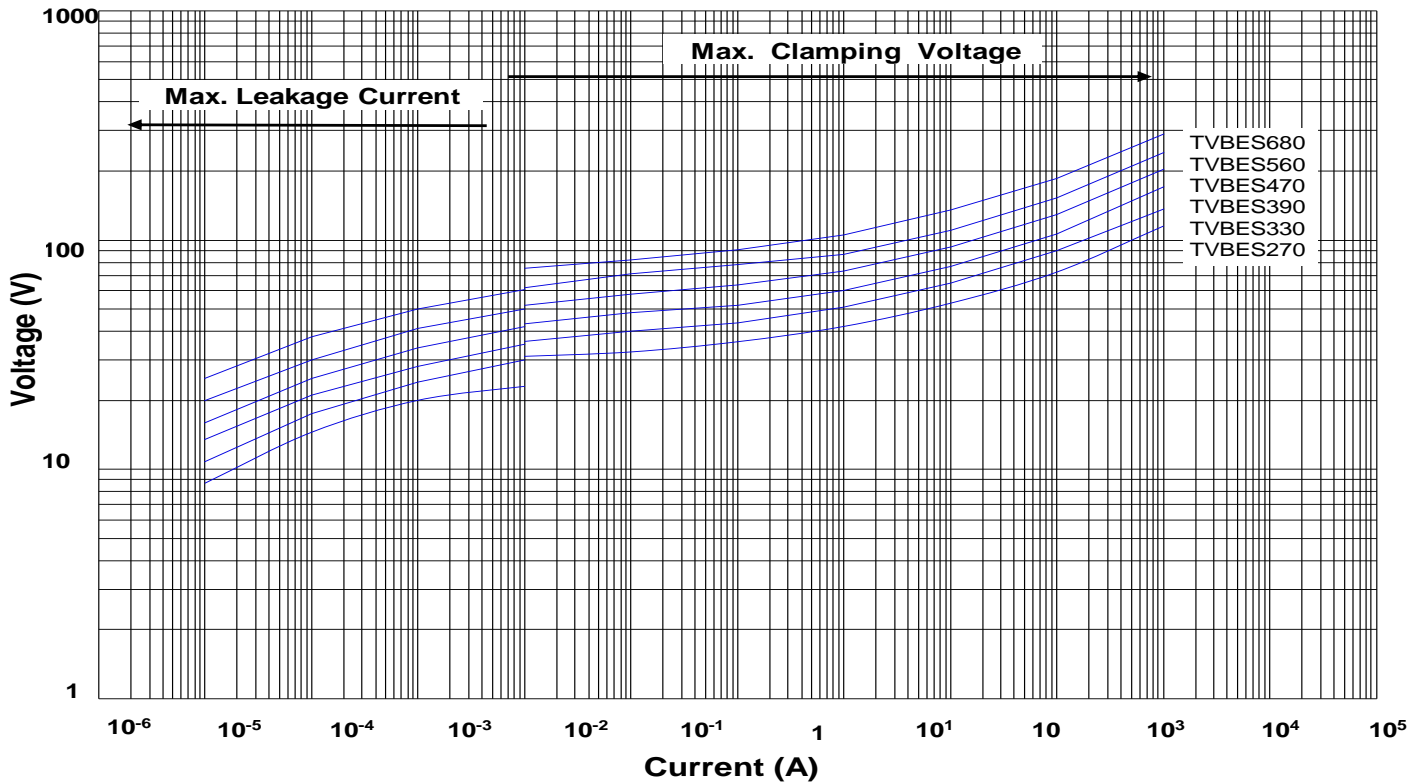

Max. Leakage Current and Max. Clamping Voltage Curves (TVBES820 to TVBES751)

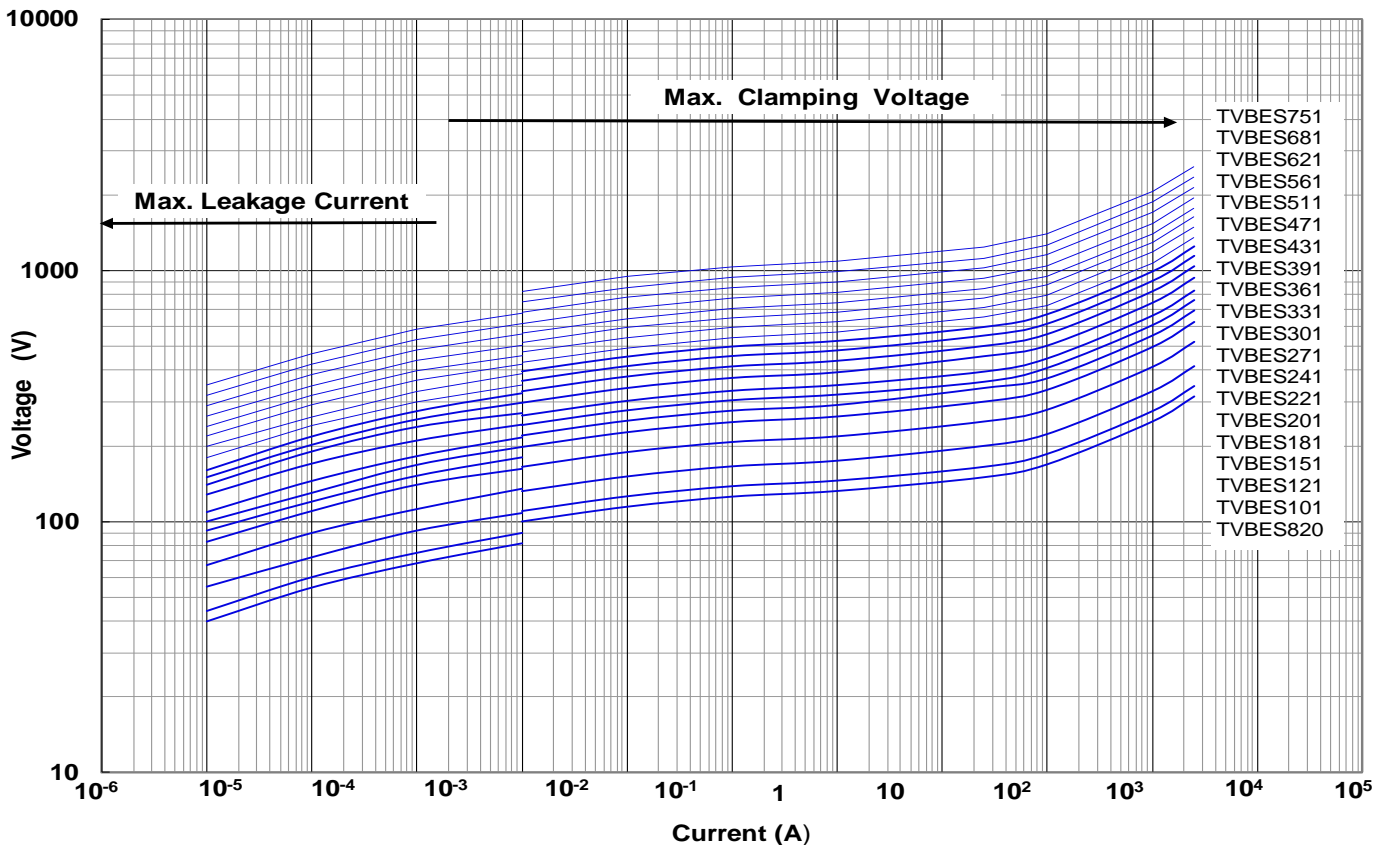



# Metal Oxide Varistor : TVB Series



## Plastic Encapsulated Type Varistor for Surge Protection

### ■ Soldering Recommendation

#### ● IR-reflow Soldering Profile

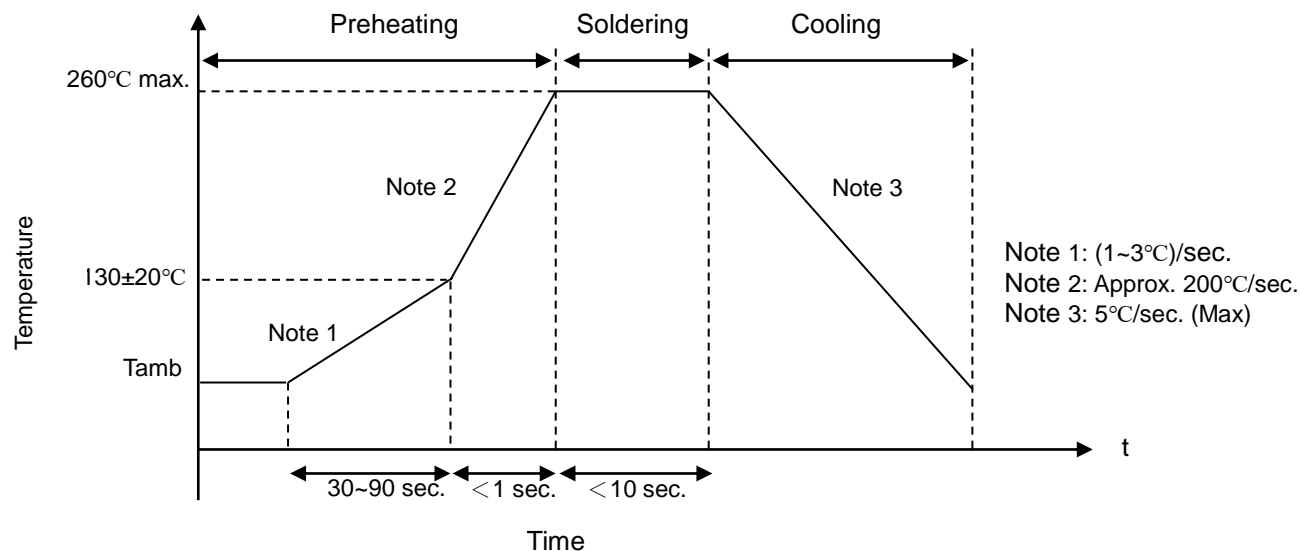

#### ● Recommended Reworking Conditions with Soldering Iron

Item	Conditions
Temperature of Soldering Iron-tip	360°C (max.)
Soldering Time	3 sec (max.)
Diameter of Soldering Iron-tip	Φ3 mm (max.)

# Metal Oxide Varistor : TVB Series



## Plastic Encapsulated Type Varistor for Surge Protection

### ■ Reliability

Item	Standard	Test conditions / Methods	Specifications															
Vibration	IEC 60068-2-6	Frequency range: 10~55Hz Amplitude: 0.75mm or 98m/s <sup>2</sup> Direction: 3 mutually perpendicular directions, 2 hrs each.	$ \Delta V_{1mA} / V_{1mA}  \leq \pm 5\%$ No visible damage															
Solderability	IEC 60068-2-20	245±3°C, 3±0.3 sec	At least 95% of terminal electrode is covered by new solder															
Resistance to Soldering Heat	IEC 60068-2-20	260±5°C TVB7S Series: 5±1 sec TVB9S/TVBDS/TVBES Series: 10±1 sec	$ \Delta V_{1mA} / V_{1mA}  \leq \pm 5\%$ No visible damage															
High Temperature Storage	IEC 60068-2-2	125±5°C x 1000 ±24 hrs	$ \Delta V_{1mA} / V_{1mA}  \leq \pm 5\%$ No visible damage															
Damp Heat, Steady State	IEC60068-2-78	a. 40±2°C, 90 ~ 95 % RH, 1344 hrs. b. 40±2°C, 90 ~ 95 % RH, at 10%Vdc, 1344 hrs	$ \Delta V_{1mA} / V_{1mA}  \leq \pm 5\%$ No visible damage Insulation Resistance ≥ 100MΩ															
Rapid Change of Temperature	IEC 60068-2-14	The conditions shown below shall be repeated 5 cycles <table border="1"> <thead> <tr> <th>Step</th> <th>Temperature (°C)</th> <th>Period (minutes)</th> </tr> </thead> <tbody> <tr> <td>1</td> <td>-40±3</td> <td>30±3</td> </tr> <tr> <td>2</td> <td>Room temperature</td> <td>5±3</td> </tr> <tr> <td>3</td> <td>TVB7S/TVB9S: +85±2 TVBDS/TVBES Series: +105±2</td> <td>30±3</td> </tr> <tr> <td>4</td> <td>Room temperature</td> <td>5±3</td> </tr> </tbody> </table>	Step	Temperature (°C)	Period (minutes)	1	-40±3	30±3	2	Room temperature	5±3	3	TVB7S/TVB9S: +85±2 TVBDS/TVBES Series: +105±2	30±3	4	Room temperature	5±3	$ \Delta V_{1mA} / V_{1mA}  \leq 5\%$ No visible damage
Step	Temperature (°C)	Period (minutes)																
1	-40±3	30±3																
2	Room temperature	5±3																
3	TVB7S/TVB9S: +85±2 TVBDS/TVBES Series: +105±2	30±3																
4	Room temperature	5±3																
High Temp. Load	MIL-STD-202 Method 108	TVB7S & TVB9S Series: 85°C TVBDS & TVB S Series: 105°C 1000±24 hrs at V <sub>DC</sub> or V <sub>rms</sub> (Max. Continuous Voltage)	$ \Delta V_{1mA} / V_{1mA}  \leq 10\%$ No visible damage															
8/20μs Surge Life	IEC 61051-1	8/20μs waveform, 10 surge currents, unipolar, interval 30 sec, amplitude corresponding to max. surge current derating curves for 20μs.	$ \Delta V_{1mA} / V_{1mA}  \leq \pm 10\%$ No visible damage															
10/1000μs Surge Life	IEC 61051-1	10/1000μs waveform, 10 surge currents, unipolar, interval 2 mins, amplitude corresponding to max. surge current derating curves for 1000μs.	$ \Delta V_{1mA} / V_{1mA}  \leq \pm 10\%$ No visible damage															
Voltage Proof	IEC 61051-1	Metal balls method, 2500 V <sub>ac</sub> 1 min	No visible damage															
Varistor Voltage Temp. Coefficient	Specification Standard	TVB7S & TVB9S Series: Varistor voltage is measured at -40°C, +85°C, and +25°C TVBDS & TVBES Series: Varistor voltage is measured at -40°C, +105°C, and +25°C	-0.05~0.05 %/°C															

# Metal Oxide Varistor : TVB Series



## Plastic Encapsulated Type Varistor for Surge Protection

### ■ Packaging

#### ● Taping Specification (TVB7S/TVB9S/TVBDS Series)

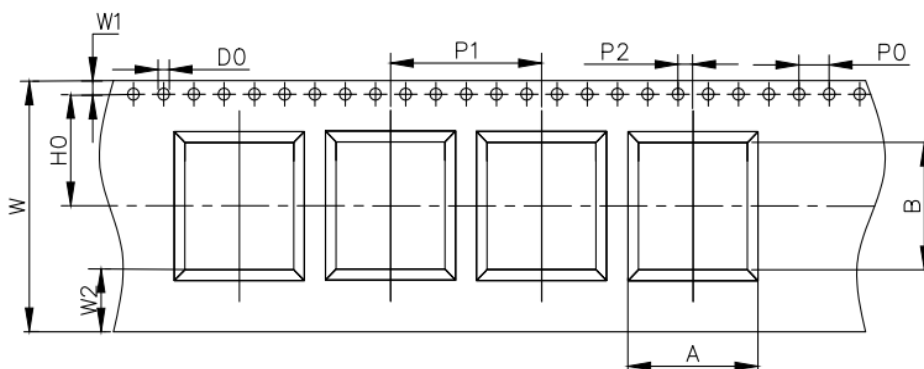

(Unit: mm)

Item	A*B	P <sub>0</sub>	P <sub>1</sub>	P <sub>2</sub>	H <sub>0</sub>	W	W <sub>1</sub>	W <sub>2</sub>	D <sub>0</sub>
<b>Tolerance</b>	<b>±0.2</b>	<b>±0.1</b>	<b>±0.1</b>	<b>±0.05</b>	<b>±0.05</b>	<b>±0.3</b>	<b>±0.1</b>	<b>Min.</b>	<b>+0.1/0</b>
Size	3225	7*8.7	4	12	2	7.5	16	1.75	1.5
	4032	8.6*10.6							
	5548	12.5*14.3	4	20	2	11.5	24	1.75	3.6

#### ● Taping Specification (TVBES Series)

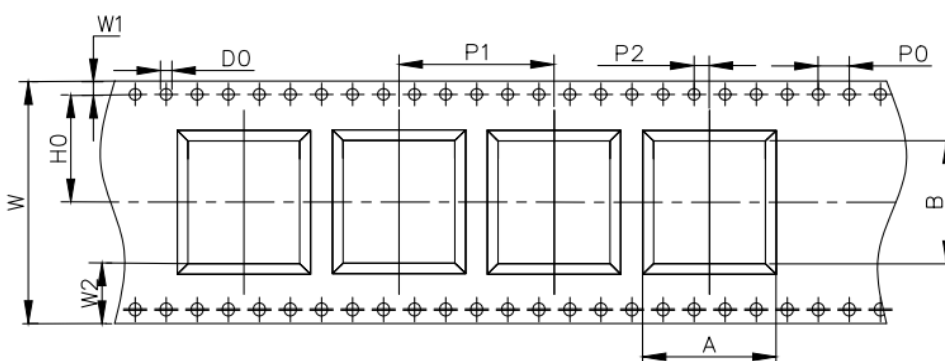

(Unit: mm)

Item	A*B	P <sub>0</sub>	P <sub>1</sub>	P <sub>2</sub>	H <sub>0</sub>	W	W <sub>1</sub>	W <sub>2</sub>	D <sub>0</sub>	
<b>Tolerance</b>	<b>±0.2</b>	<b>±0.1</b>	<b>±0.1</b>	<b>±0.05</b>	<b>±0.05</b>	<b>±0.3</b>	<b>±0.1</b>	<b>Min.</b>	<b>+0.1/0</b>	
Size	6255	14.7*16.4	4	20	2	14.2	32	1.75	7.9	1.5

# Metal Oxide Varistor : TVB Series



## Plastic Encapsulated Type Varistor for Surge Protection

- Quantity

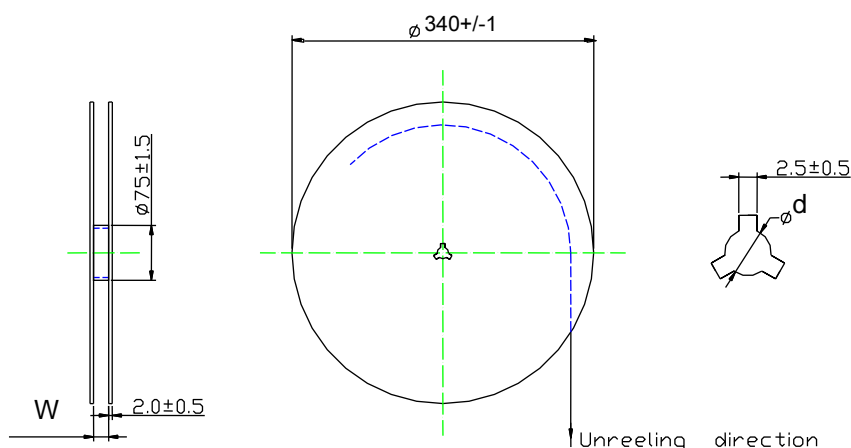

Size	Quantity (pcs/reel)	W	Φd
3225	1,000	17±0.5	12.5±1
4032	1,000	17±0.5	12.5±1
5548	500	25±1	13.5+1/-0.5
6255	500	33±1	13.5+1/-0.5

### ■ Warehouse Storage Conditions of Products

- Storage Conditions:
  1. Storage Temperature: -10°C ~ +40°C
  2. Relative Humidity: ≤ 75%RH
  3. Keep away from corrosive atmosphere and sunlight.
- Period of Storage: 1 year