

# Transient Voltage Suppression Diodes: P6SMB Series

## SMD Type 600 W



### ■ Features

1. Glass passivated chip
2. 600W peak pulse power capability at 10/1000μs waveform, repetition rate (duty cycle): 0.01%
3. Excellent clamping capability
4. Very fast response time
5. Low clamping voltage
6. Low leakage current
7. Meets MSL level 1, per J-STD-020, LF maximum peak of 260°C
8. JESD22-A114-B ESD Voltage: HBM 15KV
9. JEDEC EIA/JESD22-C101F ESD Voltage: CDM 500V
10. JEDEC EIA/JESD22-A115 ESD Voltage: MM 400V
11. ESD-immunity acc. IEC 61000-4-2 ±30kV(contact), ±30kV(air)
12. Halogen free and RoHS compliant

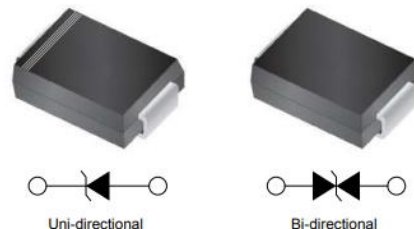

### ■ Recommended Applications

1. Computers
2. Telecom system
3. Industrial equipment
4. Consumer electronic applications
5. Other VCC bus and I/O interfaces

### ■ Mechanical Data

1. Case: Molded plastic, DO-214AA (SMB)
2. Epoxy: UL 94V-0 rate flame retardant
3. Terminals: Solderable per MIL-STD-750, method 2026
4. Polarity: Color band denotes cathode end
5. Mounting Position: Any

### ■ Part Number Code

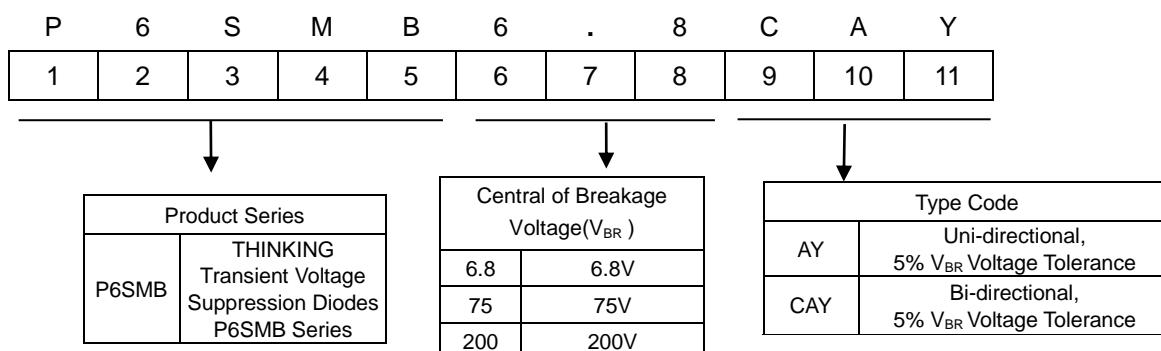

# Transient Voltage Suppression Diodes: P6SMB Series

## SMD Type 600 W



### Structures and Dimensions

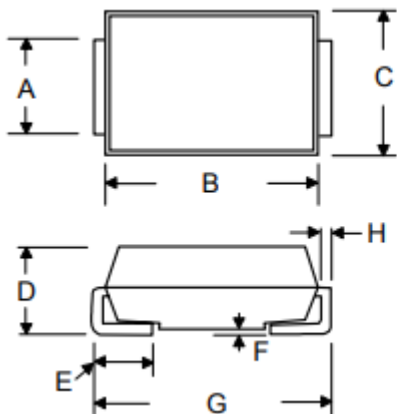

Symbol	Dimensions in millimeters	
	Min	Max
A	1.80	2.20
B	4.06	4.75
C	3.30	3.94
D	1.99	2.61
E	0.76	1.52
F	-	0.20
G	5.08	5.59
H	0.15	0.31

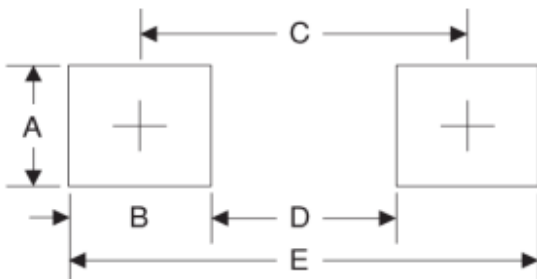

Symbol	Unit (mm)	Unit (inch)
A	2.30	0.091
B	2.00	0.078
C	4.10	0.161
D	2.10	0.083
E	6.10	0.240

### Maximum Rating ( $T_A=25^\circ\text{C}$ unless otherwise noted)

Parameter	Symbol	Value	Unit
Peak power dissipation with a 10/1000 $\mu\text{s}$ waveform (Note 1,2)	$P_{PPM}$	600	W
Peak pulse current with 10/1000 $\mu\text{s}$ waveform (Note 1)	$I_{PPM}$	See next table	A
Peak forward surge current, 8.3 ms single half sine-wave (Note 3)	$I_{FSM}$	100	A
Power dissipation on infinite heatsink at $T_L=75^\circ\text{C}$	$P_D$	5	W
Typical thermal resistance junction to ambient	$R_{\theta JA}$	100	$^\circ\text{C/W}$
Typical thermal resistance junction to lead	$R_{\theta JL}$	20	$^\circ\text{C/W}$
Operating junction and storage temperature range	$T_J, T_{STG}$	-55 to +150	$^\circ\text{C}$

Note:

1. Non-repetitive current pulse, per Fig. 3 and derated above  $T_A=25^\circ\text{C}$  per Fig. 2.
2. Mounted on 5.0 x 5.0mm copper pad to each terminal.
3. Measured on 8.3ms single half sine wave or equivalent square wave for unidirectional device only, duty cycle=4 per minute maximum.

# Transient Voltage Suppression Diodes: P6SMB Series

## SMD Type 600 W



### ■ Electrical Characteristics (T<sub>A</sub>=25°C unless otherwise noted)

Part No. (Uni)	Part No. (Bi)	Reverse Stand off Voltage V <sub>RWM</sub> ( V )	Breakage Voltage V <sub>BR</sub> @ I <sub>T</sub>		Test Current I <sub>T</sub> ( mA )	Maximum Clamping Voltage V <sub>C</sub> @ I <sub>pp</sub>	Maximum Peak Pulse Current I <sub>pp</sub> (A)	Maximum Reverse Leakage I <sub>R</sub> @V <sub>RWM</sub>	Marking Code	
			Min( V )	Max( V )					Uni	Bi
P6SMB6.8AY	P6SMB6.8CAY	5.8	6.45	7.14	10	10.5	57.1	1000	6V8A	6V8C
P6SMB7.5AY	P6SMB7.5CAY	6.4	7.13	7.88	10	11.3	53.1	500	7V5A	7V5C
P6SMB8.2AY	P6SMB8.2CAY	7.02	7.79	8.61	10	12.1	49.6	200	8V2A	8V2C
P6SMB9.1AY	P6SMB9.1CAY	7.78	8.65	9.55	1	13.4	44.8	50	9V1A	9V1C
P6SMB10AY	P6SMB10CAY	8.55	9.5	10.5	1	14.5	41.4	10	10A	10C
P6SMB11AY	P6SMB11CAY	9.4	10.5	11.6	1	15.6	38.5	5	11A	11C
P6SMB12AY	P6SMB12CAY	10.2	11.4	12.6	1	16.7	35.9	5	12A	12C
P6SMB13AY	P6SMB13CAY	11.1	12.4	13.7	1	18.2	33	5	13A	13C
P6SMB15AY	P6SMB15CAY	12.8	14.3	15.8	1	21.2	28.3	1	15A	15C
P6SMB16AY	P6SMB16CAY	13.6	15.2	16.8	1	22.5	36.7	1	16A	16C
P6SMB18AY	P6SMB18CAY	15.3	17.1	18.9	1	25.2	23.8	1	18A	18C
P6SMB20AY	P6SMB20CAY	17.1	19	21	1	27.7	21.7	1	20A	20C
P6SMB22AY	P6SMB22CAY	18.8	20.9	23.1	1	30.6	19.6	1	22A	22C
P6SMB24AY	P6SMB24CAY	20.5	22.8	25.2	1	33.2	18.1	1	24A	24C
P6SMB27AY	P6SMB27CAY	23.1	25.7	28.4	1	37.5	16	1	27A	27C
P6SMB30AY	P6SMB30CAY	25.6	28.5	31.5	1	41.4	14.5	1	30A	30C
P6SMB33AY	P6SMB33CAY	28.2	31.4	34.7	1	45.7	13.1	1	33A	33C
P6SMB36AY	P6SMB36CAY	30.8	34.2	37.8	1	49.9	12	1	36A	36C
P6SMB39AY	P6SMB39CAY	33.3	37.1	41	1	53.9	11.1	1	39A	39C
P6SMB43AY	P6SMB43CAY	36.8	40.9	45.2	1	59.3	10.1	1	43A	43C
P6SMB47AY	P6SMB47CAY	40.2	44.7	49.4	1	64.8	9.3	1	47A	47C
P6SMB51AY	P6SMB51CAY	43.6	48.5	53.6	1	70.1	8.6	1	51A	51C
P6SMB56AY	P6SMB56CAY	47.8	53.2	58.8	1	77	7.8	1	56A	56C
P6SMB62AY	P6SMB62CAY	53	58.9	65.1	1	85	7.1	1	62A	62C
P6SMB68AY	P6SMB68CAY	58.1	64.6	71.4	1	92	6.5	1	68A	68C
P6SMB75AY	P6SMB75CAY	64.1	71.3	78.8	1	103	5.8	1	75A	75C
P6SMB82AY	P6SMB82CAY	70.1	77.9	86.1	1	113	5.3	1	82A	82C
P6SMB91AY	P6SMB91CAY	77.8	86.5	95.5	1	125	4.8	1	91A	91C
P6SMB100AY	P6SMB100CAY	85.5	95	105	1	137	4.4	1	100A	100C

# Transient Voltage Suppression Diodes: P6SMB Series

## SMD Type 600 W



### ■ Electrical Characteristics (T<sub>A</sub>=25°C unless otherwise noted)

Part No. (Uni)	Part No. (Bi)	Reverse Stand off Voltage V <sub>RWM</sub> ( V )	Breakage Voltage V <sub>BR</sub> @ I <sub>T</sub>		Test Current I <sub>T</sub> ( mA )	Maximum Clamping Voltage V <sub>C</sub> @ I <sub>pp</sub> V <sub>C</sub> ( V )	Maximum Peak Pulse Current I <sub>pp</sub> (A)	Maximum Reverse Leakage I <sub>R</sub> @ V <sub>RWM</sub> I <sub>R</sub> (μA)	Marking Code	
			Min( V )	Max( V )					Uni	Bi
P6SMB110AY	P6SMB110CAY	94	105	116	1	152	3.9	1	110A	110C
P6SMB120AY	P6SMB120CAY	102	114	126	1	165	3.6	1	120A	120C
P6SMB130AY	P6SMB130CAY	111	124	137	1	179	3.4	1	130A	130C
P6SMB150AY	P6SMB150CAY	128	143	158	1	207	2.9	1	150A	150C
P6SMB160AY	P6SMB160CAY	136	152	168	1	219	2.7	1	160A	160C
P6SMB170AY	P6SMB170CAY	145	162	179	1	234	2.6	1	170A	170C
P6SMB180AY	P6SMB180CAY	154	171	189	1	246	2.4	1	180A	180C
P6SMB200AY	P6SMB200CAY	171	190	210	1	274	2.2	1	200A	200C
P6SMB220AY	P6SMB220CAY	185	209	231	1	328	1.9	1	220A	220C
P6SMB250AY	P6SMB250CAY	214	237	263	1	344	1.8	1	250A	250C
P6SMB300AY	P6SMB300CAY	256	285	315	1	414	1.5	1	300A	300C
P6SMB350AY	P6SMB350CAY	300	332	368	1	482	1.3	1	350A	350C
P6SMB400AY	P6SMB400CAY	342	380	420	1	548	1.1	1	400A	400C
P6SMB440AY	P6SMB440CAY	376	418	462	1	602	1	1	440A	440C
P6SMB480AY	P6SMB480CAY	408	456	504	1	658	0.9	1	480A	480C
P6SMB510AY	P6SMB510CAY	434	485	535	1	698	0.9	1	510A	510C
P6SMB530AY	P6SMB530CAY	451	503.5	556.5	1	725	0.8	1	530A	530C
P6SMB540AY	P6SMB540CAY	460	513	567	1	740	0.8	1	540A	540C
P6SMB550AY	P6SMB550CAY	468	522.5	577.5	1	760	0.8	1	550A	550C

# Transient Voltage Suppression Diodes: P6SMB Series

## SMD Type 600 W



### ■ Typical Characteristics ( $T_A=25^\circ\text{C}$ unless otherwise noted)

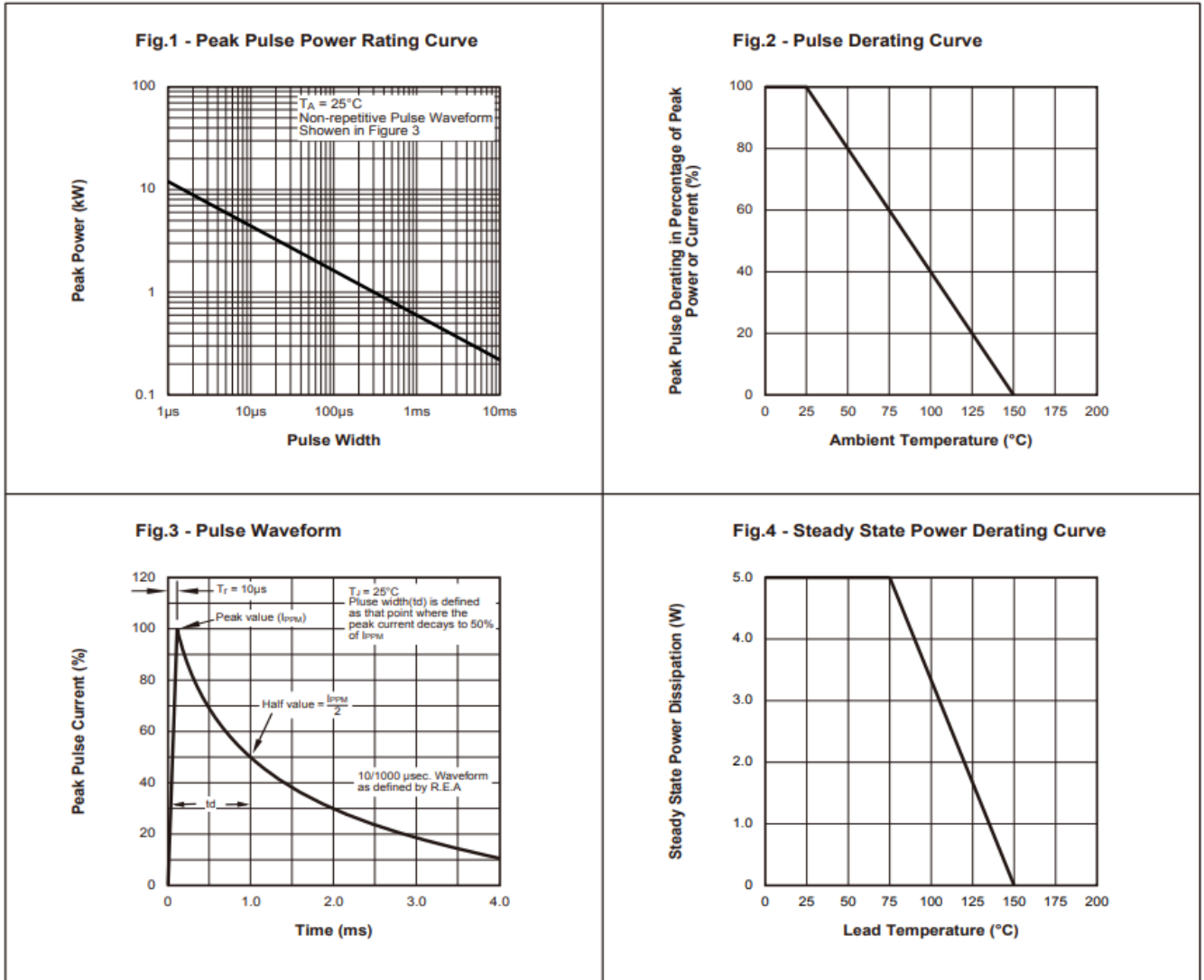

# Transient Voltage Suppression Diodes: P6SMB Series

## SMD Type 600 W



### ■ Soldering Recommendation

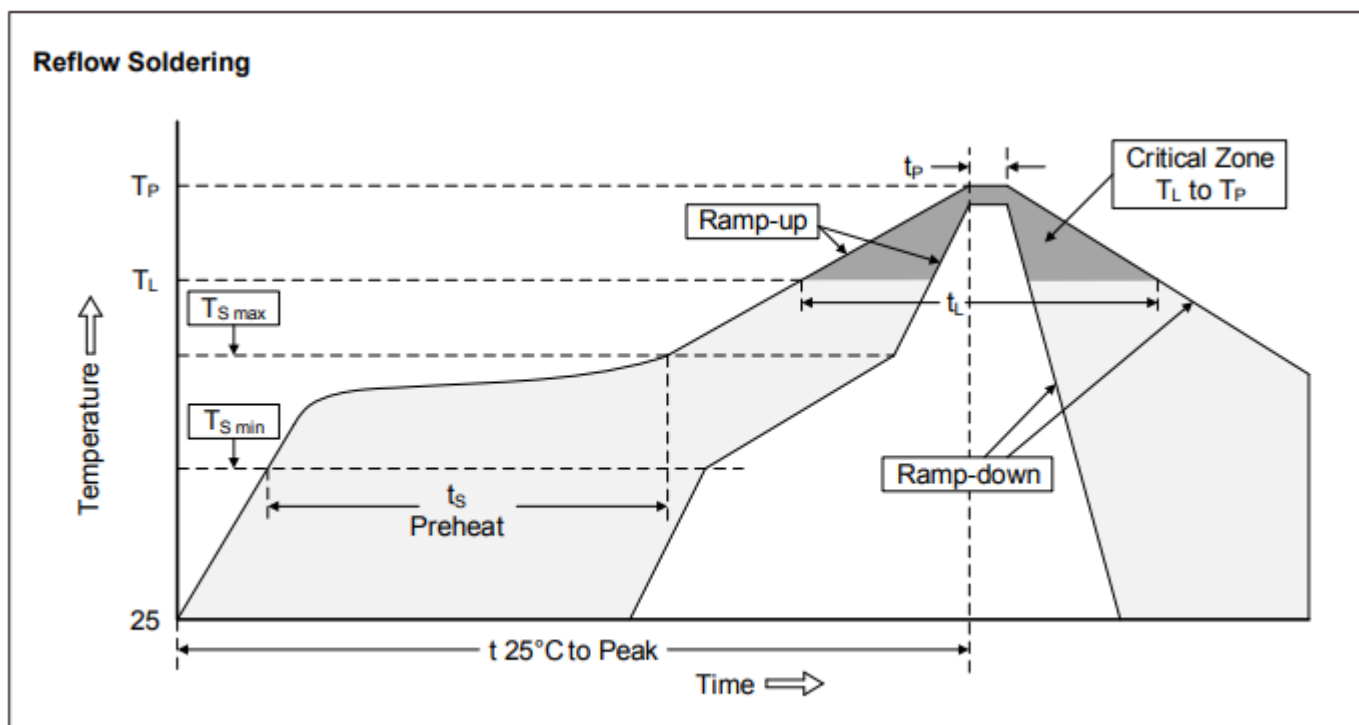

### Recommended Conditions

Profile Feature	Pb-Free Assembly
Average ramp-up rate ( $T_L$ to $T_P$ )	3°C/second max.
Preheat -Temperature Min ( $T_{S\ min}$ ) -Temperature Max ( $T_{S\ max}$ ) -Time (min to max) ( $t_s$ )	150°C 200°C 60-180 seconds
$T_{S\ max}$ to $T_L$ -Ramp-up Rate	3°C/second max.
Time maintained above: -Temperature ( $T_L$ ) -Time ( $t_L$ )	217°C 60-150 seconds
Peak Temperature ( $T_P$ )	260°C
Time within 5°C of actual Peak Temperature ( $t_p$ )	20-40 seconds
Ramp-down Rate	6°C/second max.
Time 25°C to Peak Temperature	8 minutes max.

# Transient Voltage Suppression Diodes: P6SMB Series

## SMD Type 600 W



### ■ Packaging

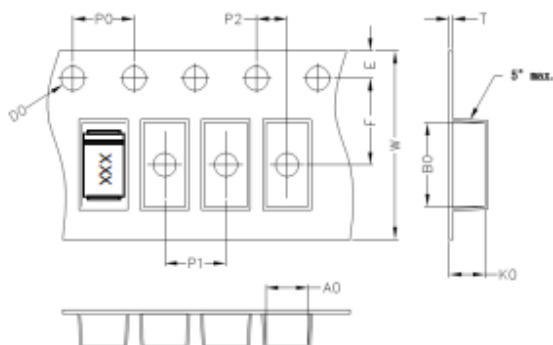

A0	B0	K0	D0	E	F
3.80	5.40	2.45	1.55	1.75	5.50
P0	P1	P2	T	W	Tolerance
4.0	8.0	2.0	0.25	12	0.1

### ■ Quantity

Series Type	Packaging option	Base quantity	Packaging specification
P6SMB	Tape and reel	3000pcs / reel	EIA STD RS-481

### ■ Warehouse Storage Conditions of product

- Storage Condition:
  1. Storage Temperature: -10°C~+40°C
  2. Relative Humidity:  $\leq 75\%RH$
  3. Keep away from corrosive atmosphere and sunlight.
- Period of Storage: 1 year.