

### Features

- 350Watts peak pulse power ( $T_P = 8/20\mu s$ )
- Tiny SOT-23 package
- Unidirectional configurations
- Protects two I/O port
- Low clamping voltage
- Low Leakage current
- ESD-immunity acc. IEC 61000-4-2  $\pm 30kV$  contact  $\pm 30kV$  air
- IEC 61000-4-4 (EFT) 40A (5/50ns)
- IEC 61000-4-5 (Lightning) 10A (8/20 $\mu s$ )

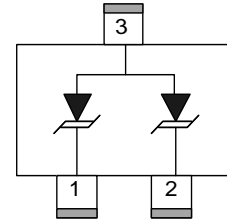
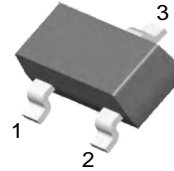

### Mechanical Data

- **Case:** SOT-23 (plastic package).  
Lead free; RoHS compliant; Halogen free
- **Molding Compound Flammability Rating:**  
UL 94 V-0
- **Terminals:** High temperature soldering guaranteed:  
260 °C/10 sec. at terminals

### Applications

- Cellular Handsets and Accessories
- RS-232, RS-422 & RS-485
- Control & Monitoring Systems
- Set-Top Box
- Portable Electronics
- Other electronics equipments Communication systems

### Absolute Maximum Ratings

Ratings at 25 °C, ambient temperature unless otherwise specified

Parameter	Symbol	Value	Unit
Peak Pulse Power ( $T_P=8/20\mu s$ )	$P_{PP}$	350	W
ESD contact/air discharge (IEC-61000-4-2)	$V_{ESD}$	30/30	kV
Peak Pulse Current ( $T_P = 8/20\mu s$ )	$I_{PP}$	10	A
Junction Temperature	$T_J$	-55 to +125	°C
Storage temperature	$T_{STG}$	-55 to +150	°C

### Electrical Characteristics

( $T_A = 25\text{ °C}$  unless otherwise specified)

Parameter	Symbol	Condition	Min	Typ	Max	Unit
Reverse stand-off Voltage	$V_{RWM}$				15	V
Reverse Breakdown Voltage	$V_{BR}$	$I_T=1mA$	16.7			V
Reverse Leakage Current	$I_R$	$V_{RWM}=15V$			0.5	$\mu A$
Clamping Voltage (IEC 61000-4-5)	$V_C$	$I_{PP}=10A$		35		V
Junction Capacitance	$C_J$	$V_R=0V, f=1MHz$		25		pF

**Typical Characteristics** ( $T_{amb} = 25\text{ }^{\circ}\text{C}$  unless otherwise specified)

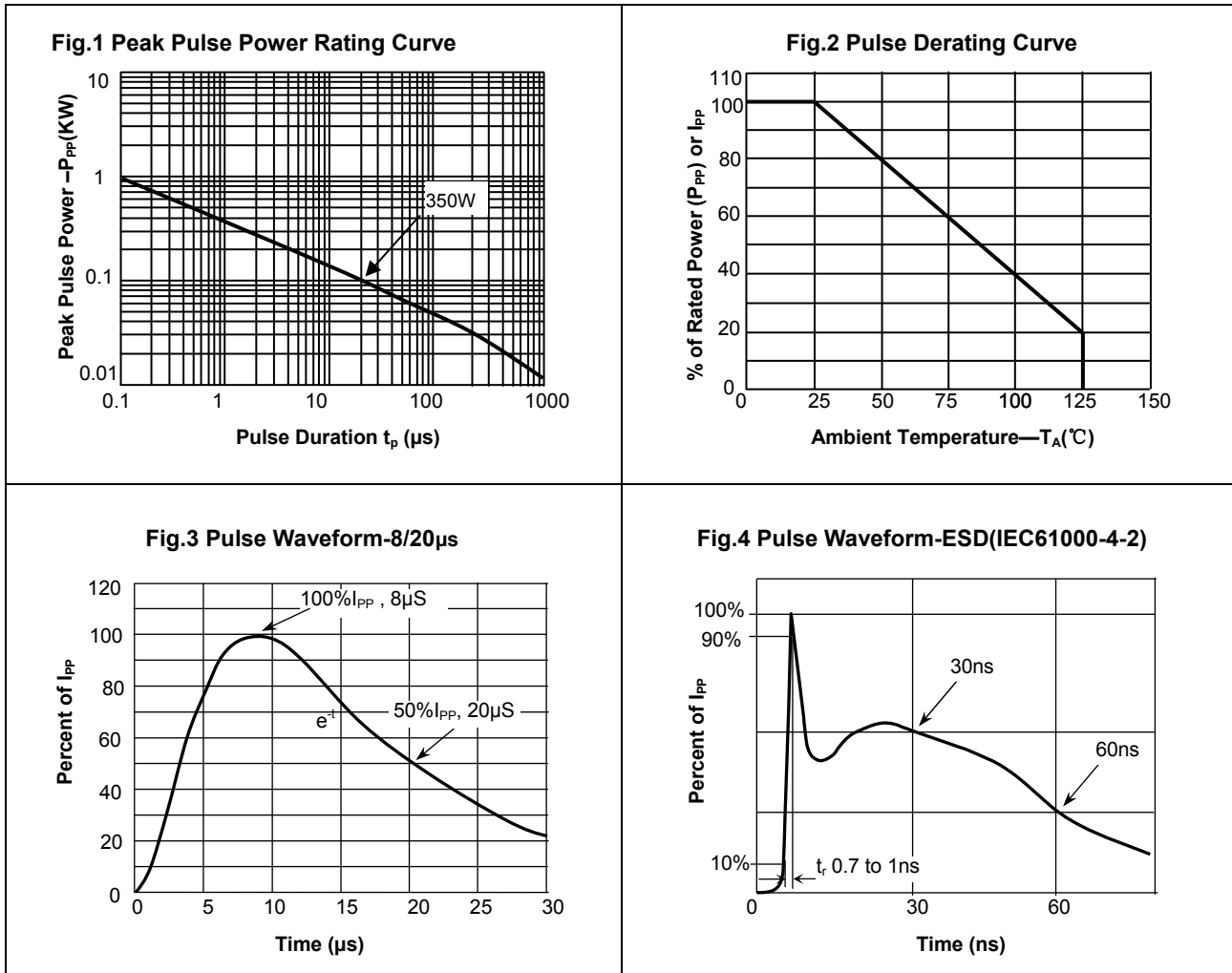

**Package Dimensions**

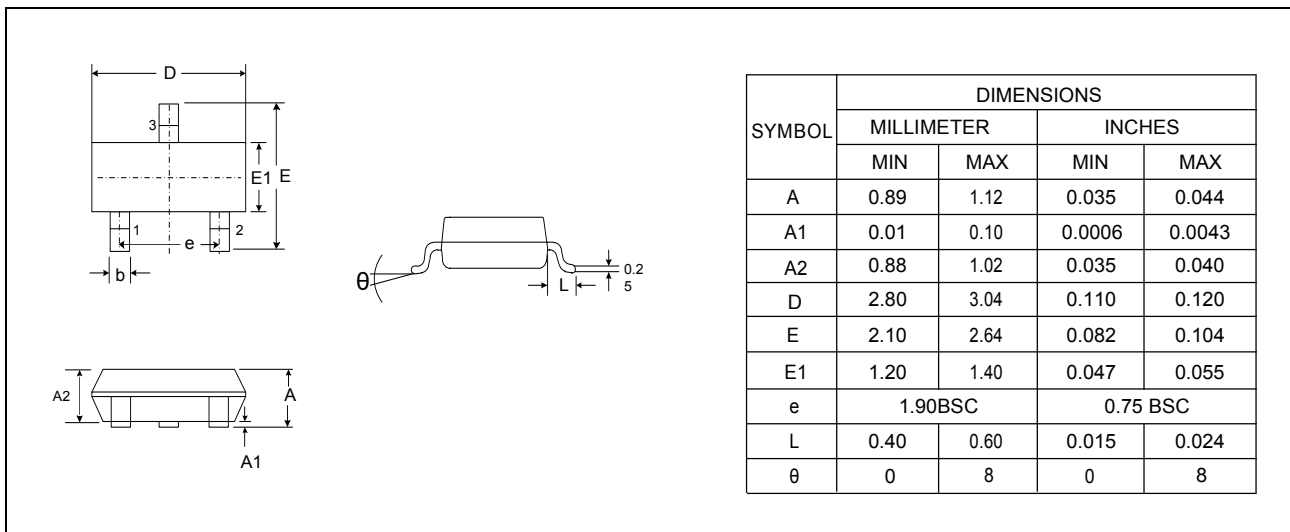

### Pad Dimensions

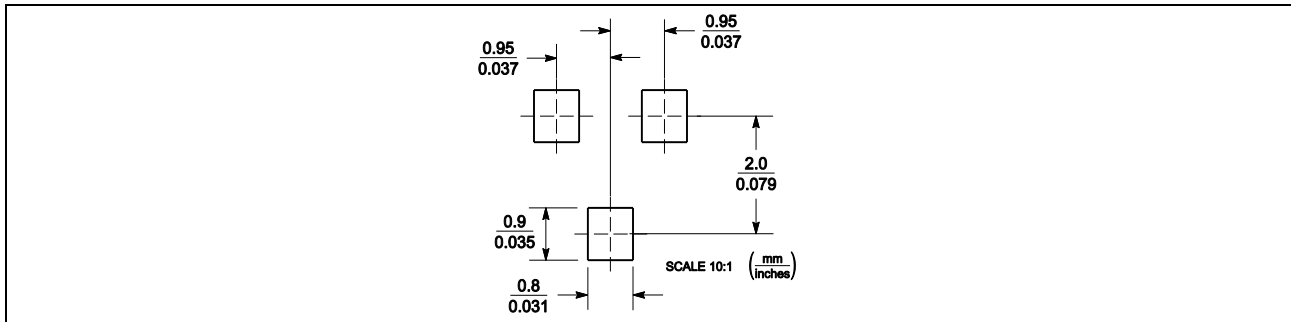

### Package Information

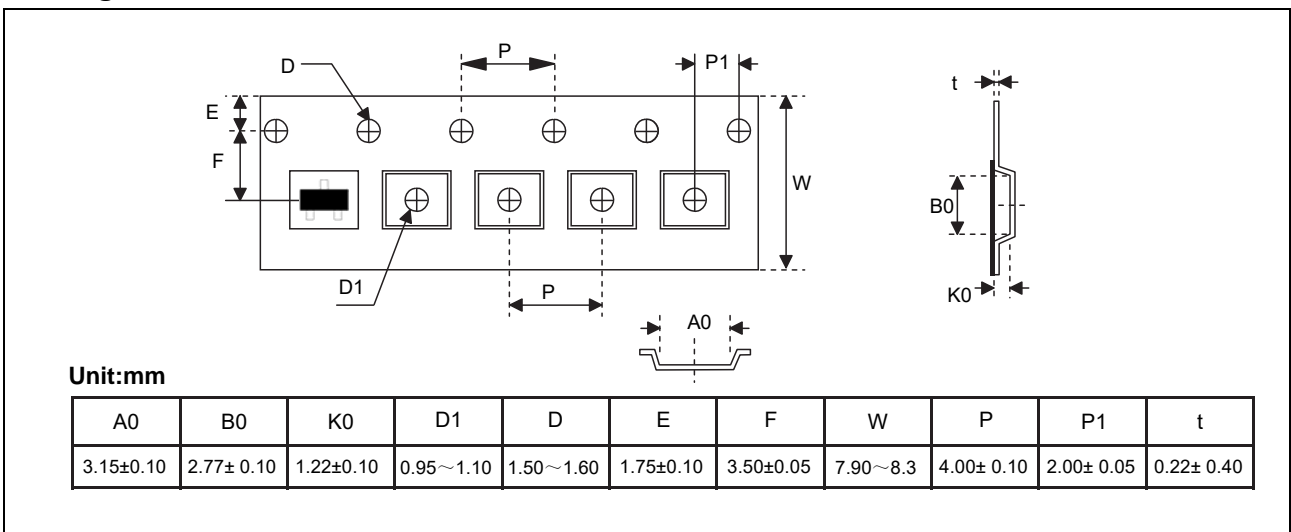

### Marking

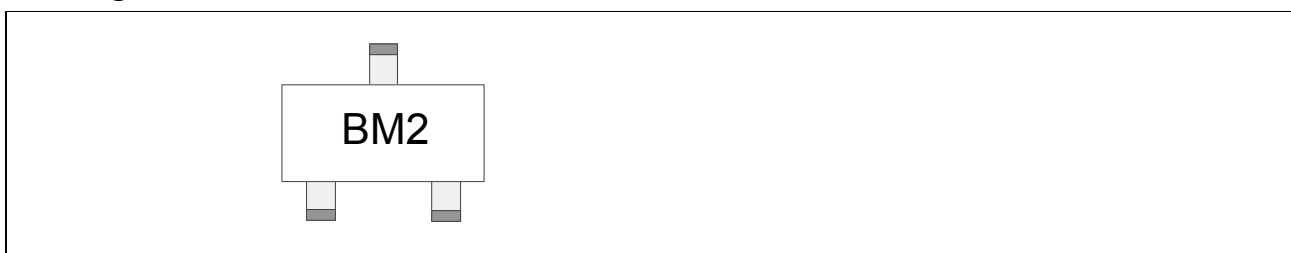

### Ordering information

Order code	Package	Packaging option	Base quantity	Packaging specification
YEDST231510AV	SOT-23	Tape and reel	3000pcs / reel	EIA STD RS-481