



承 认 书

APPROVAL SHEET

编号 No.	KSD1103100-A/3-B
日期 Date	2020.06.01

客 户 Customer	
-----------------	--

品 名 Product	Thermal Protector
系 列 Series	KSD05

料号 Part No.	规格描述 Specification	备注 Remark
贝特电子 Betterfuse		
客 户 Customer		

环保特别提示 Special instructions for environmental protection

本产品:

供应商-贝特电子 Supplier-Betterfuse	零件承认章 Approval Signet	客 户 Customer	零件承认章 Approval Signet
制 作 Make			
审 核 Check			
确 认 Approval			

联络 Contact

业务 Sales	电话 Telephone	手机 Cellphone	邮箱 E-mail

零件承认后敬请回签一份给我司留存, 或将承认后的封面传真(0769-8352 1857)至我司, 谢谢!



Document Record						
No.	Date	Modified Content	Page	Edition	Prepared/modified by	Checked by
1	2018.03.19	Draft		A/0	J.Q.	Faqing Lin
2	2018.11.05	Update UL certification	8	A/1	Xiang Xiong	Faqing Lin
3	2019.03.29	Add CQC certification	8	A/2	Xiang Xiong	Faqing Lin
4	2020.06.01	Add KC certification		A/3	YaLan Wang	Faqing Lin
5						
6						
7						
8						
9						
10						
11						

TABLE OF CONTENTS

1. COPE AND DESCRIPTION.....	3
2. GENERAL INFORMATION.....	3
3. AGENCY APPROVALS.....	3
4. PART NUMBERING SYSTEM.....	4
5. STRUCTURE.....	5
6. ELECTRICAL CHARACTERISTICS.....	5
7. TEMPERATURE CHARACTERISTIC.....	6
8. ORDERING INFORMATION.....	6
9. PACKING INFORMATION.....	7
10. APPENDIX.....	7



1. SCOPE AND DESCRIPTION

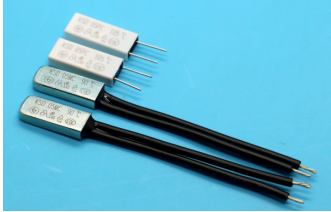

The product for the KSD series thermal protector. Mainly as electrical appliances overheating or over temperature protection function.

KSD series thermal protector, widely used, mainly used in electric motors, pumps, lamps and lanterns, transformer, fan and related temperature overheat or over temperature protection appliance.

2. GENERAL INFORMATION

General Description

Function: KSD thermal protector is through the bimetallic strip feel the change of temperature jump off action, and then cut off the circuit. The circuit of overheat or over temperature protection.

Construction: It is mainly composed of three major components: bimetallic strip action mechanism, the shell and the power cord..







Characteristics:

KSD thermal protection appliance inductive temperature sensitive, quick, small volume, easy to install, the advantages of widely used in temperature related instruments, used as the over temperature protection or overheating protection.

Detailed Features

- Operating Temperature: 60°C~150°C
- Tolerance: ±5°C
- Temperature difference between operated and resetable temperature : 15°C~50°C
- Endurance: 10, 000 cycles
- Resistance between contacts < 50mΩ
- Hi-pot test: 1500VAC 0.5mA 1min
- Insulation resistance: >5MΩ

3. AGENCY APPROVALS

Approval	Certification NO.	Rate Voltage / Ampere	Certification category
	E215779	250VAC 5A DC24V 10A 115VAC 8A	Thermal Motor Protector
	E468091	120VAC 8A 277VAC 5A 24VDC 8A 10,000cycle	Thermostat
	CQC14002119169	250VAC 5A DC24V 10A (P)	Thermal Motor Protector
	CQC14002119582	250VAC 5A DC24V 10A (M)	
	CQC19002215328	250VAC 5A 50Hz or 60Hz , DC24V 8A (P) 10,000cycle	Thermostat
	CQC19002215329	250VAC 5A 50Hz or 60Hz , DC24V 8A (M) 10,000cycle	
	R 50289642	250VAC 5A DC24V 10A	Thermal Motor Protector



	R 50427761	250VAC 5A 50Hz or 60Hz , DC24V 8A 10,000cycle	Thermostat
CB	CN31084	250VAC 5A DC24V 10A (P)	Thermal Motor Protector
CB	CN31082	250VAC 5A DC24V 10A (M)	
	ZU02109-19001	250VAC 5A (M) 10,000cycle	Thermal cut out
	ZU02109-19002	250VAC 5A (P) 10,000cycle	

4. PART NUMBERING SYSTEM

4.1 Part Number

Example: KSD1103100

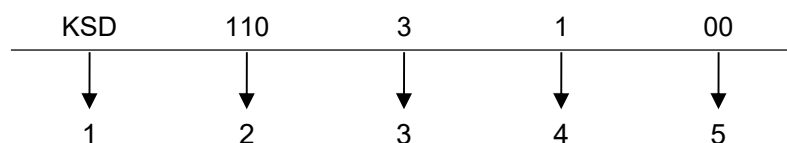

- 1Product Series..... KSD
- 2Operating Temperature..... 110°C (See table 4.2)
- 3Casing material..... small plastic (See table 4.3)
- 4Type of operating..... 0: Open 1: Close
- 5Supplementary Code..... 00-99
(Or alphanumeric)

4.2 Operating Temperature Table

TEMPERATURE CODE	OPERATING TEMPERATURE
060	60°C
065	65°C
070	70°C
075	75°C
080	80°C
085	85°C
090	90°C
095	95°C
100	100°C
105	105°C
110	110°C
115	115°C
120	120°C
125	125°C
130	130°C
135	135°C
140	140°C
145	145°C
150	150°C

4.3 Casing Material Code Table

CODE	DESCRIPTION
0	Big metal (20X7.4X3.8)
1	Big plastic (20X7.9X4.2)
2	Small metal (15X7.0X3.2)
3	Small plastic (15X7.1X3.5)----Normal Close Small plastic (16X7.2X3.8)----Normal Open
7	Thickened metal (16.7X7.6X3.8)



4.4 Printing instructions

Marking:



Marking Instructions:

first line:

KSD:Product series

05: Product model

P: Shell material (P-plastic shell M-metal shell)

C: Action state (C-normally closed O-normally open)

115°C:Product action temperature

Second line:

 :Company Logo

   :Certification symbol

Note:There is no marking in the other location of the product except

this position



Normal Close

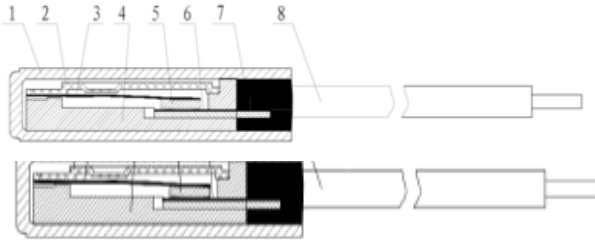

- 1. Plastic casing 2. Plate 3. Bi-metal
- 4. Bottom 5. Contact 6. Ag-plate
- 7. AB insulation paste 8. wire

KSD Series structure(metal casing)

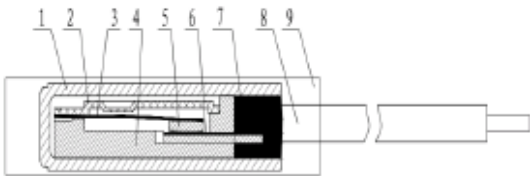

- 1. Metal casing 2. Plate 3. Bi-metal
- 4. Bottom 5. Contact 6. Ag-plate
- 7. AB insulation paste 8. Wire 9. Tube

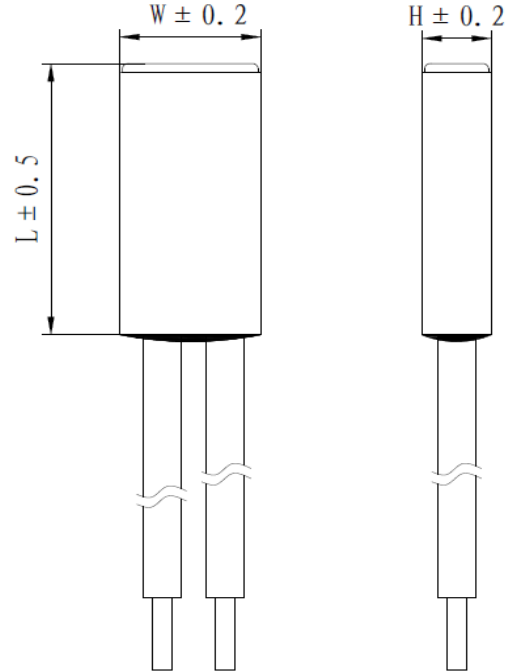

Dimensions (units in mm)

Normal Open(Plastic shell)

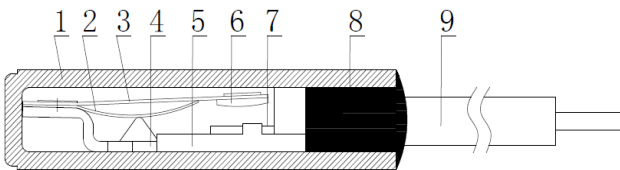

- 1. Plastic casing 2. Bi-metal 3. Movable Arm
- 4. Plate 5. Bottom 6. Movable Contact
- 7. Ag-plate 8. Epoxy 9. Wire

Parameter:

- 1. Operating: 60°C ~ 150°C
- 2. Tolerance: ±5°C
- 3. Temperature difference between operated and resetable temperature : 15°C ~ 50°C
- 4. Shell size:
 - A、L X W X H=20*7.4*3.8(metal normal size)--Normal Close
 - B、L X W X H=20*7.9*4.2(plastic normal size)--Normal Close
 - C、L X W X H=15*7.0*3.2(metal small size)--Normal Close
 - D、L X W X H=15*7.1*3.5(plastic small size)--Normal Close
 - E、L X W X H=16*7.2*3.8(plastic small size)--Normal Open
- 5. Shell material: customizable
- 6. Wire length and diameter: customizable
- 7. Reset reference, customizable

6. ELECTRICAL CHARACTERISTICS

Rated parameter: AC250V 5A, AC115V 8A, DC24V 10A

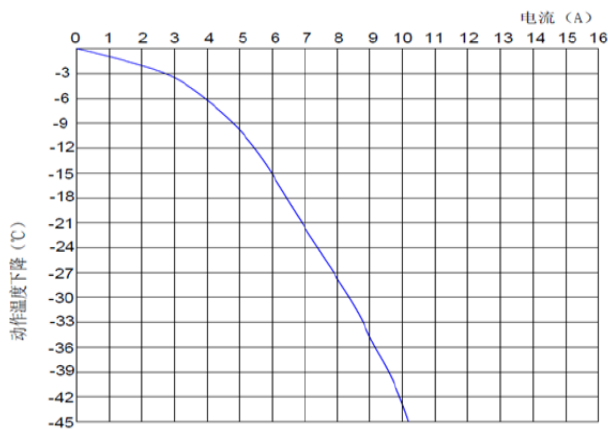

Open Temp.Drop due to Current

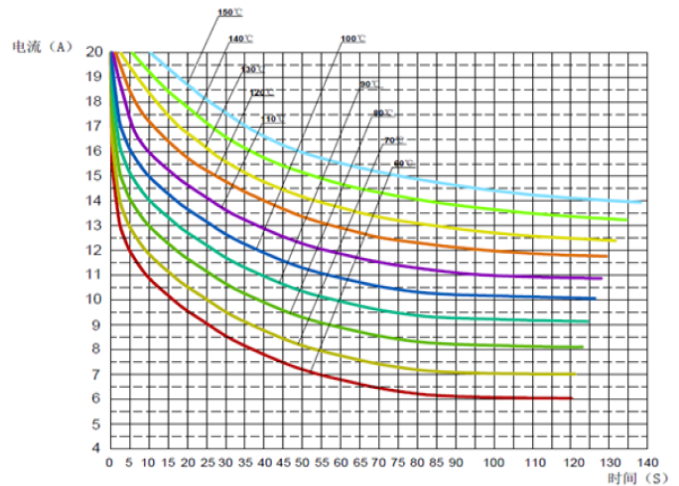

Current vs. Tripping time

7. TEMPERATURE CHARACTERISTIC

Temperature Characteristics

Model	Operating Temperature(°C)	Reset Temperature(°C)	Approval				
			TUV	UL	CQC	KC	CB
			250V	250V	250V	250V	250V
KSD060****	60±5	45±8	•	•	•	•	•
KSD065****	65±5	48±10	•	•	•	•	•
KSD070****	70±5	50±12	•	•	•	•	•
KSD075****	75±5	53±15	•	•	•	•	•
KSD080****	80±5	55±15	•	•	•	•	•
KSD085****	85±5	60±15	•	•	•	•	•
KSD090****	90±5	60±15	•	•	•	•	•
KSD095****	95±5	65±15	•	•	•	•	•
KSD100****	100±5	70±15	•	•	•	•	•
KSD105****	105±5	75±15	•	•	•	•	•
KSD110****	110±5	75±15	•	•	•	•	•
KSD115****	115±5	80±15	•	•	•	•	•
KSD120****	120±5	85±15	•	•	•	•	•
KSD125****	125±5	85±15	•	•	•	•	•
KSD130****	130±5	90±15	•	•	•	•	•
KSD135****	135±5	95±15	•	•	•	•	•
KSD140****	140±5	100±15	•	•	•	•	•
KSD145****	145±5	100±15	•	•	•	•	•
KSD150****	150±5	105±15	•	•	•	•	•

Note: Reset Temperature only reference

8. ORDERING INFORMATION

The following information are necessary in order to place your order with us correctly:

Model No	Reset Temperature	Supplementary Code	Quantity
KSD05			



9. PACKING INFORMATION

Packing details

Unit:mm

Plastic bag

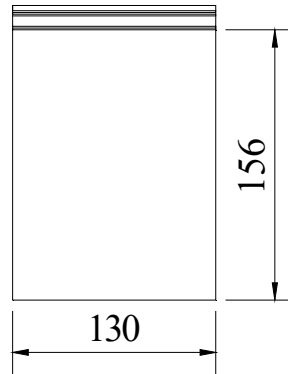

Inner Box

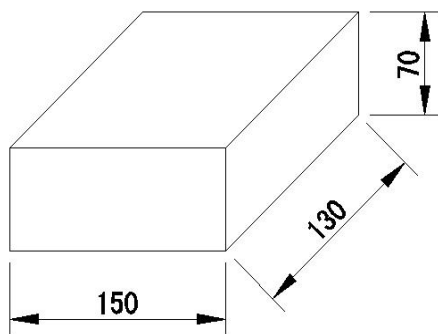

Master Carton

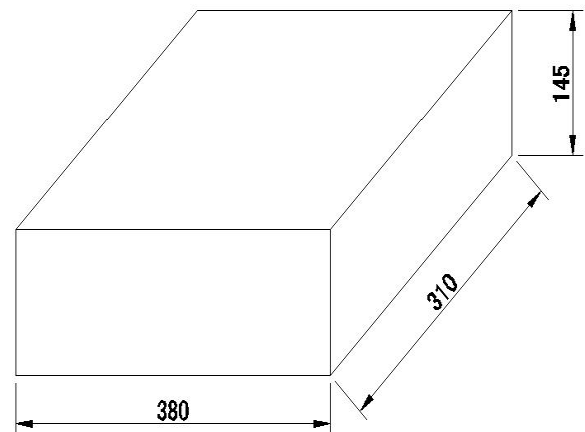

Net Weight (200pcs/bag)	302g	Inner box weight	975g	Master Carton Weight	10.2kg
Qty per bag	200pcs	Qty per box	600pcs	Qty per carton	6000pcs



10. APPENDIX



ONLINE CERTIFICATIONS DIRECTORY

YFZW2.E215779

Thermal Motor Protectors and Protectors for Hermetic and Semi-hermetic Compressors - Component

[Page Bottom](#)

Thermal Motor Protectors and Protectors for Hermetic and Semi-hermetic Compressors - Component

[See General Information for Thermal Motor Protectors and Protectors for Hermetic and Semi-hermetic Compressors - Component](#)

DONGGUAN BETTER ELECTRONICS TECHNOLOGY CO LTD

E215779

RM 601 OF 16 BLK

XINZHUYUAN NO 4 XINZHU RD

SONGSHANLAKE HIGHTECH INDUSTRIAL DEVELOPMENT ZONE

DONGGUAN, GUANGDONG 523808 CHINA

Thermal Motor Protectors, Model(s) ATM-01 Series, ATM-01P Series

Thermal protectors, auto reset, Model(s) Series KSD

Marking: Company name, model designation and the Recognized Component Mark,  .

Last Updated on 2015-11-10

[Questions?](#)

[Print this page](#)

[Terms of Use](#)

[Page Top](#)

◆ 2016 UL LLC

The appearance of a company's name or product in this database does not in itself assure that products so identified have been manufactured under UL's Follow-Up Service. Only those products bearing the UL Mark should be considered to be Certified and covered under UL's Follow-Up Service. Always look for the Mark on the product.

UL permits the reproduction of the material contained in the Online Certification Directory subject to the following conditions: 1. The Guide Information, Assemblies, Constructions, Designs, Systems, and/or Certifications (files) must be presented in their entirety and in a non-misleading manner, without any manipulation of the data (or drawings). 2. The statement "Reprinted from the Online Certifications Directory with permission from UL" must appear adjacent to the extracted material. In addition, the reprinted material must include a copyright notice in the following format: "© 2016 UL LLC".

XAPX2.E468091 - TEMPERATURE-INDICATING AND -REGULATING EQUIPMENT - COMPONENT

Temperature-indicating and -Regulating Equipment - Component

See General Information for Temperature-indicating and -Regulating Equipment - Component

DONGGUAN BETTER ELECTRONICS TECHNOLOGY CO LTD

E468091

Rm 601 Of 16 Blk
Xinzhu Yuan No 4 Xinzhu Rd
Songshanlake Hightech Industrial Development Zone
Dongguan, Guangdong 523808 CHINA

Protective control, Thermal cut-out Model(s) ATM-01

Investigated to UL-60730-1

Protective control, Voltage maintained thermal cut-out Model(s) ATM-01P

Investigated to UL-60730-1, UL 60730-2-9

Thermostat Model(s) Model KSD05 Series

Protective control, Model(s) Thermal cut-ou ATM-01 Series, Voltage maintained thermal cut-outATM-01P Series

Model(s) KST-A, KST-B, KST-C, KST-D, KST-R

Marking: Company name and model designation.

Last Updated on 2018-11-01

The appearance of a company's name or product in this database does not in itself assure that products so identified have been manufactured under UL's Follow-Up Service. Only those products bearing the UL Mark should be considered to be Certified and covered under UL's Follow-Up Service. Always look for the Mark on the product.

UL permits the reproduction of the material contained in the Online Certification Directory subject to the following conditions: 1. The Guide Information, Assemblies, Constructions, Designs, Systems, and/or Certifications (files) must be presented in their entirety and in a non-misleading manner, without any manipulation of the data (or drawings). 2. The statement "Reprinted from the Online Certifications Directory with permission from UL" must appear adjacent to the extracted material. In addition, the reprinted material must include a copyright notice in the following format: "© 2019 UL LLC"

Zertifikat

Certificate



Zertifikat Nr. *Certificate No.*
R 50289642

Blatt *Page*
0001

Ihr Zeichen *Client Reference*

Unser Zeichen *Our Reference*
05-RW- 16056841 001

Ausstellungsdatum
31.07.2014

Date of Issue
(day/mo/yr)

Genehmigungsinhaber *License Holder*

Dongguan Better Electronics
Technology Co., Ltd.
Room 601 of 16 Block, Xinzhu Yuan
No 4, Xinzhu Road, Songshan Lake
Hightech Industrial Development Zone
Dongguan City, Guangdong Province
P.R. China

Fertigungsstätte *Manufacturing Plant*

FOSHAN WHOLESOME ELECTRONICS
CO., LTD.
No. 17 Wufeng Industrial Zone
Dasha Road, Zhangcha
Foshan, Guangdong 528000
P.R. China

Prüfzeichen *Test Mark*



Type Approved
Safety
Regular Production
Surveillance

www.tuv.com
ID 2000000000

Geprüft nach *Tested acc. to*

EN 60730-1:2000+A1+A2+A12+A13+A14+A16
EN 60730-2-2:2002+A1+A11

Zertifiziertes Produkt *(Geräteidentifikation)*

Certified Product (Product Identification)

Lizenzentgelte - Einheit

License Fee - Unit

Motor Protection Switch *(Thermal Motor Protector)*

Type Designation : KSD 7
Trademark : Better (logo)
Rated Voltage : 1) AC 250V; 50Hz or 2) DC 24V
Rated Current : 1) 5A or 2) 10A
Construction : Incorporated control
for class I or II equipment
Switching Temperature : 60°C - 150°C (Metal Shell)
60°C - 120°C (Plastic Shell)
Degree of Protection : IP00
Degree of Pollution : 2
Action Type : 3.C
Type of Disconnection : Micro-interruption
Glow Wire Temperature : 850°C

Remark : The labelling requirements acc. to EU Directive
2001/95 have to be observed for distribution within the EEA.
The installation has to be carried out according to
installation instruction accompanying the products.

ANLAGE (Appendix): 1

Dem Zertifikat liegt unsere Prüf- und Zertifizierungsordnung zugrunde und es bestätigt die Konformität
des Produktes mit den oben genannten Standards und Prüfgrundlagen. Zusätzliche Anforderungen
in Ländern, in denen das Produkt in Verkehr gebracht werden soll, müssen zusätzlich
betrachtet werden. Die Herstellung des zertifizierten Produktes wird überwacht.

This certificate is based on our Testing and Certification Regulation and states the conformity
of the product with the standards and testing requirements as indicated above. Any additional
requirements in countries where the product is going to be marketed have to be considered
additionally. The manufacturing of the certified product is subject to surveillance.

TÜV Rheinland LGA Products GmbH - Tillystraße 2 - 90431 Nürnberg

Tel.: (+49/221) 8 06 - 13 71 e-mail: cert-validity@de.tuv.com
Fax: (+49/221) 8 06 - 39 35 http://www.tuv.com/safety

Zertifizierungsstelle



Dipl.-Ing. (FH) T. Zimmer

Zertifikat

Certificate



Zertifikat Nr. *Certificate No.*
R 50289642

Blatt *Page*
0002

<i>Ihr Zeichen Client Reference</i>	<i>Unser Zeichen Our Reference</i>	<i>Ausstellungsdatum</i>	<i>Date of Issue</i> (day/mo/yr)
	05-YFC- 16056841 002	22.07.2016	

Genehmigungsinhaber *License Holder*
Dongguan Better Electronics
Technology Co., Ltd.
Room 601 of 16 Block, Xinzhu Yuan
No 4, Xinzhu Road, Songshanlake
Hightech Ind. Development Zone
Dongguan City, Guangdong Province
P.R. China

Fertigungsstätte *Manufacturing Plant*
Dongguan Better Electronics
Technology Co., Ltd.
Nanmen Village, Hengkeng
Administrative Zone, Liaobu Town
Dongguan, Guangdong
P.R. China

Prüfzeichen *Test Mark*



Geprüft nach *Tested acc. to*
EN 60730-1:2000+A1+A2+A12+A13+A14+A16
EN 60730-2-2:2002+A1+A11

Zertifiziertes Produkt (Geräteidentifikation)
Certified Product (Product Identification)

Lizenzentgelte - Einheit
License Fee - Unit

Motor Protection Switch (Thermal Motor Protector)

as page 0001

Change

Name of the factory : see above
Address of the factory : see above

Remark : The labelling requirements acc. to EU Directive 2001/95 have to be observed for distribution within the EEA. The installation has to be carried out according to installation instruction accompanying the products.

Dem Zertifikat liegt unsere Prüf- und Zertifizierungsordnung zugrunde und es bestätigt die Konformität des Produktes mit den oben genannten Standards und Prüfgrundlagen. Zusätzliche Anforderungen in Ländern, in denen das Produkt in Verkehr gebracht werden soll, müssen zusätzlich betrachtet werden. Die Herstellung des zertifizierten Produktes wird überwacht.
This certificate is based on our Testing and Certification Regulation and states the conformity of the product with the standards and testing requirements as indicated above. Any additional requirements in countries where the product is going to be marketed have to be considered additionally. The manufacturing of the certified product is subject to surveillance.

TÜV Rheinland LGA Products GmbH - Tillystraße 2 - 90431 Nürnberg
Tel.: (+49/221)8 06 - 13 71 e-mail: cert-validity@de.tuv.com
Fax: (+49/221)8 06 - 39 35 http://www.tuv.com/safety

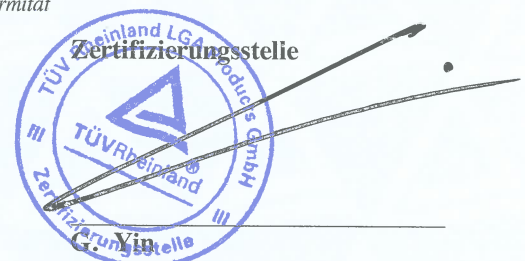

Zertifikat

Certificate



Zertifikat Nr. *Certificate No.*
R 50289642

Blatt *Page*
0003

Ihr Zeichen *Client Reference*

Unser Zeichen *Our Reference*

Ausstellungsdatum

Date of Issue
(day/mo/yr)

05-YFC- 16056841 003

09.08.2017

Genehmigungsinhaber *License Holder*

Dongguan Better Electronics
Technology Co., Ltd.
Room 601 of 16 Block, Xinzhu Yuan
No 4, Xinzhu Road, Songshanlake
Hightech Ind. Development Zone
Dongguan City, Guangdong Province
P. R. China

Fertigungsstätte *Manufacturing Plant*

Dongguan Better Electronics
Technology Co., Ltd.
Nanmen Village, Hengkeng
Administrative Zone, Liaobu Town
Dongguan, Guangdong
P. R. China

Prüfzeichen *Test Mark*



Type Approved
Safety
Regular Production
Surveillance

www.tuv.com
ID 2000000000

Geprüft nach *Tested acc. to*

EN 60730-1:2000+A1+A2+A12+A13+A14+A16

EN 60730-2-2:2002+A1+A11

Zertifiziertes Produkt (Geräteidentifikation)

Certified Product (Product Identification)

Lizenzentgelte - Einheit

License Fee - Unit

Motor Protection Switch (Thermal Motor Protector)

as page 0001-0002

Additional

Rated current : 1) 2A, AC 250V;
2) 3A, DC 24V

Remark : The labelling requirements acc. to EU Directive
2001/95 have to be observed for distribution within the EEA.
The installation has to be carried out according to
installation instruction accompanying the products.

Dem Zertifikat liegt unsere Prüf- und Zertifizierungsordnung zugrunde und es bestätigt die Konformität des Produktes mit den oben genannten Standards und Prüfgrundlagen. Zusätzliche Anforderungen in Ländern, in denen das Produkt in Verkehr gebracht werden soll, müssen zusätzlich betrachtet werden. Die Herstellung des zertifizierten Produktes wird überwacht.
This certificate is based on our Testing and Certification Regulation and states the conformity of the product with the standards and testing requirements as indicated above. Any additional requirements in countries where the product is going to be marketed have to be considered additionally. The manufacturing of the certified product is subject to surveillance.

TÜV Rheinland LGA Products GmbH - Tillystraße 2 - 90431 Nürnberg

Tel.: (+49/221)8 06 - 13 71 e-mail: cert-validity@de.tuv.com
Fax: (+49/221)8 06 - 39 35 http://www.tuv.com/safety

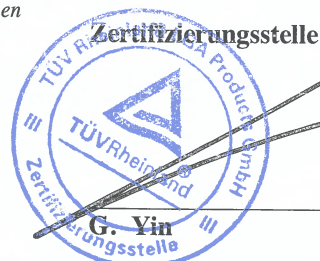

Zertifikat *Certificate*



Zertifikat Nr. *Certificate No.*
R 50289642

Blatt *Page*
0004

Ihr Zeichen *Client Reference*

Unser Zeichen *Our Reference*
05-RW- 16056841 004

Ausstellungsdatum
30.07.2019

Date of Issue
(day/month)

Genehmigungsinhaber *License Holder*

Dongguan Better Electronics
Technology Co., Ltd.
Room 601 of 16 Block, Xinzhuoyuan
No 4, Xinzhu Road, Songshanlake
Hightech Ind. Development Zone
Dongguan City, Guangdong Province
P. R. China

Fertigungsstätte *Manufacturing Plant*

Dongguan Better Electronics
Technology Co., Ltd. ,
Second Branch Factory
No.7, Sanhe Road, Hengkeng
Administrative Zone, Liaobu Town,
Dongguan City, Guangdong Province
P. R. China

Prüfzeichen *Test Mark*



Geprüft nach *Tested acc. to*

EN 60730-1:2000+A1+A2+A12+A13+A14+A16
EN 60730-2-2:2002+A1+A11

Zertifiziertes Produkt (Geräteidentifikation)
Certified Product (Product Identification)

Lizenzentgelte - Einheit
License Fee - Unit

Motor Protection Switch (Thermal Motor Protector)

as pages 0001-0003

Change

Address and name of factory : See above

Remark : The labelling requirements acc. to EU Directive
2001/95 have to be observed for distribution within the EEA.
The installation has to be carried out according to
installation instruction accompanying the products.

*Dem Zertifikat liegt unsere Prüf- und Zertifizierungsordnung zugrunde und es bestätigt die Konformität
des Produktes mit den oben genannten Standards und Prüfgrundlagen. Zusätzliche Anforderungen
in Ländern, in denen das Produkt in Verkehr gebracht werden soll, müssen zusätzlich
betrachtet werden. Die Herstellung des zertifizierten Produktes wird überwacht.
This certificate is based on our Testing and Certification Regulation and states the conformity
of the product with the standards and testing requirements as indicated above. Any additional
requirements in countries where the product is going to be marketed have to be considered
additionally. The manufacturing of the certified product is subject to surveillance.*

TÜV Rheinland LGA Products GmbH - Tillystraße 2 - 90431 Nürnberg
Tel : (+49/221)8 06 - 13 71 e-mail cert-validity@de.tuv.com
Fax: (+49/221)8 06 - 39 35 <http://www.tuv.com/safety>



Zertifikat

Certificate



Zertifikat Nr. *Certificate No.*
R 50427761

Blatt *Sheet*
0001

Ihr Zeichen *Client Reference*

Unser Zeichen *Our Reference*

Ausstellungsdatum

Date of Issue

05-xieb-50201676 001

28.04.2019

(day/mo/yr)

Genehmigungsinhaber *License Holder*

Dongguan Better Electronics
Technology Co., Ltd.
Room 601 of 16 Block, Xinzhuoyuan
No 4, Xinzhu Road, Songshanlake
Hightech Ind. Development Zone
Dongguan City, Guangdong Province
P. R. China

Fertigungsstätte *Manufacturing Plant*

Dongguan Better Electronics
Technology Co., Ltd. ,
Second Branch Factory
No.7, Sanhe Road, Hengkeng
Administrative Zone, Liaobu Town,
Dongguan City, Guangdong Province
P. R. China

Prüfzeichen *Test Mark*



Type Approved
Safety
Regular Production
Surveillance

www.tuv.com
ID 1413059417

Geprüft nach *Tested acc. to*

EN 60730-1:2016

EN 60730-2-9:2010

Zertifiziertes Produkt (Geräteidentifikation)

Certified Product (Product Identification)

Lizenzentgelte - Einheit

License Fee - Unit

Temperature Control (Thermostat)

Type Designation : KSD 05xyz
(x = P or M, y = C or O, z = 60°C-150°C)
Trademark: : Better (logo)
Rated Voltage : 1) AC 250V, 50Hz/60Hz
2) DC 24V
Rated Current : 1) 5A 2) 8A
Operating Temperature : 60°C-150°C
Automatic Operation Cycles : 10,000 (Automatic reset)
Type of Disconnection : Micro-interruption
Action Type : Type 2.C
Manufacturing deviation and drift: ±5°C
Degree of Protection : 2
Glow wire temperature : 850°C (for plastic case)
PTI : 175V (for plastic case)
Rated Impules Voltage : 2500V
Construction : Incorporated Control for
Class I or II Equipment

6

Remark : The labelling requirements acc. to EU Directive
2001/95 have to be observed for distribution within the EEA.
The installation has to be carried out according to
installation instruction accompanying the products.

ANLAGE (Appendix) : 1

6

Dem Zertifikat liegt unsere Prüf- und Zertifizierungsordnung zugrunde und es bestätigt die Konformität
des Produktes mit den oben genannten Standards und Prüfgrundlagen. Zusätzliche Anforderungen
in Ländern, in denen das Produkt in Verkehr gebracht werden soll, müssen zusätzlich
betrachtet werden. Die Herstellung des zertifizierten Produktes wird überwacht.

This certificate is based on our Testing and Certification Regulation and states the conformity
of the product with the standards and testing requirements as indicated above. Any additional
requirements in countries where the product is going to be marketed have to be considered
additionally. The manufacturing of the certified product is subject to surveillance.

TÜV Rheinland LGA Products GmbH, Tillystraße 2, 90431 Nürnberg

Tel.: +49 221 806-1371 e-mail: cert-validity@de.tuv.com
Fax: +49 221 806-3935 http://www.tuv.com/safety





PRODUCT CERTIFICATE

CERTIFICATE NO.: CQC14002119169

NAME AND ADDRESS OF THE APPLICANT

Dongguan Better Electronics Technology Co., Ltd.
Room 601 of 16 Block, Xinzhu Yuan, No 4, Xinzhu Road, Songshanlake Hightech Industrial Development
Zone, Dongguan City

NAME AND ADDRESS OF THE MANUFACTURER

Dongguan Better Electronics Technology Co., Ltd.
Room 601 of 16 Block, Xinzhu Yuan, No 4, Xinzhu Road, Songshanlake Hightech Industrial Development
Zone, Dongguan City

NAME AND ADDRESS OF THE FACTORY

Dongguan Better Electronics Technology Co.,Ltd. (V036003)
No.7, Sanhe Road, Hengkeng Administrative Zone, Liaobu Town, Dongguan City, Guangdong Province,
P.R.C.

PRODUCT NAME, MODEL AND SPECIFICATION

THERMAL PROTECTOR

KSD series 250VAC 2A; 250VAC 5A ; 24VDC 3A; 24VDC 10A action Temperature Range:60℃~120℃
Type 3.C

THE STANDARDS AND TECHNICAL REQUIREMENTS FOR THE PRODUCTS

GB/T14536.1-2008;GB/T14536.3-2008

TYPE OF CERTIFICATION SCHEMES

Type Testing of Product + Initial Factory Inspection + Follow up Factory Inspection

This is to certify that the above mentioned product(s) complies with the requirements of certification
rules of CQC11-448321-2016 .

Valid from: Jul.31,2019

The validity of the certificate is subject to positive result of the regular follow up inspection by issuing
certification body.

Date of original issued: Dec.08 2014

President: _____

Lu Mei



CHINA QUALITY CERTIFICATION CENTRE

Section 9, No.188, Nansihuan Xilu, Beijing 100070 P.R.China
<http://www.cqc.com.cn>



PRODUCT CERTIFICATE

CERTIFICATE NO.: CQC14002119582

NAME AND ADDRESS OF THE APPLICANT

Dongguan Better Electronics Technology Co., Ltd.
Room 601 of 16 Block, Xinzhu Yuan, No 4, Xinzhu Road, Songshanlake Hightech Industrial Development
Zone, Dongguan City

NAME AND ADDRESS OF THE MANUFACTURER

Dongguan Better Electronics Technology Co., Ltd.
Room 601 of 16 Block, Xinzhu Yuan, No 4, Xinzhu Road, Songshanlake Hightech Industrial Development
Zone, Dongguan City

NAME AND ADDRESS OF THE FACTORY

Dongguan Better Electronics Technology Co., Ltd. (V036003)
No.7, Sanhe Road, Hengkeng Administrative Zone, Liaobu Town, Dongguan City, Guangdong Province,
P.R.C.

PRODUCT NAME, MODEL AND SPECIFICATION

THERMAL PROTECTOR

KSD series 250VAC 2A; 250VAC 5A ; 24VDC 3A; 24VDC 10A operation temperature range:
60°C-150°C, Type 3.C, metal shell

THE STANDARDS AND TECHNICAL REQUIREMENTS FOR THE PRODUCTS

GB/T14536.1-2008;GB/T14536.3-2008

TYPE OF CERTIFICATION SCHEMES

Type Testing of Product + Initial Factory Inspection + Follow up Factory Inspection

This is to certify that the above mentioned product(s) complies with the requirements of certification
rules of CQC11-448321-2016 .

Valid from: Jul.31,2019

The validity of the certificate is subject to positive result of the regular follow up inspection by issuing
certification body.

Date of original issued: Dec.08 2014

President:

Lu Mei



CHINA QUALITY CERTIFICATION CENTRE

Section 9, No.188, Nansihuan Xilu, Beijing 100070 P.R.China
<http://www.cqc.com.cn>



PRODUCT CERTIFICATE

CERTIFICATE NO.: CQC19002215328

NAME AND ADDRESS OF THE APPLICANT

Dongguan Better Electronics Technology Co., Ltd.
Room 601 of 16 Block, Xinzhu Yuan, No 4, Xinzhu Road, Songshanlake Hightech Industrial Development Zone, Dongguan City

NAME AND ADDRESS OF THE MANUFACTURER

Dongguan Better Electronics Technology Co., Ltd.
Room 601 of 16 Block, Xinzhu Yuan, No 4, Xinzhu Road, Songshanlake Hightech Industrial Development Zone, Dongguan City

NAME AND ADDRESS OF THE FACTORY

Dongguan Better Electronics Technology Co., Ltd. , Second Branch Factory (V036003)
No.7, Sanhe Road, Hengkeng Administrative Zone, Liaobu Town, Dongguan City, Guangdong Province, P.R.C.

PRODUCT NAME, MODEL AND SPECIFICATION

Thermostat

KSD 05 series: 250Vac 5A 50Hz or 60Hz, 24Vdc 8A, Action Temperature Range: 60°C-140°C , Type 2C, 10000 Cycles, Automatic reset, Plastic shell

THE STANDARDS AND TECHNICAL REQUIREMENTS FOR THE PRODUCTS

GB/T14536.1-2008;GB/T14536.10-2008

TYPE OF CERTIFICATION SCHEMES

Type Testing of Product + Follow up Factory Inspection

This is to certify that the above mentioned product(s) complies with the requirements of certification rules of CQC11-448321-2016 .

Valid from: Mar.27,2019

The validity of the certificate is subject to positive result of the regular follow up inspection by issuing certification body.

Accredited by China National Accreditation Service for Conformity Assessment CNAS C001-P

President:

Lu Mei



CHINA QUALITY CERTIFICATION CENTRE

Section 9, No.188, Nansihuan Xilu, Beijing 100070 P.R.China
<http://www.cqc.com.cn>

C 0143379



PRODUCT CERTIFICATE

CERTIFICATE NO.: CQC19002215329

NAME AND ADDRESS OF THE APPLICANT

Dongguan Better Electronics Technology Co., Ltd.
Room 601 of 16 Block, Xinzhu Yuan, No 4, Xinzhu Road, Songshanlake Hightech Industrial Development
Zone, Dongguan City

NAME AND ADDRESS OF THE MANUFACTURER

Dongguan Better Electronics Technology Co., Ltd.
Room 601 of 16 Block, Xinzhu Yuan, No 4, Xinzhu Road, Songshanlake Hightech Industrial Development
Zone, Dongguan City

NAME AND ADDRESS OF THE FACTORY

Dongguan Better Electronics Technology Co., Ltd. , Second Branch Factory (V036003)
No.7, Sanhe Road, Hengkeng Administrative Zone, Liaobu Town, Dongguan City, Guangdong Province,
P.R.C.

PRODUCT NAME, MODEL AND SPECIFICATION

Thermostat

KSD 05 series: 250Vac 5A 50Hz or 60Hz, 24Vdc 8A. Action Temperature Range: 60°C-150°C , Type 2C,
10000 Cycles, Automatic reset, Metal shell

THE STANDARDS AND TECHNICAL REQUIREMENTS FOR THE PRODUCTS

GB/T14536.1-2008;GB/T14536.10-2008

TYPE OF CERTIFICATION SCHEMES

Type Testing of Product + Follow up Factory Inspection

This is to certify that the above mentioned product(s) complies with the requirements of certification
rules of CQC11-448321-2016 .

Valid from: Mar.27,2019

The validity of the certificate is subject to positive result of the regular follow up inspection by issuing
certification body.

Accredited by China National Accreditation Service for Conformity Assessment CNAS 0001-P

President: _____

Lu Mei



CHINA QUALITY CERTIFICATION CENTRE

Section 9, No.188, Nansihuan Xilu, Beijing 100070 P.R.China
<http://www.cqc.com.cn>

접수번호 : 19-018646-01-1
(Receipt No.)



안전확인신고 증명서

Confirmation Letter of Declaration

신고번호 (Application No.) : ZU02109-19001

신고회사명 (Applicant) : Dongguan Better Electronics Technology Co.,Ltd.,Second Branch Factory

주소 (Address) : No.7,Sanhe Road,Hengkeng Administrative Zone, Liaobu Town, Dongguan City 523413,Guangdong Province,China

제품명 (Product) : 온도과승방지장치 (Thermal cut out)

기본모델명 (Basic Model) : KSD 05MC 150℃

파생모델명 (Series Model) : See the attachment 2

정격/안전기준상의 모델구분 (Rating) : AC 250 V, 5 A, 150 ℃

안전기준 (Standard) : K60730-2-9(2011-12), KC60730-1(2015-09)

본 확인신고는 제조국명 : 중국
 제조업자명 : Dongguan Better Electronics Technology Co.,Ltd.,Second Branch Factory
 제조공장의 주소 : No.7, Sanhe Road, Hengkeng Administrative Zone, Liaobu Town, Dongguan City 523413, Guangdong Province, China
 의 제품에만 해당함

「전기용품 및 생활용품 안전관리법 시행규칙」 제28조제1항, 같은 조 제3항, 제29조제2항 또는 제34조제2항에 따라 안전확인신고 증명서를 발급합니다.

We issue this Confirmation Letter of Declaration of the Safety Confirmation for the above appliance in accordance with the Article 28(1), 28(3), 29(2) or 34(2) of the Enforcement Rule of the Electrical Appliances and Consumer Products Safety Control Act.

2019 년 04 월 10 일
Year month day

한국산업기술시험원장

KOREA TESTING LABORATORY



* 이 신고증명서는 「전기용품 및 생활용품 안전관리법」에 따른 제품의 안전성 확인에 한정된 것이며, 그 밖의 다른 법률이 적용되는 제품의 경우에는 해당 법률에 따라 추가로 인증·허가 등을 받아야 합니다.

첨부서류	1. 전기용품의 안전관리부품 및 재질목록(List of Critical Components)(전기용품에 한정한다) 2. 기본모델·파생모델의 내용(Description of the basic and series model) 3. 안전확인신고 내용의 변경 현황(Revisions Status)
------	---

접 수 번 호 : 19-018646-02-1
(Receipt No.)



안전확인신고 증명서

Confirmation Letter of Declaration

신 고 번 호 (Application No.) : ZU02109-19002

신 고 회 사 명 (Applicant) : Dongguan Better Electronics Technology Co.,Ltd.,Second Branch Factory

주 소 (Address) : No.7,Sanhe Road,Hengkeng Administrative Zone, Liaobu Town, Dongguan City 523413,Guangdong Province,China

제 품 명 (Product) : 온도과승방지장치 (Thermal cut out)

기 본 모 델 명 (Basic Model) : KSD 05PC 140℃

파 생 모 델 명 (Series Model) : See the attachment 2

정격/안전기준상의 모델구분 (Rating) : AC 250 V, 5 A, 140 ℃

안 전 기 준 (Standard) : K60730-2-9(2011-12), KC60730-1(2015-09)

본 확인신고는 제 조 국 명 : 중국
 제조업자 명 : Dongguan Better Electronics Technology Co.,Ltd.,Second Branch Factory
 제조공장의 주소 : No.7, Sanhe Road, Hengkeng Administrative Zone, Liaobu Town, Dongguan City 523413, Guangdong Province, China
 의 제품에만 해당함

「전기용품 및 생활용품 안전관리법 시행규칙」 제28조제1항, 같은 조 제3항, 제29조제2항 또는 제34조제2항에 따라 안전확인신고 증명서를 발급합니다.

We issue this Confirmation Letter of Declaration of the Safety Confirmation for the above appliance in accordance with the Article 28(1), 28(3), 29(2) or 34(2) of the Enforcement Rule of the Electrical Appliances and Consumer Products Safety Control Act.

2019 년 04 월 11 일
Year month day

한국산업기술시험원장
KOREA TESTING LABORATORY



* 이 신고증명서는 「전기용품 및 생활용품 안전관리법」에 따른 제품의 안전성 확인에 한정된 것이며, 그 밖의 다른 법률이 적용되는 제품의 경우에는 해당 법률에 따라 추가로 인증·허가 등을 받아야 합니다.

첨부서류	1. 전기용품의 안전관리부품 및 재질목록(List of Critical Components)(전기용품에 한정한다) 2. 기본모델·파생모델의 내용(Description of the basic and series model) 3. 안전확인신고 내용의 변경 현황(Revisions Status)
-------------	---

IEC SYSTEM FOR MUTUAL RECOGNITION OF TEST CERTIFICATES FOR ELECTRICAL EQUIPMENT
(IECEE) CB SCHEME

CB TEST CERTIFICATE

Product	Thermal cut-out
Name and address of the applicant	DONGGUAN BETTER ELECTRONICS TECHNOLOGY CO LTD Rm 601 Of 16 Bldg Xinzhuoyuan No 4 Xinzhu Rd Songshanlake Hightech Industrial Development Zone Dongguan, Guangdong 523808 China
Name and address of the manufacturer	Dongguan Better Electronics Technology Co., Ltd., Second Branch Factory No.7, Sanhe Road, Hengkong Administrative Zone, Liaobu Town, Dongguan City 523413, Guangdong Province China
Name and address of the factory	<input type="checkbox"/> Additional information on page 2
Note: When more than one factory, please report on page 2	Dongguan Better Electronics Technology Co., Ltd., Second Branch Factory No.7, Sanhe Road, Hengkong Administrative Zone, Liaobu Town, Dongguan City 523413, Guangdong Province China
Ratings and principal characteristics	Plastic shell: 250Vac 5A, 24Vdc 8A, Action temperature range: 60-140°C, Metal shell: 250Vac 5A, 24Vdc 8A, Action temperature range: 60-150°C
Trademark (if any)	
Customer's Testing Facility (CTF) Stage used	
Model / Type Ref.	KSD 05 series
Additional information (if necessary may also be reported on page 2)	<input type="checkbox"/> Additional information on page 2
A sample of the product was tested and found to be in conformity with	IEC 60730-1:2013, IEC 60730-1:2013/AMD1:2015, IEC 60730-2-9:2015, IEC 60730-2-9:2015/AMD1:2018 National differences: EU Group Differences
As shown in the Test Report Ref. No. which forms part of this Certificate	4350154.50

This CB Test Certificate is issued by the National Certification Body

DEKRA Certification B.V.
Meander 1051, NL-6825 MJ Arnhem, Netherlands