

REV.	DESCRIPTION	DATE	DRAFTER	APPROVER
A1	DWG.REL	2020.5.23	ZHANG	JIN

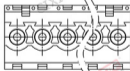
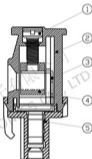
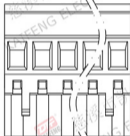
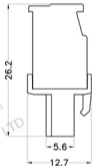
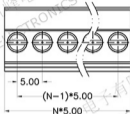

- Material
 - ①Screw : M3.0 steel, Zinc plated, *-- slot type
 - ②Housing : PA66, UL94V-0
 - ③Contact : Copper alloy, Tin plated
 - ④Clamp : Copper alloy, Ni plated
 - ⑤Cover : PA66, UL94V-0

- Electrical
 - UL IEC
 - Rated voltage : 300V 320V
 - Rated current : 15A 18A
 - Contact resistance : 20mΩ(Max)
 - Insulation resistance: 500MΩ/DC500V
 - Withstanding Voltage : AC2000V/1min
 - Wire range: 2B-12AWG 2.5mm²

- Mechanical
 - Operating temperature: -40℃ ~ +105℃
 - Soldering temperature: 250℃ ±5/5sec
 - Torque: 0.5N.m (4.43lb.in)
 - Strip length: 7-8mm

- RohS compliance

HOW TO ORDER
 KF2EDGKA-5.0-XXP-1 X-XXXXX

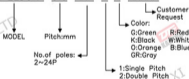

Pitch range		Nominal dimension range				PROJECTION	TITLE	
>0	>6	>10	>0	>30	>60	>100	6.1/10	
6	10	24	30	60	100	150	<	
±0.15(±0.20)		±0.30	±0.30	±0.50	±0.70	±1.00	±1.30	±2
DRAWING TYPE		CUSTOMER DRAWING						
SCALE		1:1		SHEET		1 OF 1		
DRAWING NO.		W10000282						
PROJECTION							TITLE	
UNIT							mm	
SHEET SIZE							A4	
SERIES							KF2EDGKA	
慈溪市凯峰电子有限公司 CIXI KAIFENG ELECTRONICS CO.,LTD							KF2EDGKA-5.0-XXP-1X	

REV.	DESCRIPTION	DATE	DRAFTER	APPROVER
A1	DWG.REL	2020.5.23	ZHANG	JIN

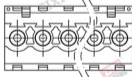
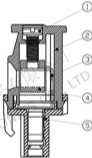
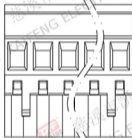
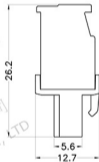
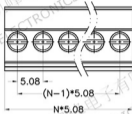

- Material
 - ①Screw : M3.0 steel, Zinc plated, "—" slot type
 - ②Housing : PA66, UL94V-0
 - ③Contact : Copper alloy, Tin plated
 - ④Clamp : Copper alloy, Ni plated
 - ⑤Cover : PA66, UL94V-0

- Electrical
 - UL IEC
 - Rated voltage : 300V 320V
 - Rated current : 15A 18A
 - Contact resistance : 20mΩ(Max)
 - Insulation resistance : 500MΩ/DC500V
 - Withstanding Voltage : AC2000V/1min
 - Wire range : 28-12AWG 2.5mm²

- Mechanical
 - Operating temperature: -40°C ~ +105°C
 - Soldering temperature: 250°C ±5/5sec
 - Torque : 0.5N.m (4.43Lb.in)
 - Strip length: 7-8mm

- RoHS compliance

HOW TO ORDER
 KF2EDGKA-5.08-XXP-1 X-XXXX



Pitch range	Nominal dimension range	PROJECTION	UNIT	TITLE
>0	>0	0.1/10	mm	KF2EDGKA-5.08-XXP-1X
>6	>60	<	A4	SERIES KF2EDGKA
±0.15(±0.20)	±0.30(±0.50)			
±0.10(±0.15)	±0.20(±0.30)			
CUSTOMER DRAWING		慈溪市凯峰电子有限公司 CIXI KAIFENG ELECTRONICS CO.,LTD		
SCALE	1:1 SHEET 1 OF 1			
DRAWING NO.	W10000302			

REV.	DESCRIPTION	DATE	DRAFTER	APPROVER
A1	DWG.REL	2020.5.23	ZHANG	JIN

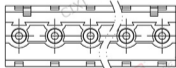
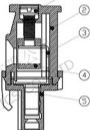
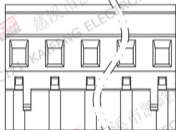
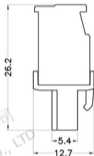
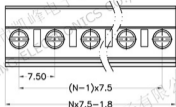

• Material

①Screw : M2.5 steel, Zinc plated, "—" slot type
 ②Housing : PA66, UL94V-0
 ③Contact : Copper alloy, Tin plated
 ④Clamp : Copper alloy, Ni plated
 ⑤Cover : PA66, UL94V-0

• Electrical

UL IEC
 Rated voltage : 300V 400V
 Rated current : 15A 18A
 Contact resistance : 20mΩ(Max)
 Insulation resistance : 500MΩ/DC500V
 Withstanding Voltage : AC2500V/1min
 Wire range : 28-12AWG 2.5mm²

• Mechanical

Operating temperature: -40°C ~ +105°C
 Soldering temperature: 250°C ±5/5sec
 Torque : 0.4N.m (3.54Lb.in)
 Strip length : 7-8mm

• RoHS compliance

HOW TO ORDER

KF2EDGKA-7.5-XXP-1 X-XXXXX



Pitch range		Nominal dimension range					PROJECTION	TITLE
>0	>6	>10	>0	>30	>60	>100	6.1/10	KF2EDGKA-7.5-XXP-1X
6	10	24	30	60	100	150	<	SHEET SIZE A4
±0.15 (±0.20)		±0.30	±0.30	±0.50	±0.70	±1.00	±1.30	SERIES KF2EDGKA
DRAWING TYPE		CUSTOMER DRAWING						
SCALE		1:1 SHEET 1 OF 1						
DRAWING NO.		W10000362						



慈溪市凯峰电子有限公司
 CIXI KAIFENG ELECTRONICS CO., LTD

REV.	DESCRIPTION	DATE	DRAFTER	APPROVER
A1	DWG.REL	2020.5.23	ZHANG	JIN

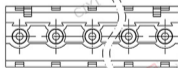
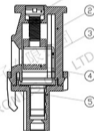
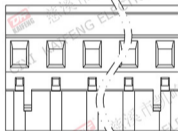
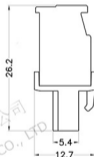
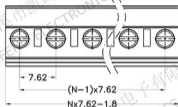

- Material
 - ①Screw : M2.5 steel, Zinc plated, "—" slot type
 - ②Housing : PA66, UL94V-0
 - ③Contact : Copper alloy, Tin plated
 - ④Clamp : Copper alloy, Ni plated
 - ⑤Cover : PA66, UL94V-0

- Electrical
 - UL IEC
 - Rated voltage : 300V 400V
 - Rated current : 15A 18A
 - Contact resistance : 20mΩ(Max)
 - Insulation resistance : 500MΩ/DC500V
 - Withstanding Voltage : AC2500V/1min
 - Wire range : 28-12AWG 2.5mm²

- Mechanical
 - Operating temperature: -40°C ~ +105°C
 - Soldering temperature: 250°C ±5/5sec
 - Torque : 0.4N.m (3.54Lb.in)
 - Strip length : 7-8mm

- RoHS compliance

HOW TO ORDER
KF2EDGKA-7.62-XXP-1 X-XXXX

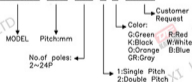

Pitch range	Nominal dimension range	PROJECTION	TITLE
>0	>0	6.1/10	KF2EDGKA-7.62-XXP-1X
6	60	<	SHEET SIZE A4
±0.15	±0.30	±0.50	SERIES KF2EDGKA
DRAWING TYPE CUSTOMER DRAWING		慈溪市凯峰电子有限公司 CIXI KAIFENG ELECTRONICS CO.,LTD	
SCALE 1:1			
DRAWING NO. W10000382			

REV.	DESCRIPTION	DATE	DRAFTER	APPROVER
A1	DWG.REL	2020.5.23	ZHANG	JIN

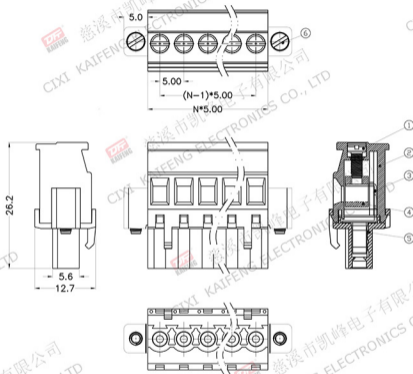

• Material
 @Screw :M3.0 steel,Zinc plated,“-”slot type
 @Housing : PA66, UL94V-0
 @Contact : Copper alloy,Tin plated
 @Clamp : Copper alloy, Ni plated
 @Cover : PA66, UL94V-0
 @Screw :M2.5 steel,Zinc plated,“-”slot type

• Electrical
 UL IEC
 Rated voltage : 300V 320V
 Rated current : 15A 18A
 Contact resistance : 20mΩ(Max)
 Insulation resistance : 500MΩ/DC500V
 Withstanding Voltage : AC2000V/1min
 Wire range : 28-12AWG 2.5mm²

• Mechanical
 Operating temperature: -40℃ ~ +105℃
 Soldering temperature: 250℃ ±5/5sec
 Torque : 0.5N.m (4.43Lb.in)
 Strip length : 7-8mm

• RoHS compliance

HOW TO ORDER

KF2EDGKAM-5.0-XXP-1 X-XXXXX



Pitch range		Nominal dimension range		PROJECTION	TITLE						
>0	>6	>10	>0	>30	>60	>100	0.1/10	UNIT	mm	TITLE	KF2EDGKAM-5.0-XXP-1X
6	10	24	30	60	100	150	<	SHEET SIZE	A4	SERIES	KF2EDGKAM
±0.15		±0.20	±0.30	±0.30	±0.50	±0.70	±1.00	±1.30	±2		
DRAWING TYPE		CUSTOMER DRAWING									
SCALE		1:1 SHEET 1 OF 1									
DRAWING NO.		W10000292									

DF 慈溪市凯峰电子有限公司
 CIXI KAIFENG ELECTRONICS CO.,LTD

REV.	DESCRIPTION	DATE	DRAFTER	APPROVER
A1	DWG.REL	2020.5.23	ZHANG	JIN

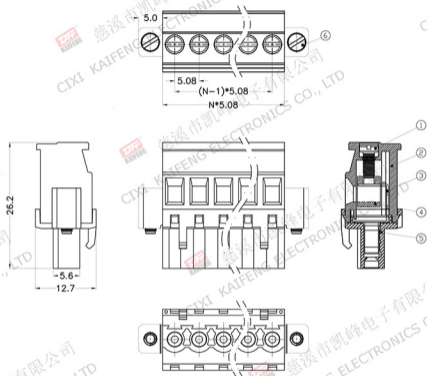

• Material
 @Screw : M3.0 steel, Zinc plated, "—" slot type
 @Housing : PA66, UL94V-0
 @Contact : Copper alloy, Tin plated
 @Clamp : Copper alloy, Ni plated
 @Cover : PA66, UL94V-0
 @Screw : M2.5 steel, Zinc plated, "—" slot type

• Electrical
 UL IEC
 Rated voltage : 300V 320V
 Rated current : 15A 18A
 Contact resistance : 20mΩ(Max)
 Insulation resistance : 500MΩ/DC500V
 Withstanding Voltage : AC2000V/1min
 Wire range : 28-12AWG 2.5mm²

• Mechanical
 Operating temperature : -40℃ ~ +105℃
 Soldering temperature : 250℃ ±5/5sec
 Torque : 0.5N.m (4.43Lb.in)
 Strip length : 7-8mm

• RoHS compliance

HOW TO ORDER

KF2EDGKAM-5.08-XXP-1 X-XXXXX



Pitch range	Nominal dimension range	PROJECTION	TITLE
>0	>0	UNIT	mm
>6	>30	SHEET SIZE	A4
>10	>60	SERIES	KF2EDGKAM
>24	>100	KF2EDGKAM-5.08-XXP-1X	
>30	>150		
±0.15/±0.20	±0.30/±0.50		
±0.30/±0.50	±0.70/±1.00		
±1.00	±1.30		
±2			
DRAWING TYPE		CUSTOMER DRAWING	
SCALE		1:1 SHEET 1 OF 1	
DRAWING NO.		W10000312	

DF

慈溪市凯峰电子有限公司
 CIXI KAIFENG ELECTRONICS CO.,LTD

REV	DESCRIPTION	DATE	DRAWER	APPROVER
A1	DWG.REL	2020.5.23	ZHANG	JIN

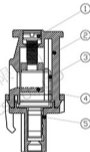
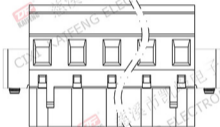
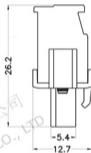
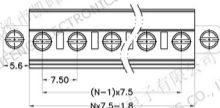

- Material
 - ①Screw : M2.5 steel, Zinc plated, -- slot type
 - ②Housing : PA66, UL94V-0
 - ③Contact : Copper alloy Tin plated
 - ④Clamp : Copper alloy, Ni plated
 - ⑤Cover : PA66, UL94V-0

- Electrical
 - UL IEC
 - Rated voltage : 300V 400V
 - Rated current : 15A 18A
 - Contact resistance : 20mΩ(Max)
 - Insulation resistance: 500MΩ/DC500V
 - Withstanding Voltage : AC2500V/1min
 - Wire range : 28-12AWG 2.5mm²

- Mechanical
 - Operating temperature: -40℃~+105℃
 - Soldering temperature: 250℃±5/5sec
 - Torque : 0.4N.m (3.54Lb.in)
 - Strip length : 7-8mm

- RoHS compliance

HOW TO ORDER
KF2EDGKAM-7.5-XXP-1 X-XXXXX

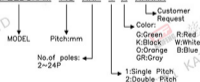

Pitch range	Nominal dimension range	PROJECTION	TITLE
>0	>0	6.1/10	KF2EDGKAM-7.5-XXP-1X
>6	>30	<	SHEET SIZE
8	10	A4	SERIES
>10	>24		KF2EDGKAM
>30	>30		
>60	>60		
>100	>100		
>150	>150		
±0.15	±0.20		
±0.30	±0.30		
±0.50	±0.50		
±0.70	±1.00		
±1.30	±2		
DRAWING TYPE		CUSTOMER DRAWING	
SCALE		1:1 SHEET 1 OF 1	
DRAWING NO.		W10000372	



慈溪市凯峰电子有限公司
CIXI KAIFENG ELECTRONICS CO.,LTD

REV.	DESCRIPTION	DATE	DRAFTER	APPROVER
A1	DWG.REL	2020.5.23	ZHANG	JIN

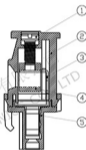
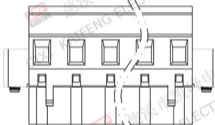
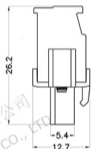
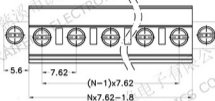

- Material
 - ①Screw : M2.5 steel, Zinc plated, "—" slot type
 - ②Housing : PA66, UL94V-0
 - ③Contact : Copper alloy, Tin plated
 - ④Clamp : Copper alloy, Ni plated
 - ⑤Cover : PA66, UL94V-0

- Electrical
 - UL IEC
 - Rated voltage : 300V 400V
 - Rated current : 15A 18A
 - Contact resistance : 20mΩ(Max)
 - Insulation resistance : 500MΩ/DC500V
 - Withstanding Voltage : AC2500V/1min
 - Wire range : 28-12AWG 2.5mm²

- Mechanical
 - Operating temperature: -40°C~+105°C
 - Soldering temperature: 250°C±5/5sec
 - Torque: 0.4N.m (3.54Lb.in)
 - Strip length: 7-8mm

- RoHS compliance

HOW TO ORDER
KF2EDGKAM-7.62-XXP-1 X-XXXX



Pitch range	Nominal dimension range	PROJECTION	TITLE
>0	>0	UNIT	mm
6	10	SHEET SIZE	A4
10	24	SERIES	KF2EDGKAM
15	30	慈溪市凯峰电子有限公司 CIXI KAIFENG ELECTRONICS CO.,LTD	
20	30		
30	30		
40	30	SCALE	1:1
50	30	CUSTOMER DRAWING	SHEET 1 OF 1
60	30	DRAWING NO.	W10000392

REV.	DESCRIPTION	DATE	DRAFTER	APPROVER
A1	DWG.REL	2020.5.23	ZHANG	JIN

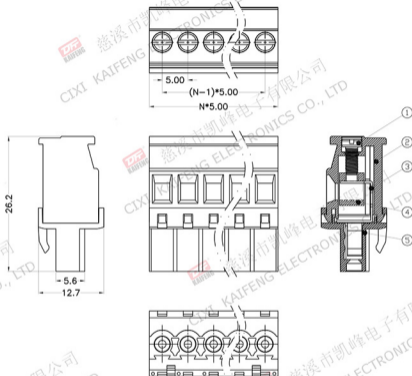

• Material

@Screw : M3.0 steel, Zinc plated, "—" slot type
 @Housing : PA66, UL94V-0
 @Contact : Copper alloy, Tin plated
 @Clamp : Copper alloy, Ni plated
 @Cover : PA66, UL94V-0

• Electrical

UL IEC
 Rated voltage : 300V 320V
 Rated current : 15A 18A
 Contact resistance : 20mΩ(Max)
 Insulation resistance : 500MΩ/DC500V
 Withstanding Voltage : AC2000V/1min
 Wire range : 28-12AWG 2.5mm²

• Mechanical

Operating temperature: -40°C ~ +105°C
 Soldering temperature: 250°C ± 5sec
 Torque : 0.5N.m (4.43Lb.in)
 Strip length: 7-8mm

• RoHS compliance

HOW TO ORDER

KF2EDGKB-5.0-XXP-1 X-XXXX



Pitch range		Nominal dimension range				PROJECTION	TITLE
>0	>6	>10	>0	>30	>60	>100	6.1/10
6	10	24	30	60	100	150	<
±0.15 (±0.20)		±0.30	±0.30	±0.50	±0.70	±1.00	±2
DRAWING TYPE		CUSTOMER DRAWING					
SCALE		1:1 SHEET 1 OF 1					
DRAWING NO.		W10000322					
慈溪市凯峰电子有限公司 CIXI KAIFENG ELECTRONICS CO., LTD							TITLE
UNIT mm SHEET SIZE A4 SERIES KF2EDGKB							KF2EDGKB-5.0-XXP-1X

REV.	DESCRIPTION	DATE	DRAFTER	APPROVER
A1	DWG.REL	2020.5.23	ZHANG	JIN

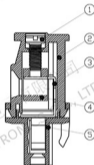
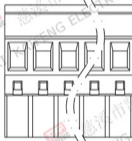
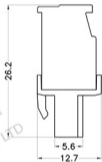
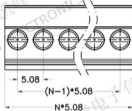

- Material
 - ØScrew : M3.0 steel, Zinc plated, "—" slot type
 - ØHousing : PA66, UL94V-0
 - ØContact : Copper alloy, Tin plated
 - ØClamp : Copper alloy, Ni plated
 - ØCover : PA66, UL94V-0

- Electrical
 - UL IEC
 - Rated voltage : 300V 320V
 - Rated current : 15A 18A
 - Contact resistance : 20mΩ(Max)
 - Insulation resistance : 500MΩ/DC500V
 - Withstanding Voltage : AC2000V/1min
 - Wire range : 28-12AWG 2.5mm²

- Mechanical
 - Operating temperature: -40°C ~ +105°C
 - Soldering temperature: 250°C ±5/5sec
 - Torque : 0.5N.m (4.3Lb.in)
 - Strip length: 7-8mm

- RoHS compliance

HOW TO ORDER

KF2EDGKB-5.08-XXP-1 X-XXXX



Pitch range	Nominal dimension range	PROJECTION
>0	>0	0.1/10
>6	>60	<
>10	>100	>150
±0.15/±0.20/±0.30/±0.30/±0.50/±0.70/±1.00/±1.30	±2	

UNIT	TITLE
mm	KF2EDGKB-5.08-XXP-1X
SHEET SIZE	SERIES
A4	KF2EDGKB

DRAWING NO.	CUSTOMER DRAWING
W10000342	1:1 SHEET 1 OF 1

DF 慈溪市凯峰电子有限公司
CIXI KAIFENG ELECTRONICS CO.,LTD

REV.	DESCRIPTION	DATE	DRAFTER	APPROVER
A1	DWG.REL	2020.5.23	ZHANG	JIN

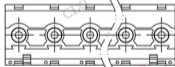
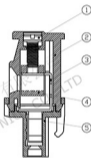
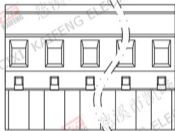
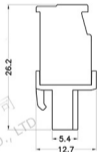
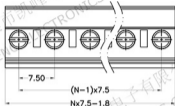

- Material
 - ①Screw : M2.5 steel, Zinc plated, "—" slot type
 - ②Housing : PA66, UL94V-0
 - ③Contact : Copper alloy, Tin plated
 - ④Clamp : Copper alloy, Ni plated
 - ⑤Cover : PA66, UL94V-0

- Electrical
 - UL IEC
 - Rated voltage : 300V 400V
 - Rated current : 15A 18A
 - Contact resistance : 20mΩ(Max)
 - Insulation resistance: 500MΩ/DC500V
 - Withstanding Voltage : AC2500V/1min
 - Wire range: 28-12AWG 2.5mm²

- Mechanical
 - Operating temperature: -40°C ~ +105°C
 - Soldering temperature: 250°C ±5/5sec
 - Torque: 0.4N.m (3.54Lb.in)
 - Strip length: 7-8mm

- RoHS compliance

HOW TO ORDER

KF2EDGKB-7.5-XXP-1 X-XXXX

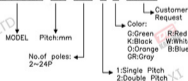

Pitch range		Nominal dimension range					PROJECTION	TITLE
≥0	≤6	≥10	≥0	≥30	≥60	≥100	6.1/10	KF2EDGKB-7.5-XXP-1X
≤6	10	24	30	60	100	150	≤	SHEET SIZE A4
≥0.10	≥0.20	≥0.30	≥0.30	≥0.30	≥0.70	≥1.00	±2'	SERIES KF2EDGKB
DRAWING TYPE		CUSTOMER DRAWING						
SCALE		1:1 SHEET 1 OF 1						
DRAWING NO.		W10000402						

DF

慈溪市凯峰电子有限公司
CIXI KAIFENG ELECTRONICS CO., LTD

REV.	DESCRIPTION	DATE	DRAFTER	APPROVER
A1	DWG.REL	2020.5.23	ZHANG	JIN

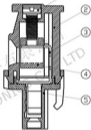
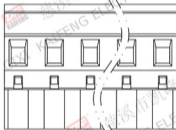
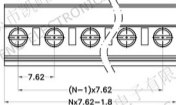
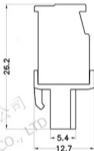

- Material
 - ØScrew : M2.5 steel, Zinc plated, -- slot type
 - ØHousing : PA66, UL94V-0
 - ØContact : Copper alloy, Tin plated
 - ØClamp : Copper alloy, Ni plated
 - ØCover : PA66, UL94V-0
- Electrical
 - UL IEC
 - Rated voltage : 300V 400V
 - Rated current : 15A 18A
 - Contact resistance : 20mΩ(Max)
 - Insulation resistance: 500MΩ/DC500V
 - Withstanding Voltage : AC2500V/1min
 - Wire range: 28-12AWG 2.5mm²
- Mechanical
 - Operating temperature: -40°C ~ +105°C
 - Soldering temperature: 250°C ±5/5sec
 - Torque: 0.4N.m (3.54Lb.in)
 - Strip length: 7-8mm
- RoHS compliance

HOW TO ORDER

KF2EDGKB-7.62-XXP-1 X-XXXXX



Pitch range		Nominal dimension range					PROJECTION
>0	>6	>10	>0	>30	>60	>100	0.1/1.0
-	-	-	-	-	-	-	<
±0.15	±0.20	±0.30	±0.30	±0.50	±0.70	±1.00	±Z
6	10	24	30	60	100	150	

UNIT	TITLE
mm	KF2EDGKB-7.62-XXP-1X
SHEET SIZE	SERIES
A4	KF2EDGKB

DRAWING TYPE	CUSTOMER DRAWING
SCALE	1:1 SHEET 1 OF 1
DRAWING NO.	W10000422



慈溪市凯峰电子有限公司
CIXI KAIFENG ELECTRONICS CO.,LTD

REV.	DESCRIPTION	DATE	DRAFTER	APPROVER
A1	DWG.REL	2020.5.23	ZHANG	JIN

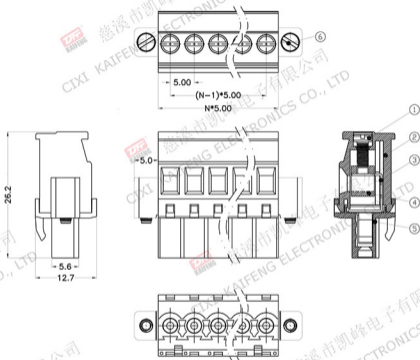

• Material

#Screw : M3.0 steel, Zinc plated, "—" slot type
 #Housing : PA66, UL94V-0
 #Contact : Copper alloy, Tin plated
 #Clamp : Copper alloy, Ni plated
 #Cover : PA66, UL94V-0
 #Screw : M2.5 steel, Zinc plated, "—" slot type

• Electrical

UL IEC
 Rated voltage : 300V 320V
 Rated current : 15A 18A
 Contact resistance : 20mΩ(Max)
 Insulation resistance : 500MΩ/DC500V
 Withstanding Voltage : AC2000V/1min
 Wire range : 28-12AWG 2.5mm²

• Mechanical

Operating temperature : -40℃ ~ +105℃
 Soldering temperature : 250℃ ±5/5sec
 Torque : 0.5N.m (4.43lb.in)
 Strip length : 7-8mm

• RoHS compliance

HOW TO ORDER

KF2EDGKBM-5.0-XXP-1 X-XXXXX

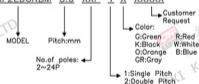

Pitch range		Nominal dimension range				PROJECTION	TITLE
>0	>6	>10	>0	>30	>60	>100	6.1/10
6	10	24	30	60	100	150	<
±0.15	±0.20	±0.30	±0.30	±0.50	±0.70	±1.00	±1.30
						±2°	
DRAWING TYPE		CUSTOMER DRAWING					
SCALE		1:1 SHEET 1 OF 1					
DRAWING NO.		W10000332					
UNIT		mm					
SHEET SIZE		A4					
SERIES		KF2EDGKBM					
TITLE		KF2EDGKBM-5.0-XXP-1X					

慈溪市凯峰电子有限公司
 CIXI KAIFENG ELECTRONICS CO., LTD

REV.	DESCRIPTION	DATE	DRAFTER	APPROVER
A1	DWG.REL	2020.5.23	ZHANG	JIN

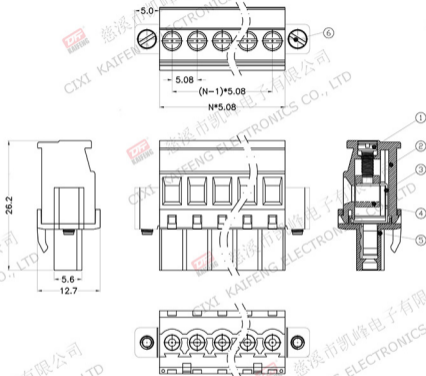

• Material
 @Screw : M3.0 steel, Zinc plated, "—" slot type
 @Housing : PA66, UL94V-0
 @Contact : Copper alloy, Tin plated
 @Clamp : Copper alloy, Ni plated
 @Cover : PA66, UL94V-0
 @Screw : M2.5 steel, Zinc plated, "—" slot type

• Electrical
 UL IEC
 Rated voltage : 300V 320V
 Rated current : 15A 18A
 Contact resistance : 20mΩ(Max)
 Insulation resistance : 500MΩ/DC500V
 Withstanding Voltage : AC2000V/1min
 Wire range : 28-12AWG 2.5mm²

• Mechanical
 Operating temperature : -40℃ ~ +105℃
 Soldering temperature : 250℃ ±5/5sec
 Torque : 0.5N.m (4.43Lb.in)
 Strip length : 7-8mm

• RoHS compliance

HOW TO ORDER

KF2FDGKBM-5.08-XXP-1 X-XXXXX



Pitch range	Nominal dimension range	PROJECTION
>0	>0	0.1/10
>6	>60	<
>10	>100	>150
8	10	24
30	60	100
30	60	100
±0.30	±0.50	±0.70
±0.30	±0.50	±1.00
±0.30	±0.50	±1.30
±0.30	±0.50	±2

PROJECTION

UNIT mm

SHEET SIZE A4

SERIES KF2FDGKBM

TITLE KF2FDGKBM-5.08-XXP-1X

DRAWING TYPE	CUSTOMER DRAWING
SCALE	1:1 SHEET 1 OF 1
DRAWING NO.	W10000352

慈溪市凯峰电子有限公司
 CIXI KAIFENG ELECTRONICS CO., LTD

REV.	DESCRIPTION	DATE	DRAFTER	APPROVER
A1	DWG.REL	2020.5.25	ZHANG	JIN

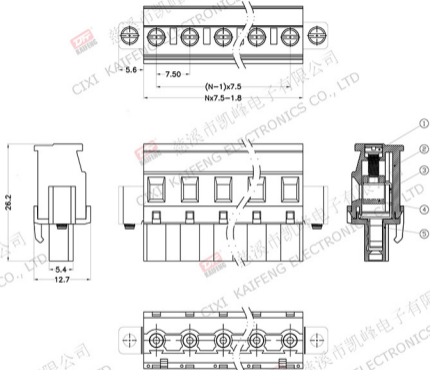

• Material
 @Screw : M2.5 steel, Zinc plated, "—" slot type
 @Housing : PA66, UL94V-0
 @Contact : Copper alloy, Tin plated
 @Clamp : Copper alloy, Ni plated
 @Cover : PA66, UL94V-0

• Electrical
 UL IEC
 Rated voltage : 300V 400V
 Rated current : 15A 18A
 Contact resistance : 20mΩ(Max)
 Insulation resistance : 500MΩ/DC500V
 Withstanding Voltage : AC2500V/1min
 Wire range : 28-12AWG 2.5mm²

• Mechanical
 Operating temperature: -40°C ~ +105°C
 Soldering temperature: 250°C ±5/5sec
 Torque : 0.4N.m (3.54Lb.in)
 Strip length: 7-8mm

• RoHS compliance

HOW TO ORDER
KF2EDGKBM-7.5-XXP-1 X-XXXXX



Pitch range	Nominal dimension range	PROJECTION	TITLE
>0	>0	UNIT	mm
>6	>30	SHEET SIZE	A4
>10	>60	SERIES	KF2EDGKBM
>15	>100	慈溪市凯峰电子有限公司 CIXI KAIFENG ELECTRONICS CO., LTD	
±0.15	±0.20	SCALE 1:1 SHEET 1 OF 1	
±0.30	±0.30	DRAWING NO. W10000412	

REV.	DESCRIPTION	DATE	DRAFTER	APPROVER
A1	DWG.REL	2020.5.23	ZHANG	JIN

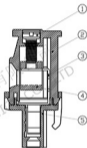
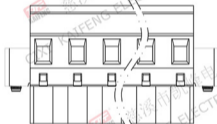
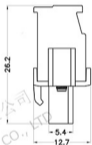
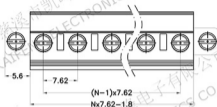

- Material
 - ①Screw : M2.5 steel, Zinc plated, "—" slot type
 - ②Housing : PA66, UL94V-0
 - ③Contact : Copper alloy, Tin plated
 - ④Clamp : Copper alloy, Ni plated
 - ⑤Cover : PA66, UL94V-0

- Electrical
 - UL IEC
 - Rated voltage : 300V 400V
 - Rated current : 15A 18A
 - Contact resistance : 20mΩ(Max)
 - Insulation resistance: 500MΩ/DC500V
 - Withstanding Voltage : AC2500V/1min
 - Wire range: 28-12AWG 2.5mm²

- Mechanical
 - Operating temperature: -40℃ ~ +105℃
 - Soldering temperature: 250℃ ±5/5sec
 - Torque: 0.4N.m (3.54Lb.in)
 - Strip length: 7-8mm

- RoHS compliance

HOW TO ORDER

KF2EDGKBM-7.62-XXP-1 X-XXXX



Pitch range	Nominal dimension range	PROJECTION	TITLE
>0	>0	0.1/10	KF2EDGKBM-7.62-XXP-1X
>6	>30	<	SHEET SIZE A4
8	10 24 30		SERIES KF2EDGKBM
±0.15	±0.20 ±0.30 ±0.30 ±0.50 ±0.70 ±1.00 ±1.30 ±2		
DRAWING TYPE CUSTOMER DRAWING		慈溪市凯峰电子有限公司 CIXI KAIFENG ELECTRONICS CO.,LTD	
SCALE 1:1 SHEET 1 OF 1			
DRAWING NO. W10000432			

REV.	DESCRIPTION	DATE	DRAFTER	APPROVER
A1	DWG.REL	2020.5.30	ZHANG	JIN

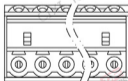
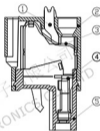
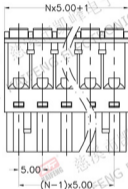
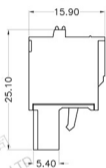

- Material
 - ⊙Button : PA66, UL94V-0
 - ⊙Housing : PA66, UL94V-0
 - ⊙Reed : Stainless steel
 - ⊙Contact : Copper alloy, Tin plated
 - ⊙Cover : PA66, UL94V-0

- Electrical
 - UL IEC
 - Rated voltage : 300V 320V
 - Rated current : 15A 20A
 - Contact resistance : 20mΩ(Max)
 - Insulation resistance : 500MΩ/DC500V
 - Withstanding Voltage : AC2000V/1min
 - Wire range : 28-14AWG 2.5mm²

- Mechanical
 - Operating temperature: -40°C ~ +105°C
 - Soldering temperature: 250°C ± 5/5sec
 - Strip length: 10-11mm

- RoHS compliance

HOW TO ORDER

KF2EDGKD-5.0-XXP-1 X-XXXXX



Pitch range		Nominal dimension range				PROJECTION	TITLE
>0	>6	>10	>0	>30	>60	>100	6.1/10
6	10	24	30	60	100	150	<
±0.15 (±0.20)		±0.30	±0.30	±0.50	±0.70	±1.00	±2
DRAWING TYPE		CUSTOMER DRAWING					
SCALE		1:1		SHEET		1 OF 1	
DRAWING NO.		W10000442					
UNIT							mm
SHEET SIZE							A4
SERIES							KF2EDGKD
TITLE							KF2EDGKD-5.0-XXP-1X

DF 慈溪市凯峰电子有限公司
CIXI KAIFENG ELECTRONICS CO., LTD

REV.	DESCRIPTION	DATE	DRAFTER	APPROVER
A1	DWG.REL	2020.5.30	ZHANG	JIN

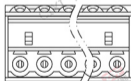
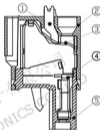
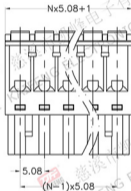
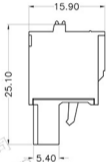

- Material
 - ⊙Button : PA66, UL94V-0
 - ⊙Housing : PA66, UL94V-0
 - ⊙Reed : Stainless steel
 - ⊙Contact : Copper alloy, Tin plated
 - ⊙Cover : PA66, UL94V-0
- Electrical
 - UL IEC
 - Rated voltage : 300V 320V
 - Rated current : 15A 20A
 - Contact resistance : 20mΩ(Max)
 - Insulation resistance : 500MΩ/DC500V
 - Withstanding Voltage : AC2000V/1min
 - Wire range : 28-14AWG 2.5mm²
- Mechanical
 - Operating temperature: -40℃ ~ +105℃
 - Soldering temperature: 250℃ ± 5/5sec
 - Strip length: 10-11mm
- RoHS compliance

HOW TO ORDER

KF2EDGKD-5.08-XXP-1 X-XXXX



Pitch range	Nominal dimension range	PROJECTION
>0	>0	6.1/10
6	30	<
±0.15 (±0.20)	±0.30 (±0.50)	±2

UNIT	TITLE
mm	KF2EDGKD-5.08-XXP-1X
SHEET SIZE	SERIES
A4	KF2EDGKD

DRAWING TYPE	CUSTOMER DRAWING
SCALE	1:1 SHEET 1 OF 1
DRAWING NO.	W10000462

DF 慈溪市凯峰电子有限公司
CIXI KAIFENG ELECTRONICS CO., LTD

REV.	DESCRIPTION	DATE	DRAFTER	APPROVER
A1	DWG.REL	2020.5.30	ZHANG	JIN

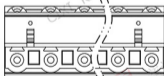
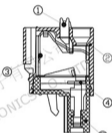
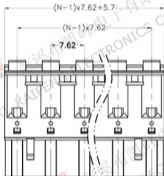
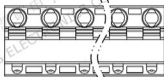
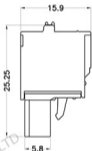

- Material
 - ØButton : PA66, UL94V-0
 - ØHousing : PA66, UL94V-0
 - ØReed : Stainless steel
 - ØContact : Copper alloy, Tin plated
 - ØCover : PA66, UL94V-0

- Electrical
 - UL IEC
 - Rated voltage : 300V 400V
 - Rated current : 15A 20A
 - Contact resistance : 20mΩ(Max)
 - Insulation resistance : 500MΩ/DC500V
 - Withstanding Voltage : AC2000V/1min
 - Wire range : 28-14AWG 2.5mm²

- Mechanical
 - Operating temperature : -40℃~+105℃
 - Soldering temperature : 250℃±5/5sec
 - Strip length : 10-11mm

- RoHS compliance

HOW TO ORDER

KF2EDGKD-7.62-XXP-1 X-XXXX



Pitch range		Nominal dimension range				PROJECTION	
>0	>6	>10	>0	>30	>60	>100	6.1/10
6	10	24	30	60	100	150	<
±0.15 (±0.20)		±0.30	±0.50	±0.50	±0.70	±1.00	±2

PROJECTION

UNIT

mm

TITLE

KF2EDGKD-7.62-XXP-1X

SHEET SIZE

A4

SERIES

KF2EDGKD

DRAWING TYPE CUSTOMER DRAWING

SCALE 1:1 SHEET 1 OF 1

DRAWING NO. W10000482

DF

慈溪市凯峰电子有限公司

CIXI KAIFENG ELECTRONICS CO., LTD

REV.	DESCRIPTION	DATE	DRAFTER	APPROVER
A1	DWG.REL	2020.5.30	ZHANG	JIN

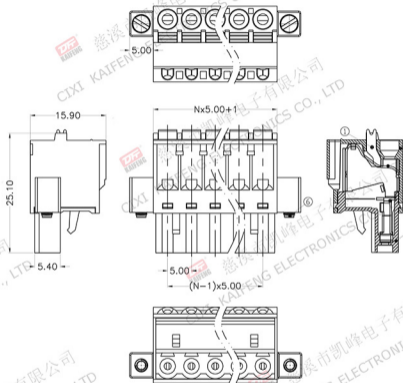

- Material
 - ⊙Button : PA66, UL94V-0
 - ⊙Housing : PA66, UL94V-0
 - ⊙Reed : Stainless steel
 - ⊙Contact : Copper alloy, Tin plated
 - ⊙Cover : PA66, UL94V-0
 - ⊙Screw : M2.5 steel, Zinc plated
- Electrical
 - UL IEC
 - Rated voltage : 300V 320V
 - Rated current : 15A 20A
 - Contact resistance : 20mΩ(Max)
 - Insulation resistance : 500MΩ/DC500V
 - Withstanding Voltage : AC2000V/1min
 - Wire range : 28-14AWG 2.5mm²
- Mechanical
 - Operating temperature: -40℃~+105℃
 - Soldering temperature: 250℃±5/5sec
 - Strip length: 10-11mm

• RoHS compliance
HOW TO ORDER

KF2EDGKDM-5.0-XXP-1 X-XXXXX

MODEL Pitch:mm

No. of poles: 2~24P

Customer Request

Color: G:Green R:Red
K:Black W:White
O:Orange B:Blue
GR:Gray

1:Single Pitch
2:Double Pitch

Pitch range	Nominal dimension range	PROJECTION	TITLE
$\times 0$ $\times 6$ $\times 10$ $\times 0$ $\times 30$ $\times 60$ $\times 100$ 6 10 24 30 60 100 150	$\times 0$ $\times 30$ $\times 60$ $\times 100$ $\times 150$ 60.15 60.20 60.30 60.30 60.50 60.70 61.00 61.30 61.7	0.1/10 <	KF2EDGKDM-5.0-XXP-1X SHEET SIZE A4 SERIES KF2EDGKDM
DRAWING TYPE CUSTOMER DRAWING		慈溪市凯峰电子有限公司 CIXI KAIFENG ELECTRONICS CO., LTD	
SCALE 1:1 SHEET 1 OF 1		DRAWING NO. W10000452	

REV.	DESCRIPTION	DATE	DRAFTER	APPROVER
A1	DWG.REL	2020.5.30	ZHANG	JIN

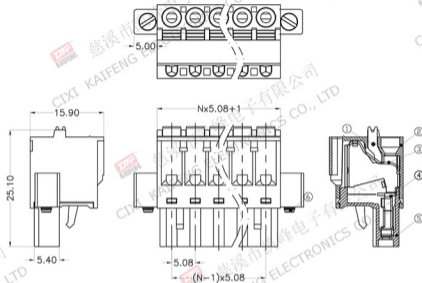

- Material
 - ØButton : PA66, UL94V-0
 - ØHousing : PA66, UL94V-0
 - ØReed : Stainless steel
 - ØContact : Copper alloy, Tin plated
 - ØCover : PA66, UL94V-0
 - ØScrew : M2.5 steel, Zinc plated

- Electrical
 - UL IEC
 - Rated voltage : 300V 320V
 - Rated current : 15A 20A
 - Contact resistance : 20mΩ(Max)
 - Insulation resistance : 500MΩ/DC500V
 - Withstanding Voltage : AC2000V/1min
 - Wire range : 28-14AWG 2.5mm²

- Mechanical
 - Operating temperature: -40℃~+105℃
 - Soldering temperature: 250℃±5/5sec
 - Strip length: 10-11mm

- RoHS compliance

HOW TO ORDER

KF2EDGKDM-5.08-XXP-1 X-XXXXX



Pitch range		Nominal dimension range				PROJECTION			
>0	>6	>10	>0	>30	>60	>100	0.1/10		
6	10	24	30	60	100	150	<		
±0.15		±0.20	±0.30	±0.30	±0.50	±0.70	±1.00	±1.30	±2

UNIT	TITLE
mm	KF2EDGKDM-5.08-XXP-1X
SHEET SIZE	SERIES
A4	KF2EDGKDM

DRAWING TYPE	CUSTOMER DRAWING
SCALE	1:1
SHEET	1 OF 1
DRAWING NO.	W10000472

DF 慈溪市凯峰电子有限公司
CIXI KAIFENG ELECTRONICS CO., LTD

REV.	DESCRIPTION	DATE	DRAFTER	APPROVER
A1	DWG.REL	2020.5.30	ZHANG	JIN

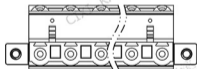
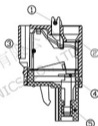
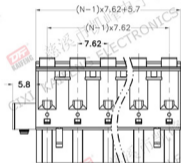

- Material
 - ØButton : PA66, UL94V-0
 - ØHousing : PA66, UL94V-0
 - ØReed : Stainless steel
 - ØContact : Copper alloy, Tin plated
 - ØCover : PA66, UL94V-0
 - ØScrew : M2.5 steel, Zinc plated

- Electrical
 - UL IEC
 - Rated voltage : 300V 400V
 - Rated current : 15A 20A
 - Contact resistance : 20mΩ(Max)
 - Insulation resistance : 500MΩ/DC500V
 - Withstanding Voltage : AC2000V/1min
 - Wire range : 28-14AWG 2.5mm²

- Mechanical
 - Operating temperature: -40°C ~ +105°C
 - Soldering temperature: 250°C ± 5 / 5sec
 - Strip length: 10-11mm

- RoHS compliance

HOW TO ORDER

KF2EDGKDM-7.62-XXP-1 X-XXXXX

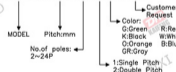

Pitch range	Nominal dimension range	PROJECTION
>0 >6 >10	>0 >30 >60 >100	6.1/10
6 10 24	30 60 100 150	<
±0.15 ±0.20 ±0.30	±0.30 ±0.50 ±0.70 ±1.00 ±1.30 ±2	

UNIT	TITLE
mm	KF2EDGKDM-7.62-XXP-1X
SHEET SIZE	SERIES
A4	KF2EDGKDM

DRAWING TYPE	CUSTOMER DRAWING
SCALE	1:1 SHEET 1 OF 1
DRAWING NO.	W10000492

DF 慈溪市凯峰电子有限公司
CIXI KAIFENG ELECTRONICS CO., LTD