

REV.	DESCRIPTION	DATE	DRAFTER	APPROVER
A1	DWG.REL	2020.6.02	ZHANG	JIN

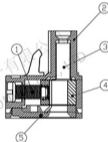
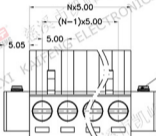
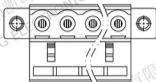

- Material
- ①Screws :M3.0 steel, Zinc plated, "-" slot type
- ②Housing : PA66, UL94V-0
- ③Contact : Copper alloy, Tin plated
- ④Clamp : Copper alloy, Ni plated
- ⑤Cover : PA66, UL94V-0
- ⑥Screw :M2.5 steel, Zinc plated, "-" slot type

- Electrical
- UL IEC
- Rated voltage : 300V 320V
- Rated current : 15A 20A
- Contact resistance : 20mΩ(Max)
- Insulation resistance : 500MΩ/DC500V
- Withstanding Voltage : AC2000V/1min
- Wire range : 28-12AWG 2.5mm²

- Mechanical
- Operating temperature: -40℃~+105℃
- Soldering temperature: 250℃±5/5sec
- Torque : 0.5N.m (4.43lbf.in)
- Strip length : 7-8mm

- RoHS compliance

HOW TO ORDER

KF2EDGM-X-5.0-XXP-1 X-XXXXX



Pitch range		Nominal dimension range				PROJECTION		
>0	>6	>10	>0	>30	>60	>100	>150	0.1/10
6	10	24	30	60	100	150	≥150	≤
±0.15(±0.20)		±0.30	±0.30	±0.50	±0.70	±1.00	±1.30	±2

UNIT	TITLE
mm	KF2EDGM-X-5.0-XXP-1X
SHEET SIZE	SERIES
A4	KF2EDGM-X

DRAWING TYPE	CUSTOMER DRAWING
SCALE	1:1 SHEET 1 OF 1
DRAWING NO.	W10000692

DF 慈溪市凯峰电子有限公司
CIXI KAIFENG ELECTRONICS CO.,LTD

REV.	DESCRIPTION	DATE	DRAWER	APPROVER
A1	DWG.REL	2020.6.02	ZHANG	JIN

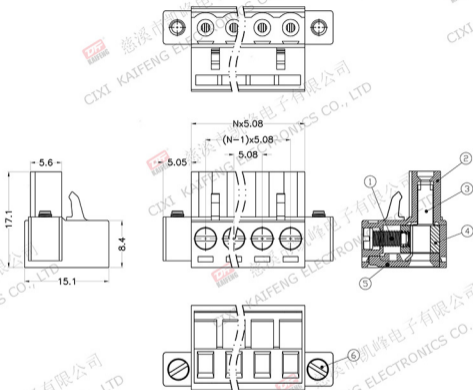

- Material
 - ①Screw :M3.0 steel, Zinc plated, "-" slot type
 - ②Housing : PA66, UL94V-0
 - ③Contact : Copper alloy, Tin plated
 - ④Clamp : Copper alloy, Ni plated
 - ⑤Cover : PA66, UL94V-0
 - ⑥Screw :M2.5 steel, Zinc plated, "-" slot type

- Electrical
 - UL IEC
 - Rated voltage : 300V 320V
 - Rated current : 15A 20A
 - Contact resistance : 20mΩ(Max)
 - Insulation resistance: 500MΩ/DC500V
 - Withstanding Voltage : AC2000V/1min
 - Wire range : 28-12AWG 2.5mm²

- Mechanical
 - Operating temperature: -40°C ~ +105°C
 - Soldering temperature: 250°C ± 5/5sec
 - Torque : 0.5N.m (4.43lb.in)
 - Strip length: 7-8mm

- RoHS compliance

HOW TO ORDER

KF2EDGM-X-5.08-XXP-1 X-XXXXX

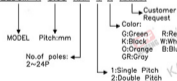

Pitch range	Nominal dimension range	PROJECTION	TITLE
>0	>0	0.1/10	KF2EDGM-X-5.08-XXP-1X
>6	>30	<	SHEET SIZE
6-10	24-30		A4
>10	>60		SERIES
10-15	60-100		KF2EDGM-X
>15	>150		
15-20	100-150		
>20	>150		
20-25	150-200		
>25	>200		
25-30	200-250		
>30	>250		
30-35	250-300		
>35	>300		
35-40	300-350		
>40	>350		
40-45	350-400		
>45	>400		
45-50	400-450		
>50	>450		
50-55	450-500		
>55	>500		
55-60	500-550		
>60	>550		
60-65	550-600		
>65	>600		
65-70	600-650		
>70	>650		
70-75	650-700		
>75	>700		
75-80	700-750		
>80	>750		
80-85	750-800		
>85	>800		
85-90	800-850		
>90	>850		
90-95	850-900		
>95	>900		
95-100	900-950		
>100	>950		
100-105	950-1000		
>105	>1000		
105-110	1000-1050		
>110	>1050		
110-115	1050-1100		
>115	>1100		
115-120	1100-1150		
>120	>1150		
120-125	1150-1200		
>125	>1200		
125-130	1200-1250		
>130	>1250		
130-135	1250-1300		
>135	>1300		
135-140	1300-1350		
>140	>1350		
140-145	1350-1400		
>145	>1400		
145-150	1400-1450		
>150	>1450		
150-155	1450-1500		
>155	>1500		
155-160	1500-1550		
>160	>1550		
160-165	1550-1600		
>165	>1600		
165-170	1600-1650		
>170	>1650		
170-175	1650-1700		
>175	>1700		
175-180	1700-1750		
>180	>1750		
180-185	1750-1800		
>185	>1800		
185-190	1800-1850		
>190	>1850		
190-195	1850-1900		
>195	>1900		
195-200	1900-1950		
>200	>1950		
200-205	1950-2000		
>205	>2000		
205-210	2000-2050		
>210	>2050		
210-215	2050-2100		
>215	>2100		
215-220	2100-2150		
>220	>2150		
220-225	2150-2200		
>225	>2200		
225-230	2200-2250		
>230	>2250		
230-235	2250-2300		
>235	>2300		
235-240	2300-2350		
>240	>2350		
240-245	2350-2400		
>245	>2400		
245-250	2400-2450		
>250	>2450		
250-255	2450-2500		
>255	>2500		
255-260	2500-2550		
>260	>2550		
260-265	2550-2600		
>265	>2600		
265-270	2600-2650		
>270	>2650		
270-275	2650-2700		
>275	>2700		
275-280	2700-2750		
>280	>2750		
280-285	2750-2800		
>285	>2800		
285-290	2800-2850		
>290	>2850		
290-295	2850-2900		
>295	>2900		
295-300	2900-2950		
>300	>2950		
300-305	2950-3000		
>305	>3000		
305-310	3000-3050		
>310	>3050		
310-315	3050-3100		
>315	>3100		
315-320	3100-3150		
>320	>3150		
320-325	3150-3200		
>325	>3200		
325-330	3200-3250		
>330	>3250		
330-335	3250-3300		
>335	>3300		
335-340	3300-3350		
>340	>3350		
340-345	3350-3400		
>345	>3400		
345-350	3400-3450		
>350	>3450		
350-355	3450-3500		
>355	>3500		
355-360	3500-3550		
>360	>3550		
360-365	3550-3600		
>365	>3600		
365-370	3600-3650		
>370	>3650		
370-375	3650-3700		
>375	>3700		
375-380	3700-3750		
>380	>3750		
380-385	3750-3800		
>385	>3800		
385-390	3800-3850		
>390	>3850		
390-395	3850-3900		
>395	>3900		
395-400	3900-3950		
>400	>3950		
400-405	3950-4000		
>405	>4000		
405-410	4000-4050		
>410	>4050		
410-415	4050-4100		
>415	>4100		
415-420	4100-4150		
>420	>4150		
420-425	4150-4200		
>425	>4200		
425-430	4200-4250		
>430	>4250		
430-435	4250-4300		
>435	>4300		
435-440	4300-4350		
>440	>4350		
440-445	4350-4400		
>445	>4400		
445-450	4400-4450		
>450	>4450		
450-455	4450-4500		
>455	>4500		
455-460	4500-4550		
>460	>4550		
460-465	4550-4600		
>465	>4600		
465-470	4600-4650		
>470	>4650		
470-475	4650-4700		
>475	>4700		
475-480	4700-4750		
>480	>4750		
480-485	4750-4800		
>485	>4800		
485-490	4800-4850		
>490	>4850		
490-495	4850-4900		
>495	>4900		
495-500	4900-4950		
>500	>4950		



慈溪市凯峰电子有限公司
CIXI KAIFENG ELECTRONICS CO.,LTD

REV.	DESCRIPTION	DATE	DRAFTER	APPROVER
A1	DWG.REL	2020.6.02	ZHANG	JIN

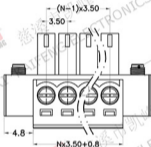
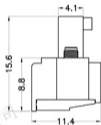
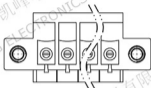

- Material
 - ①Screw : M2.0 steel, Zinc plated, *-* slot type
 - ②Housing : PA66, UL94V-0
 - ③Contact : Copper alloy, Tin plated
 - ④Clamp : Copper alloy, Ni plated
 - ⑤Cover : PA66, UL94V-0
 - ⑥Screw : M2.5 steel, Zinc plated, *-* slot type

- Electrical
 - UL IEC
 - Rated voltage : 300V 250V
 - Rated current : 8A 7A
 - Contact resistance : 20mΩ(Max)
 - Insulation resistance : 500MΩ/DC500V
 - Withstanding Voltage : AC1500V/1min
 - Wire range : 2B-16AWG 0.5-1.5mm²

- Mechanical
 - Operating temperature: -40℃~+105℃
 - Soldering temperature: 250℃±5/5sec
 - Torque : 0.2N.m (1.77Lb.in)
 - Strip length : 6-7mm

- RoHS compliance

HOW TO ORDER
KF2EDGM-Y-3.5-XXP-1 X-XXXXX



Pitch range		Nominal dimension range				PROJECTION	TITLE			
>0	>6	>10	>0	>30	>60	>100	>150	UNIT	mm	KF2EDGM-Y-3.5-XXP-1X
6	10	24	30	60	100	150	>150	SHEET SIZE	A4	SERIES KF2EDGM-Y
±0.15	±0.20	±0.30	±0.30	±0.50	±0.70	±1.00	±1.30	DRAWING TYPE CUSTOMER DRAWING		
SCALE		1:1		SHEET		1 OF 1		慈溪市凯峰电子有限公司		
DRAWING NO.		W10000702						CIXI KAIFENG ELECTRONICS CO.,LTD		

REV.	DESCRIPTION	DATE	DRAFTER	APPROVER
A1	DWG.REL	2020.6.02	ZHANG	JIN

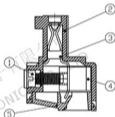
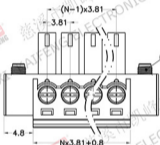
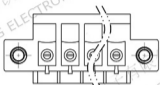

- Material
 - ①Screw : M2.0 steel,Zinc plated, "-" slot type
 - ②Housing : PA66, UL94V-0
 - ③Contact : Copper alloy,Tin plated
 - ④Clamp : Copper alloy, Ni plated
 - ⑤Cover : PA66, UL94V-0
 - ⑥Screw : M2.5 steel,Zinc plated, "-" slot type

- Electrical
 - UL IEC
 - Rated voltage : 300V 250V
 - Rated current : 8A 7A
 - Contact resistance : 20mΩ(Max)
 - Insulation resistance: 500MΩ/DC500V
 - Withstanding Voltage : AC1500V/1min
 - Wire range : 28-16AWG 0.5-1.5mm²

- Mechanical
 - Operating temperature:-40℃~+105℃
 - Soldering temperature:250℃±5/5sec
 - Torque : 0.2N.m (1.77Lb.in)
 - Strip length: 6-7mm

- RoHS compliance

HOW TO ORDER

KF2EDGM-Y-3.81-XXP-1 X-XXXXX

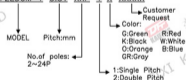

Pitch range		Nominal dimension range				PROJECTION	TITLE
>0	>6	>10	>0	>30	>60	>100	6.1/10
6	10	24	30	60	100	150	<
±0.15	±0.20	±0.30	±0.30	±0.50	±0.70	±1.00	±1.30
							±2
DRAWING TYPE		CUSTOMER DRAWING					
SCALE		1:1 SHEET 1 OF 1					
DRAWING NO.		W10000732					

DF

慈溪市凯峰电子有限公司
CIXI KAIFENG ELECTRONICS CO.,LTD

REV.	DESCRIPTION	DATE	DRAFTER	APPROVER
A1	DWG.REL	2020.6.02	ZHANG	JIN

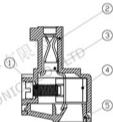
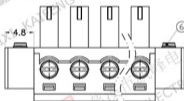
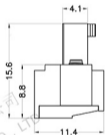
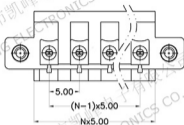

- Material
 - ①Screws : M2.0 steel, Zinc plated, "—" slot type
 - ②Housing : PA66, UL94V-0
 - ③Contact : Copper alloy, Tin plated
 - ④Clamp : Copper alloy, Ni plated
 - ⑤Cover : PA66, UL94V-0
 - ⑥Screw : M2.5 steel, Zinc plated, "—" slot type

- Electrical
 - UL IEC
 - Rated voltage : 300V 320V
 - Rated current : 8A 7A
 - Contact resistance : 20mΩ(Max)
 - Insulation resistance : 500MΩ/DC500V
 - Withstanding Voltage : AC2000V/1min
 - Wire range : 28-16AWG 0.5-1.5mm²

- Mechanical
 - Operating temperature: -40℃~+105℃
 - Soldering temperature: 250℃±5/Ssec
 - Torque : 0.2N.m (1.77Lb.in)
 - Strip length : 5-6mm

- RoHS compliance

HOW TO ORDER

KF2EDGM-Y-5.0-XXP-1 X-XXXXX



Pitch range		Nominal dimension range				PROJECTION
>0	>6	>10	>15	>20	>100	0.1/10
6	10	24	30	60	100 150	<
±0.15	±0.20	±0.30	±0.30	±0.50	±0.70	±1.30
						±2



UNIT mm

SHEET SIZE A4

SERIES KF2EDGM-Y

TITLE KF2EDGM-Y-5.0-XXP-1X

DRAWING TYPE	CUSTOMER DRAWING
SCALE	1:1 SHEET 1 OF 1
DRAWING NO.	W10000762



慈溪市凯峰电子有限公司
CIXI KAIFENG ELECTRONICS CO., LTD

REV.	DESCRIPTION	DATE	DRAFTER	APPROVER
A1	DWG.REL	2020.6.02	ZHANG	JIN

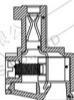
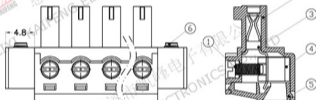
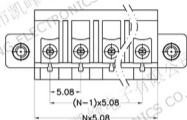

- Material
 - ①Screw : M2.0 steel, Zinc plated, "—" slot type
 - ②Housing : PA66, UL94V-0
 - ③Contact : Copper alloy, Tin plated
 - ④Clamp : Copper alloy, Ni plated
 - ⑤Cover : PA66, UL94V-0
 - ⑥Screw : M2.5 steel, Zinc plated, "—" slot type

- Electrical
 - UL IEC
 - Rated voltage : 300V 320V
 - Rated current : 8A 7A
 - Contact resistance : 20mΩ(Max)
 - Insulation resistance : 500MΩ/DC500V
 - Withstanding Voltage : AC2000V/1min
 - Wire range : 28-16AWG 0.5-1.5mm²

- Mechanical
 - Operating temperature: -40°C ~ +105°C
 - Soldering temperature: 250°C ±5/5sec
 - Torque : 0.2N.m (1.77Lb.in)
 - Strip length : 5-6mm

- RoHS compliance

HOW TO ORDER

KF2EDGM-Y-5.08-XXP-1 X-XXXXX



Pitch range		Nominal dimension range				PROJECTION	TITLE
>0	>6	>10	>0	>30	>60	>100	6.1/10
8	10	24	30	60	100	150	<
±0.15 (±0.20)		±0.30	±0.30	±0.50	±0.70	±1.00	±1.30
DRAWING TYPE		CUSTOMER DRAWING					
SCALE		1:1 SHEET 1 OF 1					
DRAWING NO.		W10000792					
UNIT							mm
SHEET SIZE							A4
SERIES							KF2EDGM-Y
慈溪市凯峰电子有限公司 CIXI KAIFENG ELECTRONICS CO.,LTD							