

REV.	DESCRIPTION	DATE	DRAFTER	APPROVER
A1	DWG.REL	2020.6.02	ZHANG	JIN

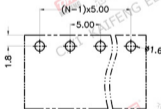
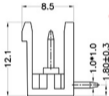
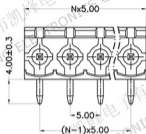

P.C.B. LAYOUT

- Material
  - ⊙Housing : PA66, UL94V-0
  - ⊙Pin header : Copper alloy, Tin plated
- Electrical
  - UL IEC
  - Rated voltage : 300V 320V
  - Rated current : 15A 20A
  - Contact resistance : 20mΩ(Max)
  - Insulation resistance: 500MΩ/DC500V
  - Withstanding Voltage : AC2000V/1min
- Mechanical
  - Operating temperature: -40°C ~ +105°C
  - Soldering temperature: 250°C ±5/5sec
- RoHS compliance

HOW TO ORDER

KF2EDGR-X-5.0-XXP-1 X-XXXXX

MODEL Pitch:mm

No. of poles:

2~24P

Customer Request  
 Color:  
 G:Green R:Red  
 K:Black W:White  
 O:Orange B:Blue  
 GR:Gray  
 1:Single Pitch  
 2:Double Pitch

Pitch range	Nominal dimension range	PROJECTION	TITLE
>0	>6	6.1/10	KF2EDGR-X-5.0-XXP-1X
>10	>30	<	SHEET SIZE A4
±0.15	±0.20	±0.30	SERIES KF2EDGR-X
±0.30	±0.50	±0.70	
±1.00	±1.30	±2	
DRAWING TYPE CUSTOMER DRAWING		慈溪市凯峰电子有限公司 CIXI KAIFENG ELECTRONICS CO.,LTD	
SCALE 1:1 SHEET 1 OF 1			
DRAWING NO. W10000662			

REV.	DESCRIPTION	DATE	DRAFTER	APPROVER
A1	DWG.REL	2020.6.02	ZHANG	JIN

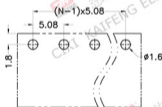
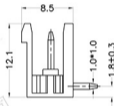
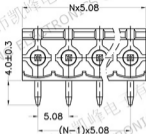

P.C.B.LAYOUT

- Material
  - ①Housing : PA66, UL94V-0
  - ②Pin header : Copper alloy, Tin plated
- Electrical
  - UL IEC
  - Rated voltage : 300V 320V
  - Rated current : 15A 20A
  - Contact resistance : 20mΩ(Max)
  - Insulation resistance : 500MΩ/DC500V
  - Withstanding Voltage : AC2000V/1min
- Mechanical
  - Operating temperature: -40℃~+105℃
  - Soldering temperature: 250℃±5/5sec
- RoHS compliance

HOW TO ORDER

KF2EDGR-X-5.08-XXP-1 X-XXXXX

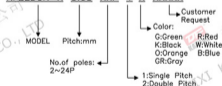

Pitch range	Nominal dimension range	PROJECTION	UNIT	TITLE
>0	>0	0.1/10	mm	KF2EDGR-X-5.08-XXP-1X
6	60	<	A4	SERIES KF2EDGR-X
CUSTOMER DRAWING		慈溪市凯峰电子有限公司 CIXI KAIFENG ELECTRONICS CO.,LTD		
SCALE	1:1 SHEET 1 OF 1			
DRAWING NO.	W10000612			

REV.	DESCRIPTION	DATE	DRAFTER	APPROVER
A1	DWG.REL	2020.5.18	ZHANG	JIN

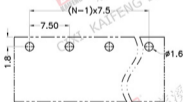
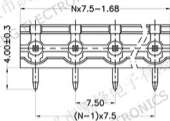

P.C.B.LAYOUT

- Material  
 ⌀Housing : PA66, UL94V-0  
 ⌀Pin header : Copper alloy, Tin plated
- Electrical  
 UL IEC  
 Rated voltage : 300V 400V  
 Rated current : 15A 20A  
 Contact resistance : 20mΩ(Max)  
 Insulation resistance: 500MΩ/DC500V  
 Withstanding Voltage : AC2500V/1min
- Mechanical  
 Operating temperature: -40°C ~ +105°C  
 Soldering temperature: 250°C ±5/5sec
- RoHS compliance

HOW TO ORDER

KF2EDGR-X-7.5-XXP-1 X-XXXX



Pitch range	Nominal dimension range	PROJECTION	TITLE
>0	>0	0.1/10	KF2EDGR-X-7.5-XXP-1X
6	60	<	SHEET SIZE A4
±0.15(±0.20)	±0.30(±0.50)	±1.30	SERIES KF2EDGR-X
DRAWING TYPE CUSTOMER DRAWING		慈溪市凯峰电子有限公司 CIXI KAIFENG ELECTRONICS CO.,LTD	
SCALE	1:1 SHEET 1 OF 1		
DRAWING NO.	W10000092		

REV.	DESCRIPTION	DATE	DRAFTER	APPROVER
A1	DWG.REL	2020.5.20	ZHANG	JIN

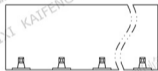
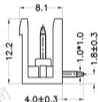
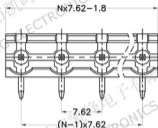

P.C.B.LAYOUT

- Material  
 ○ Housing : PA66, UL94V-0  
 ○ Pin header : Copper alloy, Tin plated
- Electrical IEC  
 Rated voltage : 300V 400V  
 Rated current : 15A 20A  
 Contact resistance : 20mΩ(Max)  
 Insulation resistance : 500MΩ/DC500V  
 Withstanding Voltage : AC2500V/1min
- Mechanical  
 Operating temperature : -40°C ~ +105°C  
 Soldering temperature : 250°C ± 5/5sec
- RoHS compliance

HOW TO ORDER

KF2EDGR-X-7.62-XXP-1 X-XXXXX

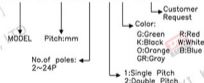

Pitch range		Nominal dimension range				PROJECTION	
>0	>6	>10	>0	>30	>60	>100	6.1/10
6	10	24	30	60	100	150	<
±0.15	±0.20	±0.30	±0.30	±0.50	±0.70	±1.00	±2

UNIT	TITLE
mm	KF2EDGR-X-7.62-XXP-1X
SHEET SIZE	SERIES
A4	KF2EDGR-X

DRAWING TYPE	CUSTOMER DRAWING
SCALE	1:1 SHEET 1 OF 1
DRAWING NO.	W10000172

**DF** 慈溪市凯峰电子有限公司  
CIXI KAIFENG ELECTRONICS CO., LTD

REV.	DESCRIPTION	DATE	DRAFTER	APPROVER
A1	DWG.REL	2020.6.08	ZHANG	JIN

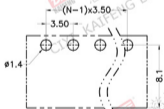
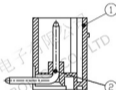
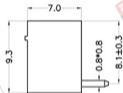
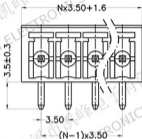

P.C.B. LAYOUT

- Material
  - ①Housing : PA66, UL94V-0
  - ②Pin header : Copper alloy, Tin plated
- Electrical
 

UL	IEC
Rated voltage : 300V	250V
Rated current : 8A	7A
Contact resistance : 20mΩ(Max)	
Insulation resistance : 500MΩ/DC500V	
Withstanding Voltage : AC1500V/1min	
- Mechanical
  - Operating temperature: -40°C ~ +105°C
  - Soldering temperature: 250°C ± 5/5sec
- RoHS compliance

HOW TO ORDER

KF2EDGR-Y-3.5-XXP-1 X-XXXXX



Pitch range	Nominal dimension range	PROJECTION
>0	>0	0.1/10
>6	>30	<
>10	>60	>100
6	10	24
30	60	100
150	300	150
150	300	150

UNIT	TITLE
mm	KF2EDGR-Y-3.5-XXP-1X
SHEET SIZE	SERIES
A4	KF2EDGR-Y

DRAWING TYPE	CUSTOMER DRAWING
SCALE	1:1 SHEET 1 OF 1
DRAWING NO.	W10000832

**DF** 慈溪市凯峰电子有限公司  
CIXI KAIFENG ELECTRONICS CO., LTD

REV	DESCRIPTION	DATE	DRAFTER	APPROVER
A1	DWG.REL	2020.6.08	ZHANG	JIN

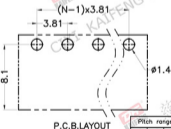
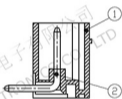
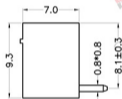
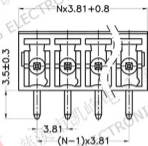

P.C.B.LAYOUT

- Material  
 ØHousing : PA66, UL94V-0  
 ØPin header : Copper alloy, Tin plated
- Electrical  
 UL IEC  
 Rated voltage : 300V 250V  
 Rated current : 8A 7A  
 Contact resistance : 20mΩ(Max)  
 Insulation resistance: 500MΩ/DC500V  
 Withstanding Voltage : AC1500V/1min
- Mechanical  
 Operating temperature: -40℃~+105℃  
 Soldering temperature: 250℃±5/5sec
- RoHS compliance

HOW TO ORDER

KF2EDGR-Y-3.81-XXP-1 X-XXXXX



Pitch range	Nominal dimension range	PROJECTION	TITLE	
≥0	>6	0.1/10	KF2EDGR-Y-3.81-XXP-1X	
~	>10	UNIT		mm
~	10	≤	SHEET SIZE	A4
±0.15	±0.20	±0.30	SERIES	KF2EDGR-Y
±0.30	±0.50	±0.70	DRAWING TYPE	CUSTOMER DRAWING
±1.00	±1.30	±2	SCALE	1:1 SHEET 1 OF 1
			DRAWING NO.	W10000872

**DF** 慈溪市凯峰电子有限公司  
CIXI KAIFENG ELECTRONICS CO.,LTD

REV.	DESCRIPTION	DATE	DRAFTER	APPROVER
A1	DWG.REL	2020.6.08	ZHANG	JIN

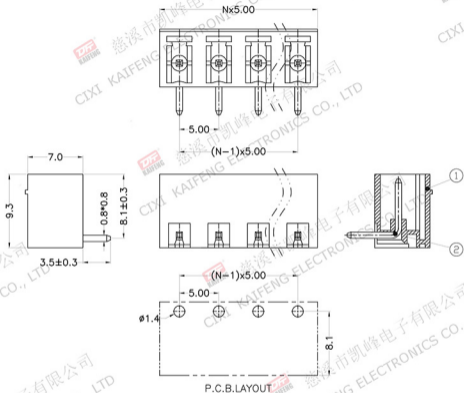

- Material
  - ØHousing : PA66, UL94V-0
  - ØPin header : Copper alloy, Tin plated
- Electrical
  - UL IEC
  - Rated voltage 300V 320V
  - Rated current : 8A 7A
  - Contact resistance : 20mΩ(Max)
  - Insulation resistance : 500MΩ/DC500V
  - Withstanding Voltage : AC2000V/1min
- Mechanical
  - Operating temperature: -40°C~+105°C
  - Soldering temperature: 250°C±5/5sec
- RoHS compliance

#### HOW TO ORDER

KF2EDGR-Y-5.0-XXP-1 X-XXXX



Pitch range	Nominal dimension range	PROJECTION
>0	>0	0.1/10
6	30	<
±0.15(±0.20)	±0.30(±0.50)	±2

UNIT	TITLE
mm	KF2EDGR-Y-5.0-XXP-1X
SHEET SIZE	SERIES
A4	KF2EDGR-Y

DRAWING TYPE	CUSTOMER DRAWING
SCALE	1:1 SHEET 1 OF 1
DRAWING NO.	W10000902

**DF** 慈溪市凯峰电子有限公司  
CIXI KAIFENG ELECTRONICS CO.,LTD

REV.	DESCRIPTION	DATE	DRAFTER	APPROVER
A1	DWG.REL	2020.6.08	ZHANG	JIN

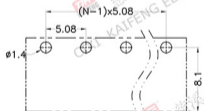
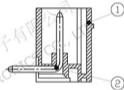
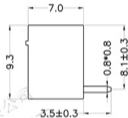
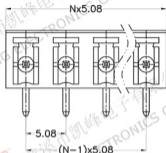

P.C.B.LAYOUT

- Material
  - Housing : PA66, UL94V-0
  - Pin header : Copper alloy, Tin plated
- Electrical
  - UL IEC
  - Rated voltage 300V 320V
  - Rated current : 8A 7A
  - Contact resistance : 20mΩ(Max)
  - Insulation resistance : 500MΩ/DC500V
  - Withstanding Voltage : AC2000V/1min
- Mechanical
  - Operating temperature: -40℃~+105℃
  - Soldering temperature: 250℃±5/5sec
- RoHS compliance

HOW TO ORDER

KF2EDGR-Y-5.08-XXP-1 X-XXXXX

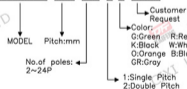

Pitch range

>0	>6	>10	>0	>30	>60	>100	>150	6.1/10
6	10	24	30	60	100	150	≥	
±0.15	±0.20	±0.30	±0.30	±0.50	±0.70	±1.00	±1.30	±2

CUSTOMER DRAWING

SCALE 1:1 SHEET 1 OF 1

DRAWING NO. W10000932

PROJECTION

UNIT mm

SHEET SIZE A4

SERIES KF2EDGR-Y

TITLE KF2EDGR-Y-5.08-XXP-1X



慈溪市凯峰电子有限公司  
CIXI KAIFENG ELECTRONICS CO.,LTD