

REV.	DESCRIPTION	DATE	DRAFTER	APPROVER
A1	DWG.REL	2020.5.20	ZHANG	JIN

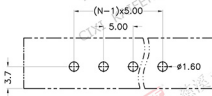
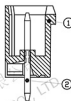
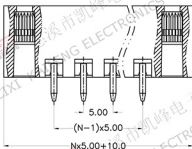
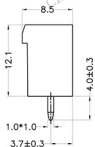
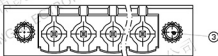

P.C.B.LAYOUT

- Material
 - ①Housing : PA66, UL94V-0
 - ②Pin header : Copper alloy, Tin plated
 - ③Nut : M2.5,Copper alloy
- Electrical
 - UL IEC
 - Rated voltage : 300V 320V
 - Rated current : 15A 20A
 - Contact resistance : 20mΩ(Max)
 - Insulation resistance : 500MΩ/DC500V
 - Withstanding Voltage : AC2000V/1min
- Mechanical
 - Operating temperature: -40℃ ~ +105℃
 - Soldering temperature: 250℃ ±5/5sec
- RoHS compliance

HOW TO ORDER

KF2EDGVM-X-5.0-XXP-1 X-XXXXX

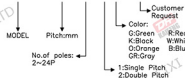

Pitch range		Nominal dimension range				PROJECTION	
>0	>6	>10	>0	>30	>60	>100	0.1/10
6	10	24	30	60	100	150	<
±0.15 (±0.20)		±0.30	±0.30	±0.50	±0.70	±1.00	±2

UNIT	TITLE
mm	KF2EDGVM-X-5.0-XXP-1X
SHEET SIZE	SERIES
A4	KF2EDGVM-X

DRAWING TYPE	CUSTOMER DRAWING
SCALE	1:1 SHEET 1 OF 1
DRAWING NO.	W10001612

DF 慈溪市凯峰电子有限公司
CIXI KAIFENG ELECTRONICS CO.,LTD

REV.	DESCRIPTION	DATE	DRAFTER	APPROVER
A1	DWG.REL	2020.5.20	ZHANG	JIN

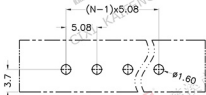
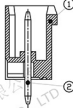
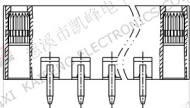
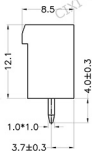
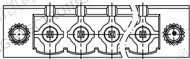

P.C.B.LAYOUT

- Material
 - ⊙Housing : PA66, UL94V-0
 - ⊙Pin header : Copper alloy, Tin plated
 - ⊙Nut : M2.5,Copper alloy
- Electrical
 - UL IEC
 - Rated voltage : 300V 320V
 - Rated current : 15A 20A
 - Contact resistance : 20mΩ(Max)
 - Insulation resistance : 500MΩ/DC500V
 - Withstanding Voltage : AC2000V/1min
- Mechanical
 - Operating temperature: -40℃~+105℃
 - Soldering temperature: 250℃±5/5sec
- RoHS compliance

HOW TO ORDER

KF2EDGVM-X-5.08-XXP-1 X-XXXXX

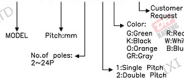

Pitch range	Nominal dimension range	PROJECTION	TITLE
>0	>60	0.1/10	KF2EDGVM-X-5.08-XXP-1X
>6	>100	<	SHEET SIZE A4
8	10	24	SERIES KF2EDGVM-X
10	24	30	
15	30	60	
20	30	100	
30	30	150	
40	±0.30	±0.50	
50	±0.70	±1.00	
60	±1.30	±2	
DRAWING TYPE CUSTOMER DRAWING		慈溪市凯峰电子有限公司 CIXI KAIFENG ELECTRONICS CO.,LTD	
SCALE 1:1	SHEET 1 OF 1		
DRAWING NO. W10001632			

REV.	DESCRIPTION	DATE	DRAFTER	APPROVER
A1	DWG.REL	2020.6.02	ZHANG	JIN

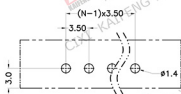
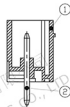
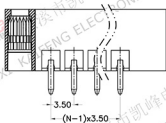
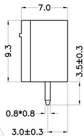
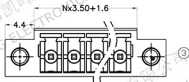

P.C.B.LAYOUT

- Material
 - ØHousing : PA66, UL94V-0
 - ØPin header : Copper alloy, Tin plated
 - ØNut : M2.5,Copper alloy
- Electrical
 - UL IEC
 - Rated voltage : 300V 250V
 - Rated current : 8A 7A
 - Contact resistance : 20mΩ(Max)
 - Insulation resistance: 500MΩ/DC500V
 - Withstanding Voltage : AC1500V/1min
- Mechanical
 - Operating temperature: -40℃~+105℃
 - Soldering temperature: 250℃±5/5sec
- RoHS compliance

HOW TO ORDER

KF2FDGVM-X-3.5-XXP-1 X-XXXXX



Pitch range	Nominal dimension range	PROJECTION	TITLE
>0	>0	UNIT	mm
>6	>60	SHEET SIZE	A4
>10	>100	SERIES	KF2EDGVM-Y
>15	>150	慈溪市凯峰电子有限公司 CIXI KAIFENG ELECTRONICS CO.,LTD	
±0.15	±0.30	SCALE	1:1
±0.30	±0.50	SHEET	1 OF 1
±0.50	±1.00	DRAWING NO.	W10000712

REV.	DESCRIPTION	DATE	DRAFTER	APPROVER
A1	DWG.REL	2020.6.02	ZHANG	JIN

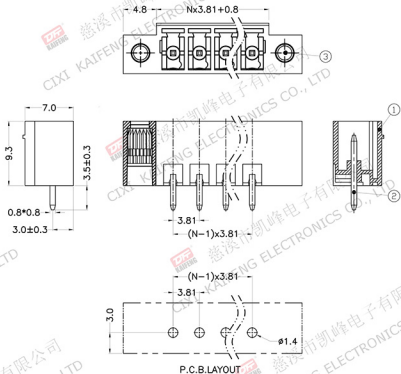

- Material
 ØHousing : PA66, UL94V-0
 ØPin header : Copper alloy, Tin plated
 ØNut : M2.5,Copper alloy
- Electrical
 Rated voltage : 300V IEC 250V
 Rated current : 8A 7A
 Contact resistance : 20mΩ(Max)
 Insulation resistance : 500MΩ/DC500V
 Withstanding Voltage : AC1500V/1min
- Mechanical
 Operating temperature: -40℃~+105℃
 Soldering temperature: 250℃±5/5sec
- RoHS compliance

HOW TO ORDER

KF2EDGVM-Y-3.81-XXP-1 X-XXXX



Pitch range		Nominal dimension range		PROJECTION	TITLE						
>0	>6	>10	>0	>30	>60	>100	>150	6.1/10	UNIT	mm	KF2EDGVM-Y-3.81-XXP-1X
6	10	24	30	60	100	150	≥150	≤	SHEET SIZE	A4	SERIES KF2EDGVM-Y
±0.15	±0.20	±0.30	±0.30	±0.50	±0.70	±1.00	±1.30	±2	SCALE		
DRAWING TYPE		CUSTOMER DRAWING									
SCALE		1:1		SHEET		1 OF 1		慈溪市凯峰电子有限公司 CIXI KAIFENG ELECTRONICS CO.,LTD			
DRAWING NO.		W10000742									

REV.	DESCRIPTION	DATE	DRAFTER	APPROVER
A1	DWG.REL	2020.6.02	ZHANG	JIN

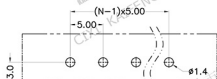
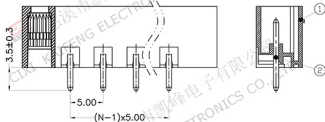
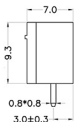

P.C.B.LAYOUT

- Material
 - ØHousing : PA66, UL94V-0
 - ØPin header : Copper alloy, Tin plated
 - ØNut : M2.5,Copper alloy
- Electrical
 - UL IEC
 - Rated voltage : 300V 320V
 - Rated current : 8A 7A
 - Contact resistance : 20mΩ(Max)
 - Insulation resistance: 500MΩ/DC500V
 - Withstanding Voltage : AC2000V/1min
- Mechanical
 - Operating temperature: -40℃~+105℃
 - Soldering temperature: 250℃±5/5sec
- RoHS compliance

HOW TO ORDER

KF2EDGVM-Y-5.0-XXP-1 X-XXXXX

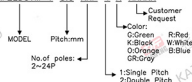

Pitch range	Nominal dimension range	PROJECTION	UNIT	TITLE
>0	>0	0.1/10	mm	KF2EDGVM-Y-5.0-XXP-1X
≤6	≤60	≤	A4	SHEET SIZE
≤15	≤150	±2		SERIES KF2EDGVM-Y
DRAWING TYPE		CUSTOMER DRAWING		
SCALE		1:1 SHEET 1 OF 1		
DRAWING NO.		W10000772		

DF

慈溪市凯峰电子有限公司
CIXI KAIFENG ELECTRONICS CO.,LTD

REV.	DESCRIPTION	DATE	DRAFTER	APPROVER
A1	DWG.REL	2020.6.02	ZHANG	JIN

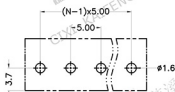
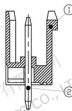
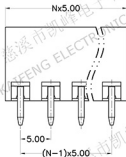
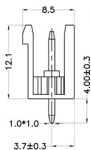
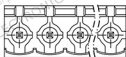

P.C.B.LAYOUT

- Material
 - ØHousing : PA66, UL94V-0
 - ØPin header : Copper alloy, Tin plated
- Electrical
 - UL IEC
 - Rated voltage : 300V 320V
 - Rated current : 15A 20A
 - Contact resistance : 20mΩ(Max)
 - Insulation resistance: 500MΩ/DC500V
 - Withstanding Voltage : AC2000V/1min
- Mechanical
 - Operating temperature: -40℃~+105℃
 - Soldering temperature: 250℃±5/5sec
- RoHS compliance

HOW TO ORDER

KF2EDGV-X-5.0-XXP-1 X-XXXXX



Pitch range	Nominal dimension range	PROJECTION
>0	>6	0.1/10
>10	>30	>60
>24	>60	>100
>30	>60	>150
±0.15(±0.20)	±0.30(±0.50)	±1.00(±1.30)
±0.30(±0.50)	±0.70(±1.00)	±1.30(±2.0)

UNIT	TITLE
mm	KF2EDGV-X-5.0-XXP-1X
SHEET SIZE	SERIES
A4	KF2EDGV-X

DRAWING TYPE	CUSTOMER DRAWING
SCALE	1:1 SHEET 1 OF 1
DRAWING NO.	W10000652

DF 慈溪市凯峰电子有限公司
CIXI KAIFENG ELECTRONICS CO.,LTD

REV.	DESCRIPTION	DATE	DRAFTER	APPROVER
A1	DWG.REL	2020.6.02	ZHANG	JIN

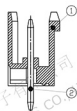
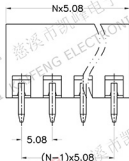
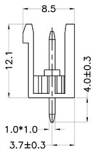
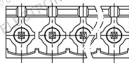

P.C.B.LAYOUT

- Material
 - ①Housing : PA66, UL94V-0
 - ②Pin header : Copper alloy, Tin plated
- Electrical
 - UL IEC
 - Rated voltage : 300V 320V
 - Rated current : 15A 20A
 - Contact resistance : 20mΩ(Max)
 - Insulation resistance: 500MΩ/DC500V
 - Withstanding Voltage : AC2000V/1min
- Mechanical
 - Operating temperature: -40℃~+105℃
 - Soldering temperature: 250℃±5/5sec
- RoHS compliance

HOW TO ORDER

KF2EDGV-X-5.08-XXP-1 X-XXXX

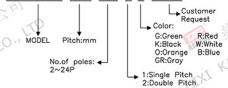

Pitch range		Nominal dimension range				PROJECTION	TITLE
>0	>6	>10	>0	>30	>60	>100	6.1/10
6	10	24	30	60	100	150	<
±0.15	±0.20	±0.30	±0.30	±0.50	±0.70	±1.00	±1.30
							±2
DRAWING TYPE		CUSTOMER DRAWING					
SCALE		1:1 SHEET 1 OF 1					
DRAWING NO.		W10000602					
UNIT							mm
SHEET SIZE							A4
SERIES							KF2EDGV-X
TITLE							KF2EDGV-X-5.08-XXP-1X

DF 慈溪市凯峰电子有限公司
CIXI KAIFENG ELECTRONICS CO., LTD

REV.	DESCRIPTION	DATE	DRAFTER	APPROVER
A1	DWG.REL	2020.5.18	ZHANG	JIN

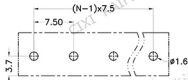
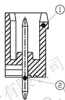
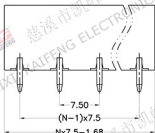
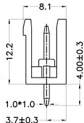
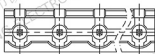

P.C.B.LAYOUT

- Material
 - ⊙Housing : PA66, UL94V-0
 - ⊙Pin header :Copper alloy, Tin plated
- Electrical
 - UL IEC
 - Rated voltage : 300V 400V
 - Rated current : 15A 20A
 - Contact resistance : 20mΩ(Max)
 - Insulation resistance: 500MΩ/DC500V
 - Withstanding Voltage : AC2500V/1min
- Mechanical
 - Operating temperature: -40℃~+105℃
 - Soldering temperature: 250℃±5/5sec
- RoHS compliance

HOW TO ORDER

KF2EDGV-X-7.5-XXP-1 X-XXXX



Pitch range	Nominal dimension range	PROJECTION	TITLE
>0	>60	0.1/10	KF2EDGV-X-7.5-XXP-1X
6	10 24 30 60 100 150	<	SHEET SIZE A4 SERIES KF2EDGV-X
±0.15(±0.20)	±0.30(±0.50)	±1.00(±1.30)	±2
DRAWING TYPE CUSTOMER DRAWING		慈溪市凯峰电子有限公司 CIXI KAIFENG ELECTRONICS CO.,LTD	
SCALE 1:1 SHEET 1 OF 1			
DRAWING NO. W10000082			

REV.	DESCRIPTION	DATE	DRAFTER	APPROVER
A1	DWG.REL	2020.5.20	ZHANG	JIN

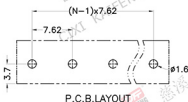
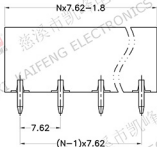
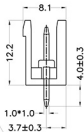
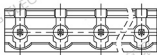

P.C.B.LAYOUT

- Material
 ○Housing : PA66, UL94V-0
 ○Pin header : Copper alloy, Tin plated
- Electrical IEC
 Rated voltage : 300V 400V
 Rated current : 15A 20A
 Contact resistance : 20mΩ(Max)
 Insulation resistance : 500MΩ/DC500V
 Withstanding Voltage : AC2500V/1min
- Mechanical
 Operating temperature : -40°C ~ +105°C
 Soldering temperature : 250°C ± 5/5sec
- RoHS compliance

HOW TO ORDER

KF2EDGV-X-7.62-XXP-1 X-XXXXX

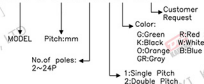

Pitch range		Nominal dimension range				PROJECTION	TITLE
>0	>6	>10	>0	>30	>60	>100	>150
6	10	24	30	60	100	150	±150
±0.15	±0.20	±0.30	±0.30	±0.50	±0.70	±1.00	±1.30
							±2

UNIT	mm
SHEET SIZE	A4

SERIES	TITLE
KF2EDGV-X	KF2EDGV-X-7.62-XXP-1X

SCALE	CUSTOMER DRAWING
1:1	SHEET 1 OF 1
DRAWING NO.	W10000162

DF 慈溪市凯峰电子有限公司
CIXI KAIFENG ELECTRONICS CO.,LTD

REV.	DESCRIPTION	DATE	DRAFTER	APPROVER
A1	DWG.REL	2020.6.08	ZHANG	JIN

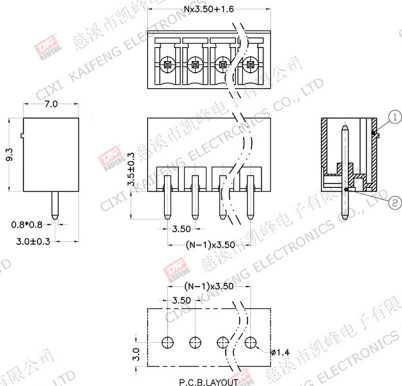

- Material
 - ①Housing : PA66, UL94V-0
 - ②Pin header : Copper alloy, Tin plated
- Electrical
 - UL IEC
 - Rated voltage : 300V 250V
 - Rated current : 8A 7A
 - Contact resistance : 20mΩ(Max)
 - Insulation resistance : 500MΩ/DC500V
 - Withstanding Voltage : AC1500V/1min
- Mechanical
 - Operating temperature : -40℃ ~ +105℃
 - Soldering temperature : 250℃ ± 5/5sec
- RoHS compliance

HOW TO ORDER

KF2EDGV-Y-3.5-XXP-1 X-XXXXX



Pitch range	Nominal dimension range	PROJECTION	UNIT	TITLE					
>0	>6	>10	>30	>60	>100	>150	6.1/10	mm	KF2EDGV-Y-3.5-XXP-1X
6	10	24	30	60	100	150	<	SHEET SIZE	A4
±0.15		±0.20	±0.30	±0.30	±0.50	±0.70	±1.00	±1.30	±2
DRAWING TYPE		CUSTOMER DRAWING							
SCALE		1:1		SHEET		1 OF 1			
DRAWING NO.		W10000842							



慈溪市凯峰电子有限公司
CIXI KAIFENG ELECTRONICS CO., LTD

REV.	DESCRIPTION	DATE	DRAFTER	APPROVER
A1	DWG.REL	2020.6.08	ZHANG	JIN

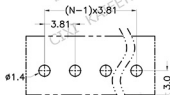
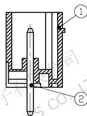
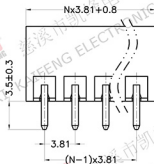
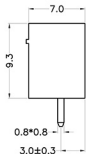

P.C.B.LAYOUT

- Material
 ①Housing : PA66, UL94V-0
 ②Pin header : Copper alloy, Tin plated
- Electrical
 UL IEC
 Rated voltage : 300V 250V
 Rated current : 8A 7A
 Contact resistance : 20mΩ(Max)
 Insulation resistance : 500MΩ/DC500V
 Withstanding Voltage : AC1500V/1min
- Mechanical
 Operating temperature : -40℃ ~ +105℃
 Soldering temperature : 250℃ ±5/5sec
- RoHS compliance

HOW TO ORDER

KF2EDGV-Y-3.81-XXP-1 X-XXXXX



Pitch range	Nominal dimension range	PROJECTION	TITLE
>0	>10	0.1/10	KF2EDGV-Y-3.81-XXP-1X
~6	~30	≤	SHEET SIZE A4
~10	~60		SERIES KF2EDGV-Y
~15	~100		
~20	~150		
~30	~200		
~40	~300		
~50	~400		
~60	~500		
~80	~800		
~100	~1000		
~150	~1500		
~200	~2000		
~300	~3000		
~400	~4000		
~500	~5000		
~600	~6000		
~800	~8000		
~1000	~10000		
~1500	~15000		
~2000	~20000		
~3000	~30000		
~4000	~40000		
~5000	~50000		
~6000	~60000		
~8000	~80000		
~10000	~100000		

DRAWING TYPE	CUSTOMER DRAWING
SCALE	1:1 SHEET 1 OF 1
DRAWING NO.	W10000862



慈溪市凯峰电子有限公司
CIXI KAIFENG ELECTRONICS CO.,LTD

REV.	DESCRIPTION	DATE	DRAFTER	APPROVER
A1	DWG.REL	2020.6.08	ZHANG	JIN

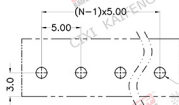
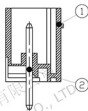
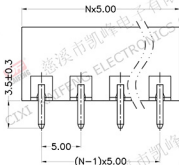
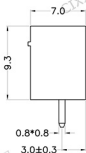
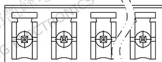

P.C.B.LAYOUT

- Material
 ○Housing : PA66, UL94V-0
 ○Pin header : Copper alloy, Tin plated
- Electrical
 UL IEC
 Rated voltage 300V 320V
 Rated current : 8A 7A
 Contact resistance : 20mΩ(Max)
 Insulation resistance: 500MΩ/DC500V
 Withstanding Voltage : AC2000V/1min
- Mechanical
 Operating temperature: -40℃~+105℃
 Soldering temperature: 250℃±5/5sec
- RoHS compliance

HOW TO ORDER

KF2EDGV-Y-5.0-XXP-1 X-XXXX



Pitch range	Nominal dimension range	PROJECTION	TITLE
>0	>0	6.1/10	KF2EDGV-Y-5.0-XXP-1X
6	60	<	SHEET SIZE A4
15	150		SERIES KF2EDGV-Y
DRAWING TYPE CUSTOMER DRAWING		慈溪市凯峰电子有限公司 CIXI KAIFENG ELECTRONICS CO.,LTD	
SCALE 1:1	SHEET 1 OF 1		
DRAWING NO. W10000892			

REV.	DESCRIPTION	DATE	DRAWER	APPROVER
A1	DWG.REL	2020.6.08	ZHANG	JIN

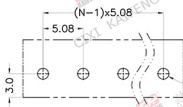
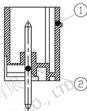
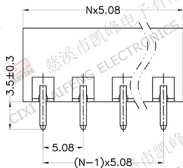
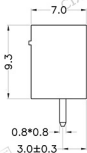
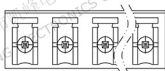

P.C.B.LAYOUT

- Material
 ØHousing : PA66, UL94V-0
 ØPin header : Copper alloy, Tin plated
- Electrical
 UL IEC
 Rated voltage : 300V 320V
 Rated current : 8A 7A
 Contact resistance : 20mΩ(Max)
 Insulation resistance : 500MΩ/DC500V
 Withstanding Voltage : AC2000V/1min
- Mechanical
 Operating temperature: -40℃~+105℃
 Soldering temperature: 250℃±5/5sec
- RoHS compliance

HOW TO ORDER

KF2EDGV-Y-5.08-XXP-1 X-XXXX



Pitch range	Nominal dimension range	PROJECTION	TITLE
≥0	≥0	0.1/10	KF2EDGV-Y-5.08-XXP-1X
8	80	≤	SHEET SIZE A4
±0.15	±0.30		SERIES KF2EDGV-Y
DRAWING TYPE CUSTOMER DRAWING		慈溪市凯峰电子有限公司 CIXI KAIFENG ELECTRONICS CO.,LTD	
SCALE 1:1	SHEET 1 OF 1		
DRAWING NO. W10000922			