

REV.	DESCRIPTION	DATE	DRAFTER	APPROVER
A1	DWG.REL	2020.05.22	DENG	JIN

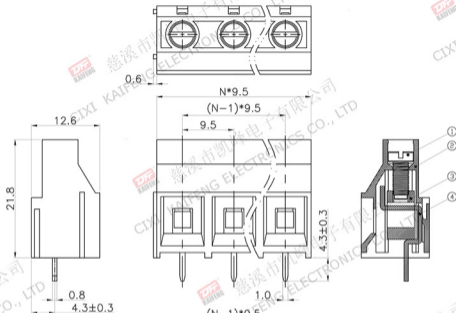

- Material
 - ØScrews : M3.0 steel, Zinc plated, *-* slot type
 - ØHousing : PA66, UL94V-0
 - ØClamp : Copper alloy, Ni plated
 - ØPin header : Copper alloy, Tin plated

- Electrical
 - UL IEC
 - Rated voltage : 300V 750V
 - Rated current : 30A 41A
 - Contact Resistance: 20mΩ
 - Insulation resistance: 500MΩ/1000V
 - Withstanding Voltage : AC3000V/1min
 - Wire range: 26-10AWG 6.0mm²

- Mechanical
 - Operating temperature: -40°C ~ +105°C
 - Soldering temperature: 250°C ± 5/5sec
 - Torque: 0.5N.m (4.43lb.in)
 - Strip length: 6-7mm

- RoHS compliance

HOW TO ORDER

KF950-9.5-XXP-1 X-XXXXX

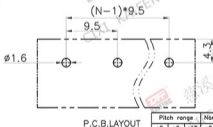
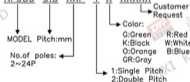

Pitch range	Nominal dimension range	PROJECTION	UNIT	TITLE
>0	>0	6.1/10	mm	KF950-9.5-XXP-1X
6	60	<	SHEET SIZE	A4
15	150		SERIES	KF950
DRAWING TYPE		CUSTOMER DRAWING		
SCALE		1:1 SHEET 1 OF 1		
DRAWING NO.		W15000822		

DF

慈溪市凯峰电子有限公司
CIXI KAIFENG ELECTRONICS CO., LTD

REV.	DESCRIPTION	DATE	DRAFTER	APPROVER
A1	DWG.REL	2020.05.23	DENG	JIN

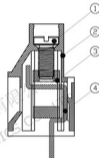
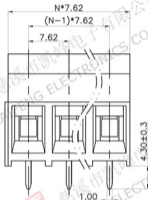

- Material
 - ØScrews : M3.0 steel, Zinc plated, -* slot type
 - ØHousing : PA66, UL94V-0
 - ØClamp : Copper alloy, Ni plated
 - ØPin header : Copper alloy, Tin plated

- Electrical
 - UL IEC
 - Rated voltage : 300V 750V
 - Rated current : 30A 41A
 - Contact Resistance: 20mΩ
 - Insulation resistance: 500MΩ/DC500V
 - Withstanding Voltage : AC3000V/1min
 - Wire range : 26-10AWG 6.0mm²

- Mechanical
 - Operating temperature: -40℃ ~ +105℃
 - Soldering temperature: 250℃ ±5/5sec
 - Torque : 0.5N.m (4.43Lb.in)
 - Strip length: 6-7mm

- RoHS compliance

HOW TO ORDER

KF950A1-9.5-XXP-1 X-XXXX



P.C.B. LAYOUT

Pitch range	Nominal dimension range	PROJECTION	UNIT	TITLE
>0	>0	6.1/10	mm	KF950A1-7.62-XXP-1X
>6	>30	<	SHEET SIZE	A4
>10	>60		SERIES	KF950A1
>24	>100			
>30	>150			
>30	>150			
±0.15	±0.20			
±0.30	±0.50			
±0.70	±1.00			
±1.30	±2			
DRAWING TYPE		CUSTOMER DRAWING		
SCALE		1:1 SHEET 1 OF 1		
DRAWING NO.		W15000842		



慈溪市凯峰电子有限公司
CIXI KAIFENG ELECTRONICS CO.,LTD

REV.	DESCRIPTION	DATE	DRAFTER	APPROVER
A1	DWG.REL	2020.05.22	DENG	JIN

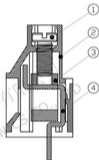
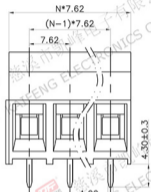
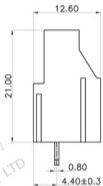
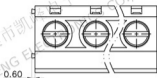

P.C.B.LAYOUT

- Material
 - ØScrews : M3.0 steel, Zinc plated, -* slot type
 - ØHousing : PA66, UL94V-0
 - ØClamp : Copper alloy, Ni plated
 - ØPin header : Copper alloy, Tin plated

- Electrical
 - UL IEC
 - Rated voltage : 300V 750V
 - Rated current : 30A 41A
 - Contact Resistance: 20mΩ
 - Insulation resistance: 500MΩ/DC500V
 - Withstanding Voltage : AC3000V/1min
 - Wire range : 26-10AWG 6.0mm²

- Mechanical
 - Operating temperature: -40°C ~ +105°C
 - Soldering temperature: 250°C ±5/5sec
 - Torque : 0.5N.m (4.43Lb.in)
 - Strip length: 6-7mm

- RoHS compliance

HOW TO ORDER

KF950A-9.5-XXP-1 X-XXXXX



Pitch range	Nominal dimension range	PROJECTION	TITLE
>0	>0	UNIT	mm
>6	>60	SHEET SIZE	A4
>10	>100	SERIES	KF950A
>24	>240	KF950A-7.62-XXP-1X	
>30	>300	慈溪市凯峰电子有限公司	
>30	>300	CIXI KAIFENG ELECTRONICS CO.,LTD	
>30	>300	DRAWING NO. W15000832	

DF

慈溪市凯峰电子有限公司
CIXI KAIFENG ELECTRONICS CO.,LTD