

## Junction Box, 4 Ports, M12 Termination, Molded Cable

- Connector series: Junction Box
- Termination: M12
- Locking type: Fix screw
- Coding type: A-coding
- Part No.: JB4M12F\*\*L-XX (with LED)  
JB4M12F\*\*-XX (without LED)

\*\* refers to pins number  
X refers to cable length

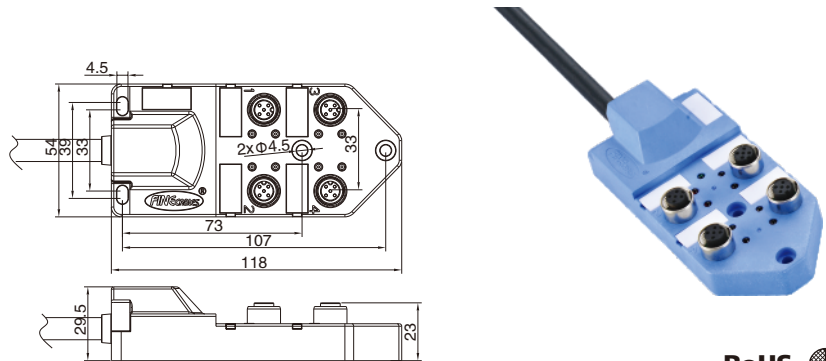

RoHS

### General information

Ambient temperature:	-40°C ~ +80°C(fixed installation) -25°C ~ +80°C(flexible installation)
Connector insert:	TPU/PA
Connector contacts:	Brass with gold plated
Material of body:	PBT
Coupling nut/screw:	Brass with nickel plated
Body color:	Blue
Seal:	FKM

Contact resistance :	≤ 3mΩ
Rated voltage with/without LED:	10~30V/120V
Rated current:	1A per signal,3A total
LED color:	Optional
IP rating:	IP 67 in locked condition

### Electrical data & Mechanical data

Contacts	Circuit diagram	Cable Specification
<p>04Pins</p> <p>Blind hole Pin assignment M12(Female)</p>		<p>Cable: 3C*0.75mm<sup>2</sup>(18AWG)+ 4C*0.34mm<sup>2</sup>(22AWG) PUR/PVC jacket by customized</p>
<p>05Pins</p> <p>Pin assignment M12(Female)</p>		<p>Cable: 3C*0.75mm<sup>2</sup>(18AWG)+ 8C*0.34mm<sup>2</sup>(22AWG) PUR/PVC jacket by customized</p>