

M12 Female Panel, PCB, Front fastened, Y4-coding, Shielded

- Connector series: M12
- Gender: Female
- Coding: Y4
- Locking type: Fix screw
- Mounting type: Straight
- Part No.: MB12FBSY408ST-2

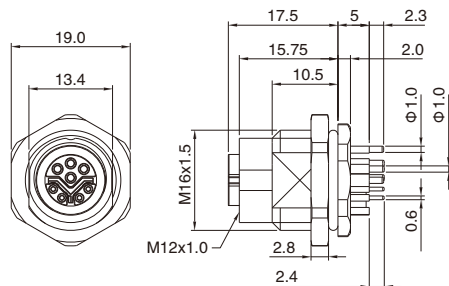

General information

Standard:	IEC 61076-2-113
Ambient temperature:	-40°C ~ +80°C(fixed installation) -20°C ~ +80°C(flexible installation)
Connector insert:	TPU+GF
Connector contacts:	Brass with gold plated
Connector overmold:	TPU
Connector nut/screw:	Brass with nickel plated
Seal / O-ring:	FKM

Insulation resistance:	≥ 100MΩ
Contact resistance :	≤ 10mΩ
Shielding:	Available
IP rating:	IP67 in locked condition
Mating endurance:	>500 cycles

Electrical data & Mechanical data

Contacts	Contacts termination	Rated current	Voltage		Part No.
			A/C	D/C	
08 pins 	PCB	6A	50V	50V	MB12FBSY408ST-2

Panel Cut-out Dimensions

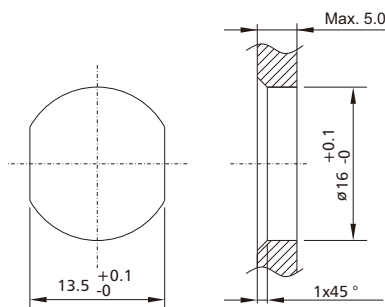

Remarks

- Please refer to Page 578 for the Conversion between American Wire Gauge AWG and Wire Cross-section mm².
- Please refer to Page 96 for products' part number encoding rule.