



Microswitch - SERIES MP300



Series MP300

MP300

A versatile miniature IP67 microswitch with a temperature range up to 170°C and stainless steel levers. Ideal for a wide range of applications, including those in the most demanding industrial environments. The MP300 Series features unparalleled flexibility in terms of levers and telescopic plungers. Small differential travel, large choice of cable and wire connections makes this switch a perfect solution for industrial OEM customers.



Description

MP310

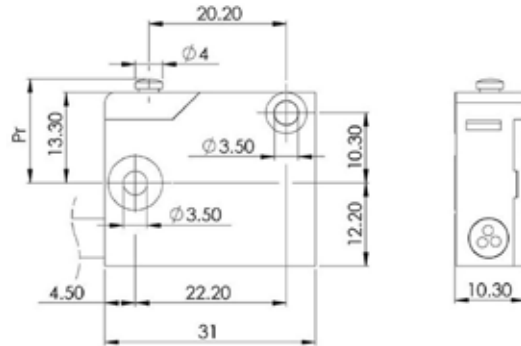

MP320

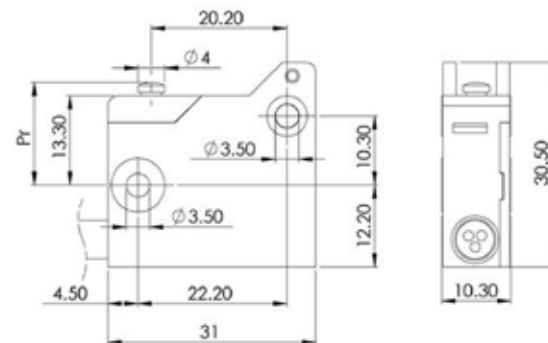

Series MP300 offers the choice of two housings:

MP310: reduced height without the possibility to mount additional actuators

MP320: mounting extension for actuators



Description

MP310 / MP320

Approval	EN 61058-1	250VAC/6A	50'000 cycles
	EN 61058-1	400VAC/6A	50'000 cycles*
	UL 61058-1	250VAC/6A	50'000 cycles
	UL 61058-1	400VAC/6A	50'000 cycles*
	CSA C22.2	250VAC/6A	6'000 cycles*
	ATEX 113d/Ex t IIIB 84°C Dc	250VAC/6A*	
*Optional	Resistive load		

Housing	Plastic reinforced with glass fiber (PBT or PPS for high temperature or ATEX)
Pin Button	PPS
Membrane	Fluorosilicone - other optional materials available
Switching Circuit	Change over - snap action with blade spring in copper/beryllium
Contact	Silver - optional gold
Connection	Cable Various cable exit option : Standard - Opposite - Underside PVC -20°C to +105°C PVCU -20°C to +105°C (Approval UL) PUR -40°C to +90°C SI -40°C to +130°C PTFE -40°C to +170°C Other material optional
Actuator	Stainless steel
Degree of Protection	Housing IP67 Connection IP67
Class of Protection	II
Micro-switching	μ
Distance between Contacts	0.80 mm
Dimensions	DIN 41 635, form E 31 x 24 x 10.3 mm
Actuation Force	1.3 to 4.0 N, depending on the lever
Differential Travel	0.05 mm - Optional 0.02 mm
Temperature Range	EN 61058-1 -40°C to +170°C UL 61058-1 -40°C to +130°C CSA 22.2 T amb. ATEX -15°C to +80°C Cable selection may reduce temperature range
Mechanical Life	50 x 10 ⁶ cycles

Actuator

Type 0: Basic switch - Pin Button

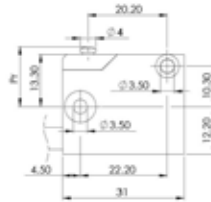

Actuating Force F_a max. (N)	3.5
Release Force F_r min. (N)	1.0
Free Position P_r (mm)	15.3 ± 0.3
Operating Position P_a (mm)	14.7 ± 0.2
Over-Travel s_r min. (mm)	0.20
Differential Travel s_d max. (mm)	0.05

Type 1MS27: Telescopic

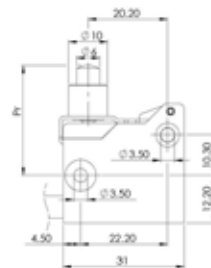
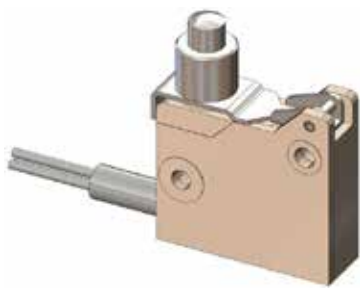

Actuating Force F_a max. (N)	3.5
Release Force F_r min. (N)	1.0
Free Position P_r (mm)	27.7 ± 0.6
Operating Position P_a (mm)	27.2 ± 0.3
Over-Travel s_r min. (mm)	2.0
Differential Travel s_d max. (mm)	0.1

Type 1M: Telescopic with Thread

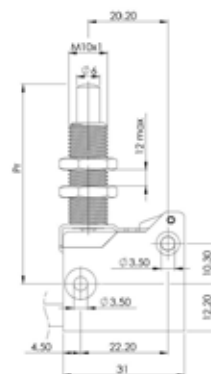
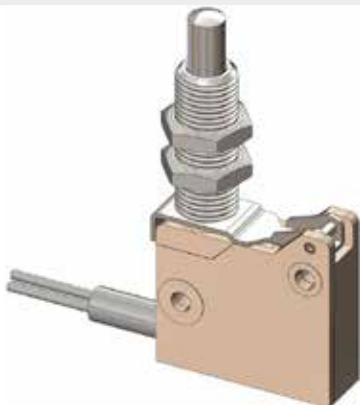

Actuating Force F_a max. (N)	3.5
Release Force F_r min. (N)	1.0
Free Position P_r (mm)	50.3 ± 0.6
Operating Position P_a (mm)	49.7 ± 0.3
Over-Travel s_r min. (mm)	5.0
Differential Travel s_d max. (mm)	0.1

Type 1ML: Telescopic with Stainless Steel Roller

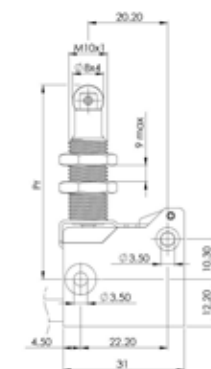
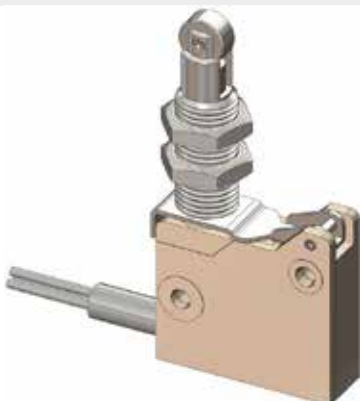

Actuating Force F_a max. (N)	3.5
Release Force F_r min. (N)	1.0
Free Position P_r (mm)	49.8 ± 0.6
Operating Position P_a (mm)	48.3 ± 0.3
Over-Travel s_r min. (mm)	5.0
Differential Travel s_d max. (mm)	0.1

Optional: transvers roller

Series MP300

Actuator

Type 3MA: Simple Lever - Indirect Action -

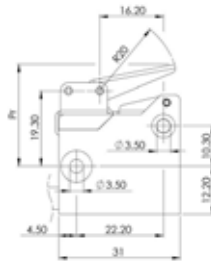
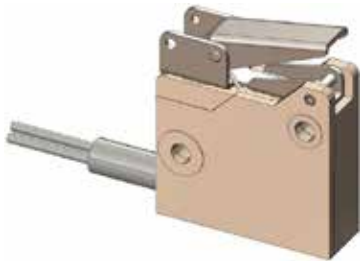

Actuating Force F_a max. (N)	2.5
Release Force F_r min. (N)	1.0
Free Position P_r (mm)	26.0 ± 1.0
Operating Position P_a (mm)	24.2 ± 0.6
Over-Travel s_r min. (mm)	2.5
Differential Travel s_d max. (mm)	0.8

Optional: lever mounted on opposite side

Type 5MAL: Simple Lever with Roller - Indirect Action -

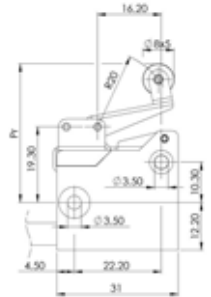
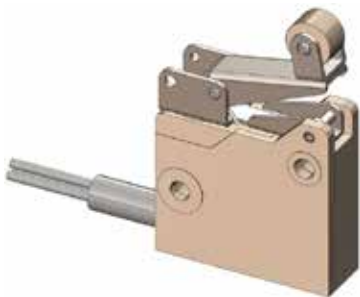

Actuating Force F_a max. (N)	3.0
Release Force F_r min. (N)	1.0
Free Position P_r (mm)	35.6 ± 1.0
Operating Position P_a (mm)	34.0 ± 0.6
Over-Travel s_r min. (mm)	2.5
Differential Travel s_d max. (mm)	0.8

Optional: lever mounted on opposite side, stainless steel roller (5MALA), transvers roller

Type 6MAL: Simple Lever with Bending Roller - Indirect Action -

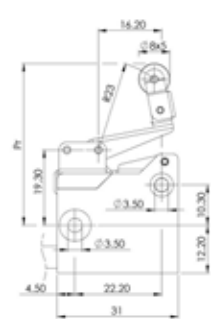
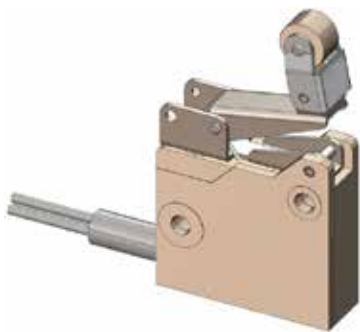

Actuating Force F_a max. (N)	3.0
Release Force F_r min. (N)	1.0
Free Position P_r (mm)	41.5 ± 1.0
Operating Position P_a (mm)	39.8 ± 0.6
Over-Travel s_r min. (mm)	2.5
Differential Travel s_d max. (mm)	0.8

Optional: lever mounted on opposite side, stainless steel roller (6MALA), transvers roller

Type 7M26: Simple Lever - Direct Action -

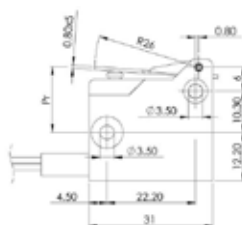
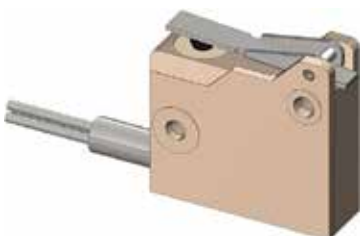

Actuating Force F_a max. (N)	3.5
Release Force F_r min. (N)	1.0
Free Position P_r (mm)	17.0 ± 1.0
Operating Position P_a (mm)	16.0 ± 0.3
Over-Travel s_r min. (mm)	0.2
Differential Travel s_d max. (mm)	0.1

Actuator

Type **7M**: Simple Lever - Direct Action -

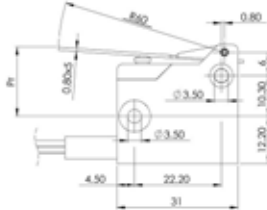
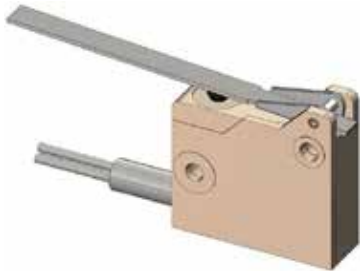

Actuating Force Fa max. (N)	1.3
Release Force Fr min. (N)	0.3
Free Position Pr (mm)	19.0 ± 1.0
Operating Position Pa (mm)	16.5 ± 0.8
Over-Travel sr min. (mm)	0.5
Differential Travel sd max. (mm)	0.8

Type **7MAF/127/50**: Simple Lever with Floater - Indirect Action -

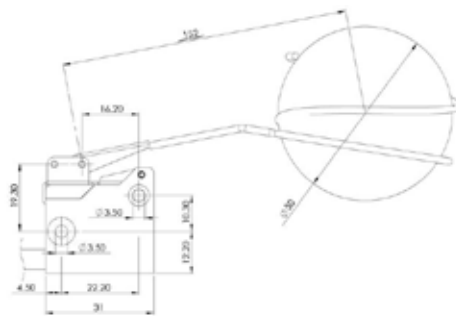

Actuating Force Fa max. (N)	-
Release Force Fr min. (N)	-
Free Position Pr (mm)	-
Operating Position Pa (mm)	-
Over-Travel sr min. (mm)	-
Differential Travel sd max. (mm)	2.00

Type **8ML25**: Simple Lever with Roller - Direct Action -

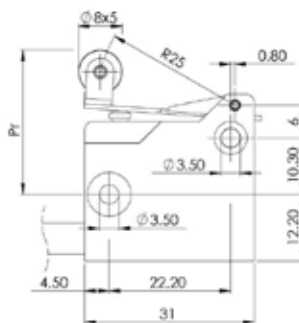
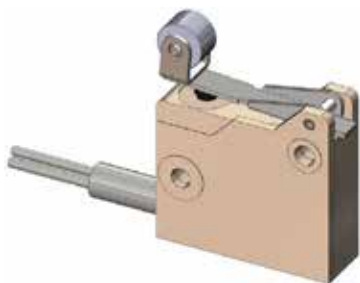

Actuating Force Fa max. (N)	3.5
Release Force Fr min. (N)	1.0
Free Position Pr (mm)	26.5 ± 1.0
Operating Position Pa (mm)	25.7 ± 0.3
Over-Travel sr min. (mm)	0.2
Differential Travel sd max. (mm)	0.1

Optional: stainless steel roller (8MLA25), transvers roller

Electrical Circuit

	Actuator Code	Circuit	Color
Direct Action	0 1MS27 1M 1ML 7M 7M26 8ML25		1 : Brown 2 : Black 4 : Blue
Indirect Action	3MA 5MAL 6MAL 7MAF/127/50		

Optional cable and wire exit

Standard exit

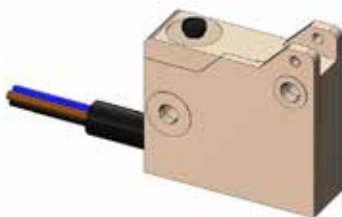

Opposite exit "S"

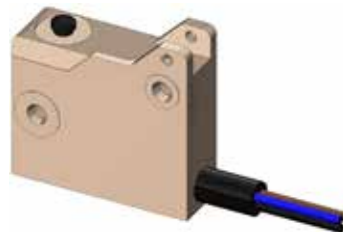

Underside exit "C"

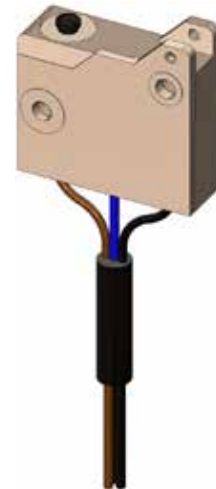



Ordering Information

		MP3	2	0	-	8ML25	/	3	75	/	100	PVC
Housing												
1:	Without Actuator											
2:	With Actuator											
Contact												
0:	Silver Contact											
1:	Gold Contact											
Actuator												
0:	Basic switch - Pin Button											
1MS27:	Telescopic											
1M:	Telescopic with Thread											
1ML:	Telescopic with Stainless Steel Roller											
3MA:	Simple Lever - Indirect Action											
5MAL:	Simple Lever with Roller - Indirect Action											
6MAL:	Simple Lever with Bending Roller - Indirect Action											
7M26:	Simple Lever - Direct Action											
7M:	Simple Lever - Direct Action											
7MAF/127/50:	Simple Lever with Floater - Indirect Action											
8ML25:	Simple Lever with Roller - Direct Action											
Number of conductors												
3:	Single Break											
Cross section												
75:	0.75 mm ² / 19AWG											
Cable length in centimeters (cm)												
Cable material												
PVC:	Polyvinyl Chloride -20°C to +105°C											
PVCU:	Polyvinyl Chloride -20°C to +105°C (Approval UL)											
PUR:	Polyurethane -40°C to +90°C											
SI:	Silicone -40°C to +130°C											
PTFE:	Polytetrafluoroethylene -40°C to +170°C (Actuator while stainless steel)											
Optional cable and wire exit												
	Standard exit - without code											
S:	Opposite exit											
C:	Underside exit											

Series MP300