



Microswitch - SERIES MP500



MP500

A subminiature microswitch of standardized small dimensions. The MP500 Series provides long mechanical service, small differential travel and wide temperature range up to 105°C.

Series MP500



Description

C000 : Solder Lugs

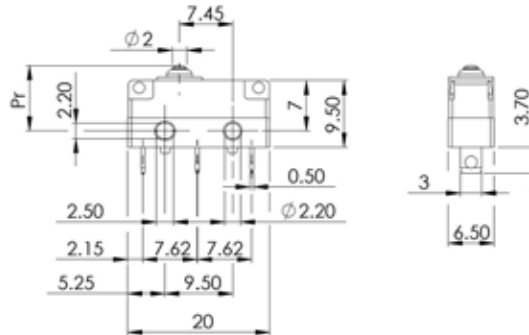

Use flexible wires.
Prevent moving wire to protect solder joint.

Prevent any overheating of the solder lugs as this could damage the microswitch. Limit temperature of solder iron to 340°C max. Apply iron for maximum 4 seconds and use solder wire without chlorine.

C001 : PCB Connection

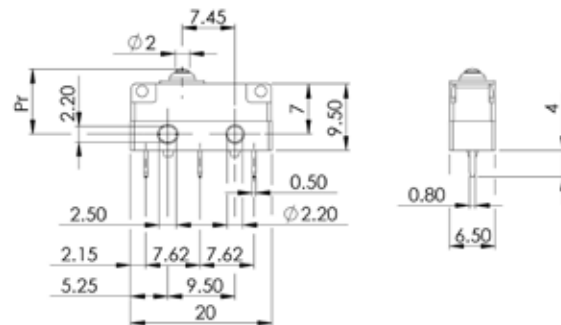

C100 : PVC potted cable

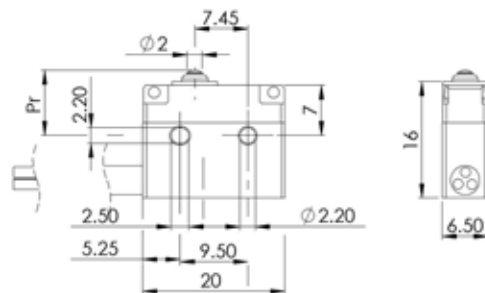
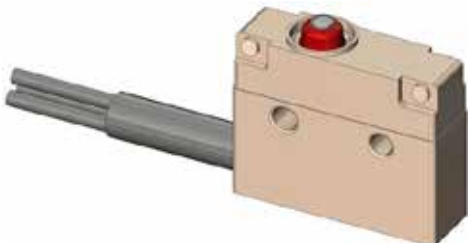



Description

MP500

Approval	EN 61058-1 250VAC/5A 25'000 cycles
	EN 61058-1 250VAC/2A 50'000 cycles
	UL 61058-1 250VAC/5A 25'000 cycles
	UL 61058-1 250VAC/2A 50'000 cycles
	Resistive load
Housing	Plastic reinforced with glass fiber (PA 6T/66)
Pin Button	PES
Membrane	Fluorosilicone
Switching Circuit	Change over - snap action with blade spring in copper/beryllium and stainless steel spring
Contact	Silver - optional gold
Connection	Cable PVC -20°C to +105°C
	PCB -40°C to +105°C
	Solder Lugs -40°C to +105°C
Actuator	Stainless steel
Degree of Protection	Housing IP67 / IP40
	Connection Cable IP67
	PCB IP00
	Solder Lugs IP00
Class of Protection	II
Micro-switching	μ
Distance between Contacts	0.40 mm
Dimensions	DIN 41 635, form B
	20 x 16 x 6.5 mm
Actuation Force	0.6 to 2.5 N, depending on the lever
Differential Travel	0.05 mm
Temperature Range	EN 61058-1 -40°C to +105°C
	UL 61058-1 -40°C to +105°C
	Cable selection may reduce temperature range
Mechanical Life	10 x 10 ⁶ cycles

Series MP500

Actuator

Type L00 : Basic switch - Pin Button

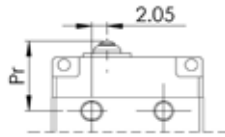

	MP500/550	MP520/570
Actuating Force Fa max. (N)	2.5	1.2
Release Force Fr min. (N)	0.5	0.2
Free Position Pr (mm)	9.3 ± 0.2	9.3 ± 0.2
Operating Position Pa (mm)	9.0 ± 0.2	9.0 ± 0.2
Over-Travel sr min. (mm)	0.6	0.6
Differential Travel sd max. (mm)	0.05	0.05

Type L70 : Simple Lever - position A

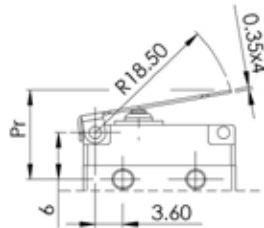
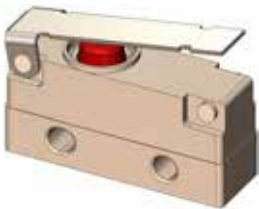

	MP500/550	MP520/570
Actuating Force Fa max. (N)	1.0	0.6
Release Force Fr min. (N)	0.15	0.1
Free Position Pr (mm)	12.0 ± 0.4	12.0 ± 0.4
Operating Position Pa (mm)	10.6 ± 0.4	10.6 ± 0.4
Over-Travel sr min. (mm)	1.2	1.2
Differential Travel sd max. (mm)	0.40	0.40

Type L71 : Simple Lever - position B

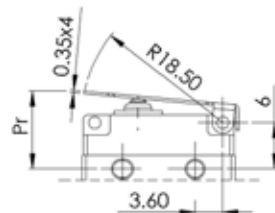
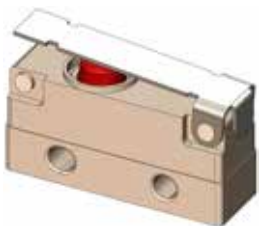

	MP500/550	MP520/570
Actuating Force Fa max. (N)	2.0	1.0
Release Force Fr min. (N)	0.3	0.2
Free Position Pr (mm)	10.3 ± 0.4	10.3 ± 0.4
Operating Position Pa (mm)	9.7 ± 0.4	9.7 ± 0.4
Over-Travel sr min. (mm)	0.6	0.6
Differential Travel sd max. (mm)	0.30	0.30

Type L80 : Simple Lever with Roller - position A

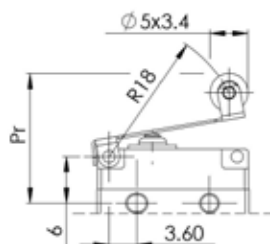

	MP500/550	MP520/570
Actuating Force Fa max. (N)	1.0	0.6
Release Force Fr min. (N)	0.15	0.1
Free Position Pr (mm)	17.2 ± 0.2	17.2 ± 0.4
Operating Position Pa (mm)	16.0 ± 0.2	16.0 ± 0.4
Over-Travel sr min. (mm)	1.2	1.2
Differential Travel sd max. (mm)	0.40	0.40

Actuator

Type **L81** : Simple Lever with Roller - position B

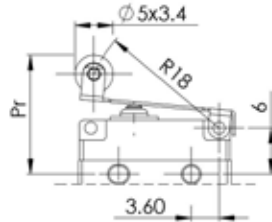

	MP500/550	MP520/570
Actuating Force Fa max. (N)	2.0	1.0
Release Force Fr min. (N)	0.3	0.2
Free Position Pr (mm)	15.7 ± 0.4	15.7 ± 0.4
Operating Position Pa (mm)	15.1 ± 0.4	15.1 ± 0.4
Over-Travel sr min. (mm)	0.6	0.6
Differential Travel sd max. (mm)	0.30	0.30

Type **L85** : Simple Lever with simulated Roller- position A

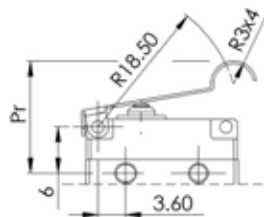
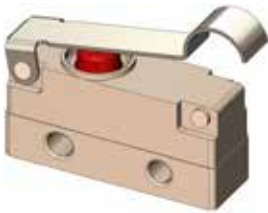

	MP500/550	MP520/570
Actuating Force Fa max. (N)	1.0	0.5
Release Force Fr min. (N)	0.15	0.1
Free Position Pr (mm)	14.7 ± 0.4	14.7 ± 0.4
Operating Position Pa (mm)	13.5 ± 0.4	13.5 ± 0.4
Over-Travel sr min. (mm)	1.2	1.2
Differential Travel sd max. (mm)	0.40	0.40

Type **L86** : Simple Lever with simulated Roller - position B

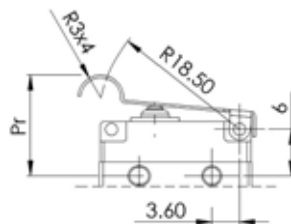
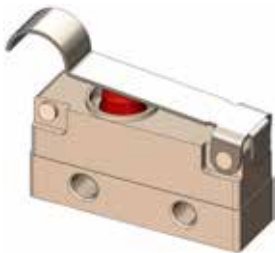

	MP500/550	MP520/570
Actuating Force Fa max. (N)	2.0	0.6
Release Force Fr min. (N)	0.3	0.2
Free Position Pr (mm)	13.2 ± 0.4	13.2 ± 0.4
Operating Position Pa (mm)	12.6 ± 0.4	12.6 ± 0.4
Over-Travel sr min. (mm)	0.6	0.6
Differential Travel sd max. (mm)	0.30	0.30

Version light force : MP520/MP570

For applications requiring a light actuating force, for example pressure switches, the Series MP500 offers a version with a modified spring force. All other parameters - dimension, electrical rating and IP protection remain unchanged.

Version IP40 MP550/MP570

For applications where IP protection is not an issue, the Series MP500 offers a version without the sealing membrane.

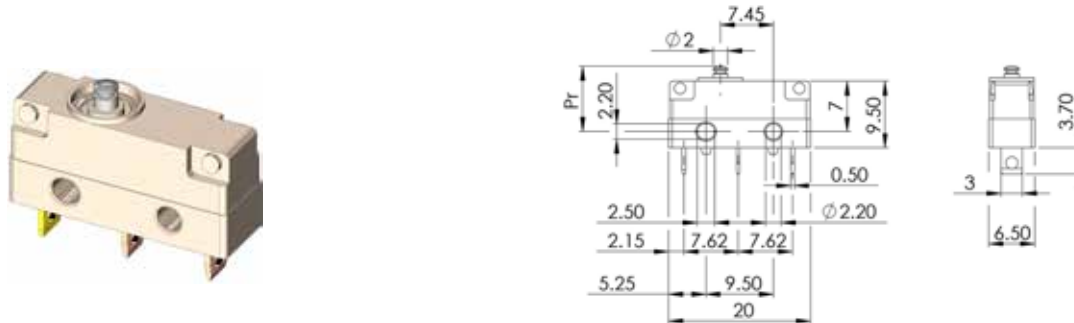

Electrical Circuit

	Connection Code	Circuit	Color - Code
Solder Lugs PCB	C000 C001		
PVC Cable	C10. / C20.		1 - Black 2 - Grey 4 - Blue



Ordering Information

MP5 0 0 - L70 - C100

Housing

- 0:** IP67
- 2:** IP67 Low force
- 5:** IP40
- 7:** IP40 Low force

Contact

- 0:** Silver Contact
- 1:** Gold Contact

Actuator

- 0:** Basic switch - Pin Button
- L70:** Simple Lever - position A
- L71:** Simple Lever - position B
- L80:** Simple Lever with Roller - position A
- L81:** Simple Lever with Roller - position B
- L85:** Simple Lever with simulated Roller - position A
- L86:** Simple Lever with simulated Roller - position B

Connection

- C000:** Solder Lugs 250VAC/5A
- C001:** PCB 250VAC/5A
- C100:** Cable PVC, 3x0.25mm², 250VAC 2A 0.5 (m)
- C101:** Cable PVC, 3x0.25mm², 250VAC 2A 1 (m)
- C102:** Cable PVC, 3x0.25mm², 250VAC 2A 2 (m)
- C200:** Cable PVC, 3x0.50mm², 250VAC 5A 0.5 (m)
- C201:** Cable PVC, 3x0.50mm², 250VAC 5A 1 (m)
- C202:** Cable PVC, 3x0.50mm², 250VAC 5A 2 (m)

Series MP500