

# SLIDE SWITCH NSS SERIES

## Slide Type (1P3T)

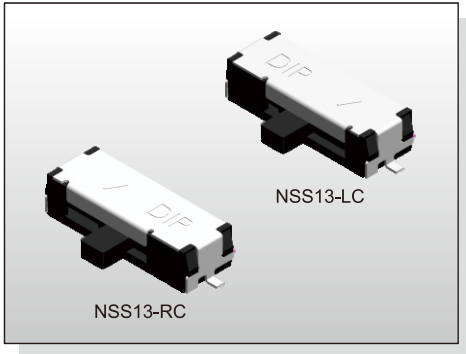

### FEATURES

- ※ 1P3T model
- ※ Single-side recoil type
- ※ Reflow solderable

### APPLICATION

- ※ Remote control
- ※ Consumer electronics
- ※ Instrumentations

### SPECIFICATION

Contact Rating	0.3A, 4V DC
Contact Resistance	100mΩ max.
Insulation Resistance	100MΩ min. 500V DC
Dielectric Strength	500V AC/1 minute
Operating Force	320±150gf (ON-TEST) 320±150gf (OFF-ON) 500+100/-200gf (ON-OFF)
Travel	2mm (ON-TEST) 4mm (OFF-ON) 4mm (ON-OFF)
Operating Life	10, 000 cycles
Operating Temp.	-20°C ~ +70°C
Storage Temp.	-40°C ~ +85°C

### HOW TO ORDER

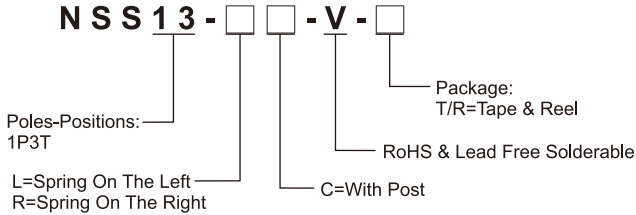

### CIRCUIT

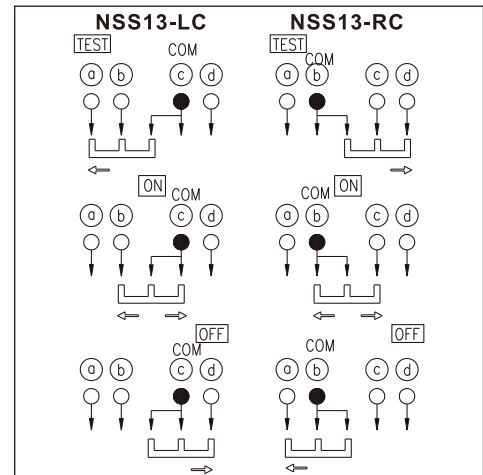

### PACKAGE

<Tape & Reel>  
800 pcs

### NSS13-LC

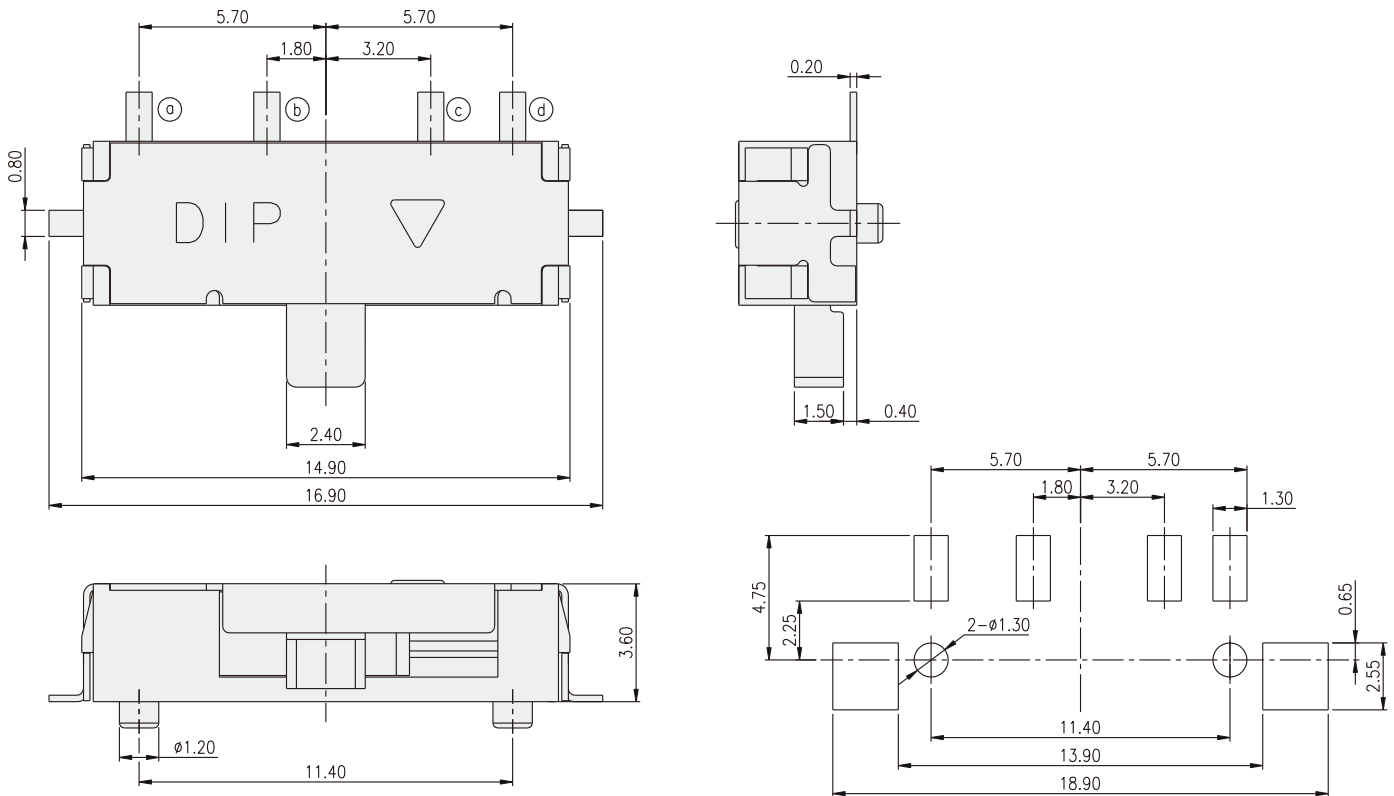

P.C.B. LAYOUT

**NSS13-RC**

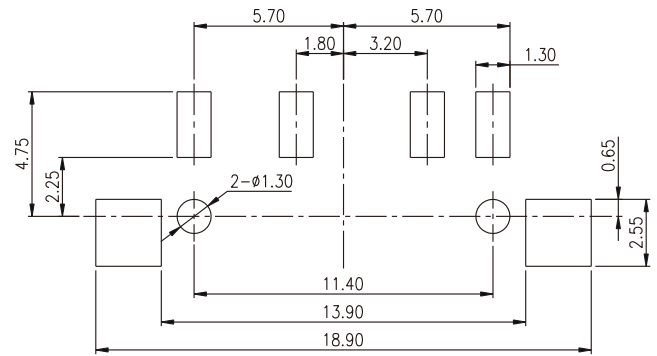
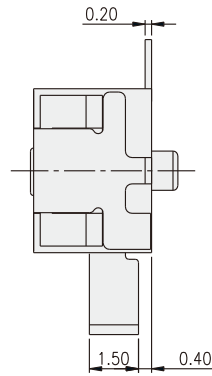
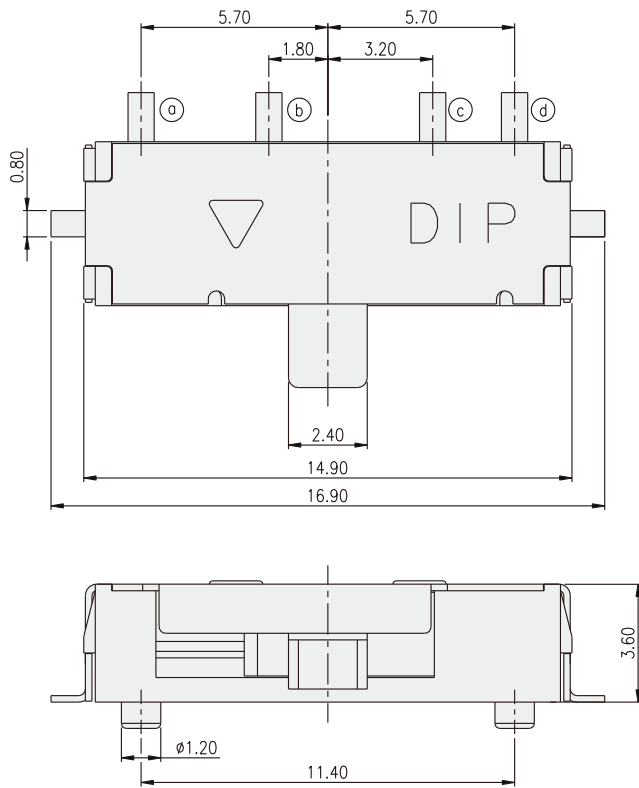

P.C.B. LAYOUT