

SPECIFICATIONS

Rating	:20A 125VAC (UL) 22A 250VAC (CQC ENEC)
Degree of protection	:IP55
Contact Resistance	:20mΩ(Max)
Insulation Resistance	:DC 500V 100MΩ (Min)
Dielectric Strength	:AC 1500V 1 minute
Operating Force	:500±200gf
Mechanical Life	:50,000cycles
Load Life	:10,000cycles
Operating Temperature	:-40°C~85°C
Safety Approval	:



LR-220-C5N-BB

LR-210-C5N-BG

特点

- 最高达30A大电流
- 大防尘、防爆特性
- 电焊机、电暖器、大电流厨房设备专用



LR-210-C5N-BR

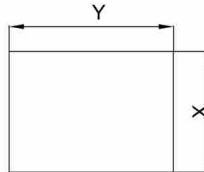
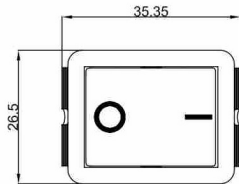

CUT-OUT

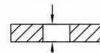

Z	X	Y
0.70~1.25	22.0~22.2	30.0~30.2
1.25~2.00	22.0~22.2	30.2~30.4
2.00~3.00	22.0~22.2	30.4~30.6

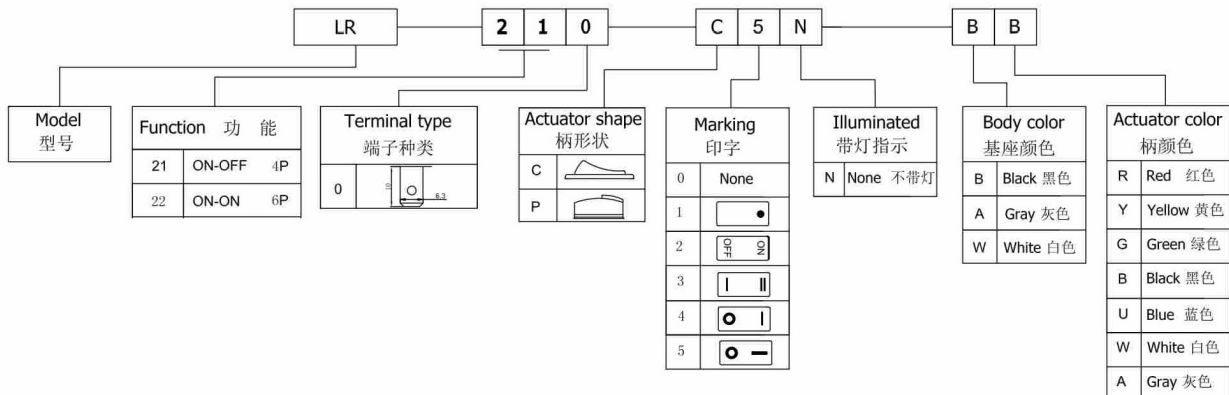
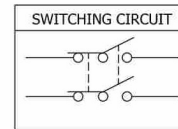
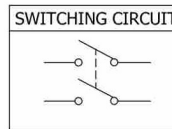
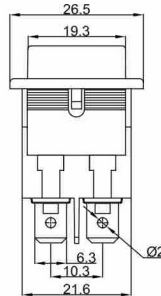
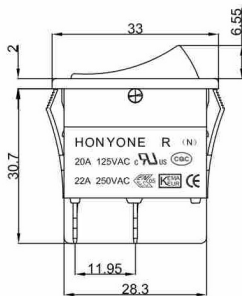

带灯轻触开关

带灯按钮开关

按钮开关

金属按钮开关

翘板开关

保险丝座

光电触摸开关

旋转开关

PR SERIES ROCKER SWITCHES

带灯轻触开关

带灯按钮开关

按钮开关

金属按钮开关

翘板开关

保险丝座

光电触摸开关

旋转开关



PR-210-P5N-BB



PR-210-P0N-BBG



PR-210-D0L-BBR



PR-210-P0N-BBR

SPECIFICATIONS

Rating	:20A 125VAC (UL) 22A 250VAC (CQC ENEC)
Degree of protection	:IP55
Contact Resistance	:20mΩ (Max)
Insulation Resistance	:DC 500V 100MΩ(Min)
Dielectric Strength	:AC 1500V 1 minute
Operating Force	:500±200gf
Mechanical Life	:50,000cycles
Load Life	:10,000 cycles
Operating Temperature	:0°C~85°C
Safety Approval	

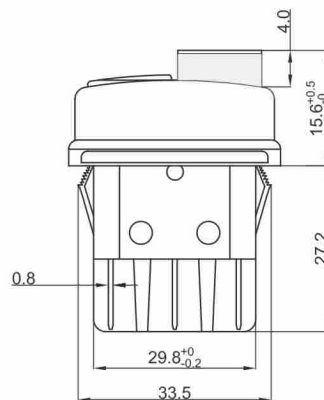
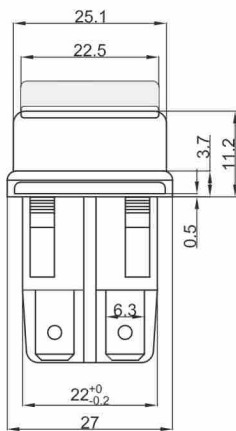
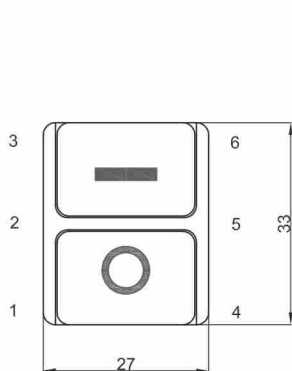
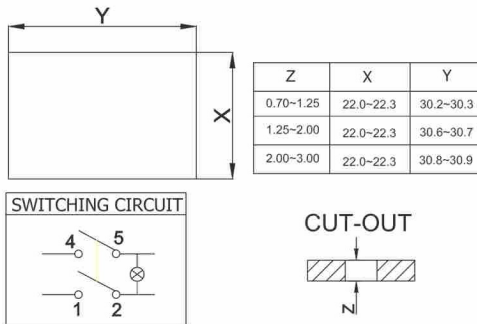

PR	2	1	0	C	5	N	B	B						
Model 型号	Function 功能		Terminal type 端子种类		Actuator shape 柄形状		Marking 印字		Illuminated 带灯指示		Body color 基座颜色		Actuator color 柄颜色	
21	ON-OFF	4P	0		P		0	None	N	None 不带灯	B	Black 黑色	R	Red 红色
22	ON-ON	6P			D		1		L	Neon 氖灯	A	Gray 灰色	Y	Yellow 黄色
							2				W	White 白色	G	Green 绿色
							3						B	Black 黑色
							4						U	Blue 蓝色
							5						W	White 白色
													A	Gray 灰色