

FEATURES

- ※BCD, Hexadecimal
- ※Cross-head& Flat-head Actuator
- ※Washable

APPLICATION

- ※Steering system
- ※White goods
- ※Wireless microphone

SPECIFICATION

Contact Rating	150mA, 24V DC
Contact Resistance	80mΩ max.
Insulation Resistance	100MΩ min. 250V DC
Dielectric Strength	250V AC/1 minute
Operating Force	400gf·cm max.
Operating Life	10,000 steps
Operating Temp.	-60°C ~ +125°C
Storage Temp.	-60°C ~ +125°C

PACKAGE

<Tube>
47 pcs
<Tape & Reel>
RBM: 450 pcs.

HOW TO ORDER

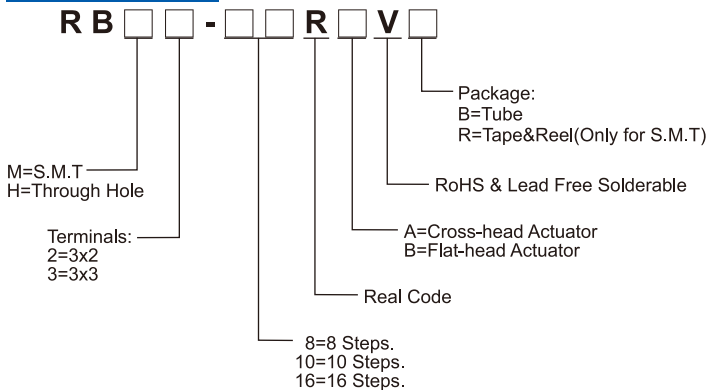

ROTARY CODED SWITCH

RBH3-□□RA

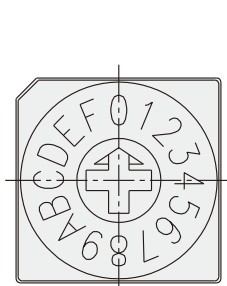

RBH3-16RA

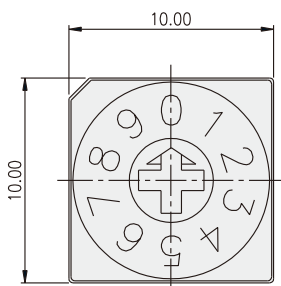

RBH3-10RA

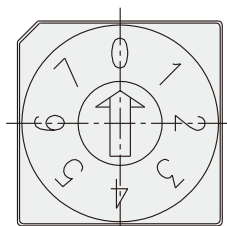
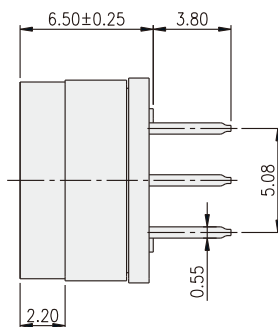

RBH3-8RB

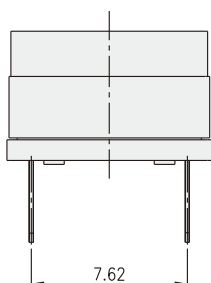

TYPE	POSITION	CODE			
		1	2	4	8
10R 08R	0	●	●	●	●
	1	○	●	●	●
	2	●	○	●	●
	3	○	○	●	●
	4	●	●	○	●
	5	○	●	○	●
	6	●	○	○	●
	7	○	○	○	●
	8	●	●	●	○
	9	○	○	●	○
16R	A	●	○	●	○
	B	○	○	●	○
	C	●	●	○	○
	D	○	●	○	○
	E	●	○	○	○
	F	○	○	○	○

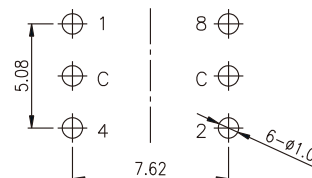

P.C.B. LAYOUT

RBH2-□□RB

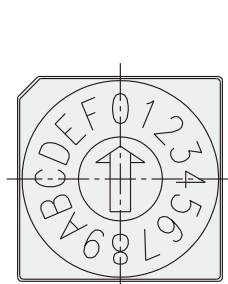

RBH2-16RB

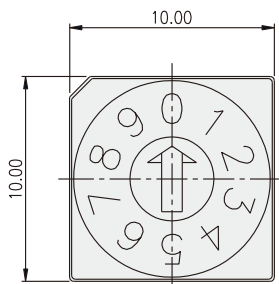

RBH2-10RB

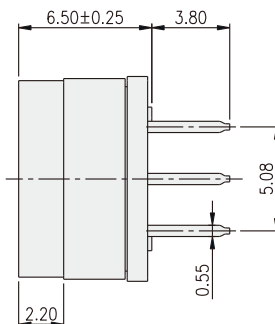

○ ON
● OFF

TYPE	POSITION	CODE			
		1	2	4	8
10R	0	●	●	●	●
	1	○	●	●	●
	2	●	○	●	●
	3	○	○	●	●
	4	●	●	○	●
	5	○	●	○	●
	6	●	○	○	●
	7	○	○	○	●
	8	●	●	●	○
	9	○	●	●	○
16R	A	●	○	●	○
	B	○	○	●	○
	C	●	●	○	○
	D	○	●	○	○
	E	●	○	○	○
	F	○	○	○	○

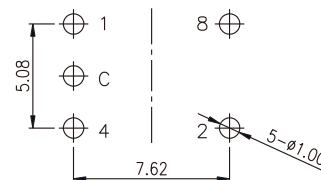
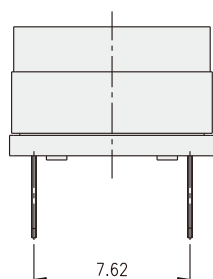

P.C.B. LAYOUT

RBM3-□□RB

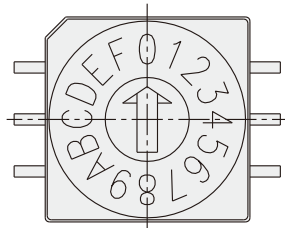

RBM3-16RB

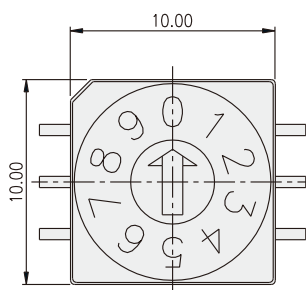

RBM3-10RB

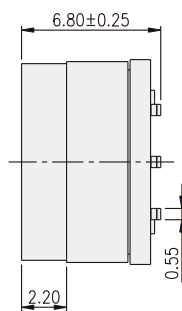

○ ON
● OFF

TYPE	POSITION	CODE			
		1	2	4	8
10R	0	●	●	●	●
	1	○	●	●	●
	2	●	○	●	●
	3	○	○	●	●
	4	●	●	○	●
	5	○	●	○	●
	6	●	○	○	●
	7	○	○	○	●
	8	●	●	●	○
	9	○	●	●	○
16R	A	●	○	●	○
	B	○	○	●	○
	C	●	●	○	○
	D	○	●	○	○
	E	●	○	○	○
	F	○	○	○	○

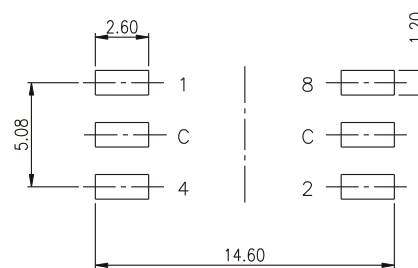
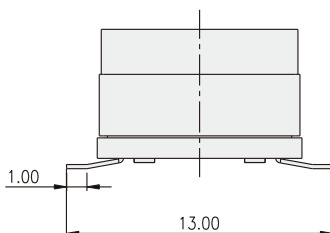

P.C.B. LAYOUT

ROTARY CODED SWITCH