

TS6 SERIES LED TACT SWITCHES



TS6-A-00-BTY-0-1



TS6-A-00-ATU-0-1



TS6-A-2B-1TR-0-1



TS6-A-1B-1TU-0-1



TS6-A-00-9TU-0-1



TS6-A-00-6SU-7-5



TS6-A-4B-3TG-0-1



TS6-A-SB-1SY-8-2

SPECIFICATIONS

Circuit	: DPDT 2P2T
Current Rating	: 100mA
Voltage Rating	: 30VDC
Dielectric withstanding voltage	: 250VAC for 1 minute
Contact Resistance	: 100mΩ Max .(initial)
Insulation Resistance	: 100MΩ Min.
Operating Force	: 150±100(MOM)
Total Travel	: 1.6±0.4mm
Operating life	: 50,000 Cycles Min
Solder Specifications	: 260°C for 5 Seconds
Function	: Momentary or self-lock
Operating Temperature	: -20°C~ +70°C



TS6-A-00-00R-0-1

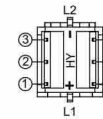
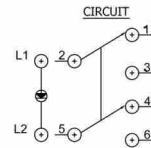
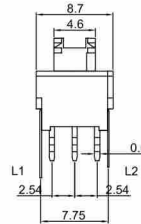
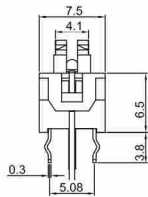

TS6-A-2B-1TW-0-1

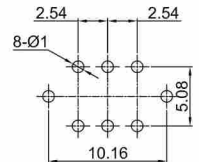
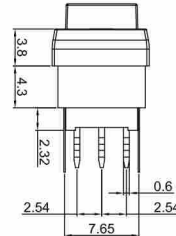
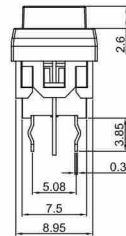
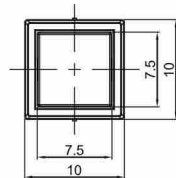

TS6	M	0 0	0 0 N	0	1			
Model 型号	Function 功能	Frame Type 外框形状	Frame Color 外框颜色	Cap Type 上盖形状	Cap Color 上盖颜色	LED Color 灯颜色	Cap Pattern 上盖图案	Terminal Type 端子类型
M	Momentary 复位	0 Without Frame	0 Without Frame	0 Without Cap	0 Without Cap	N Without LED	- NONE	1
A	Alternate 自锁	1	B Black 黑色	1	W White 白色	R Red 红灯 圆头	1	1
		2	A Gray 灰色	2	R Red 红色	Y Yellow 黄灯 圆头	2	2
		3	S Silver 银色	3	G Green 绿色	G Green 绿灯 圆头	3	3
		4		4	B Black 黑色	U Blue 蓝灯 圆头	4	4
				5	A Gray 灰色	W White 白灯 圆头	5	5
				6	Y Yellow 黄色	O Orange 橙色 圆头	6	6
				7	T Transparence 透明	R/G Red/Green 红绿双色		
				8	O Orange 橙色	R/U Red/Blue 红蓝双色		
				9	S Silver 银色			
				A				
				B				
				C				
				D				

带灯轻触开关

带灯按钮开关

按钮开关

金属按钮开关

翘板开关

保险插座

光电触摸开关

旋转开关



TS6-A-00-DTRG-0-1

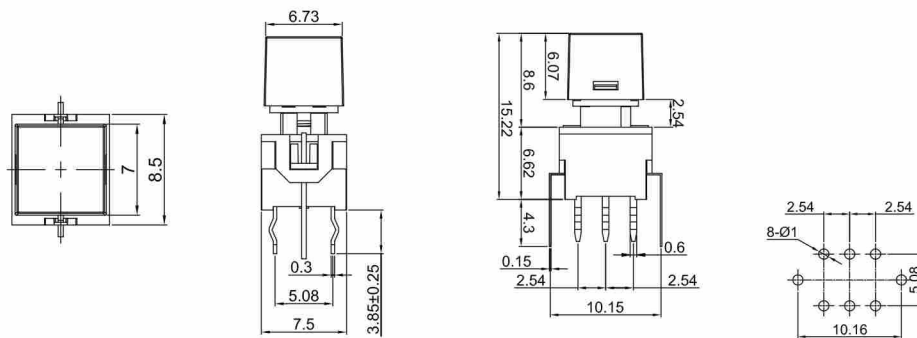

TS6-A-00-CTRG-0-1

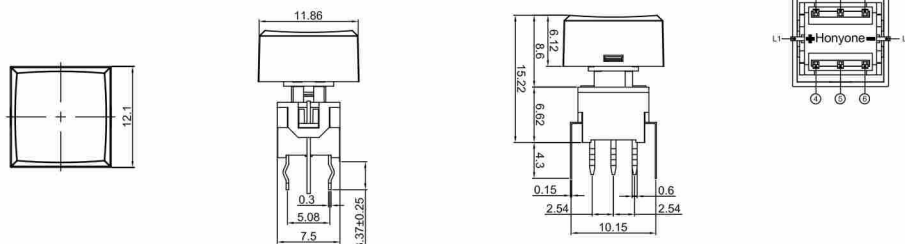

TS6-A-00-6TO-0-1

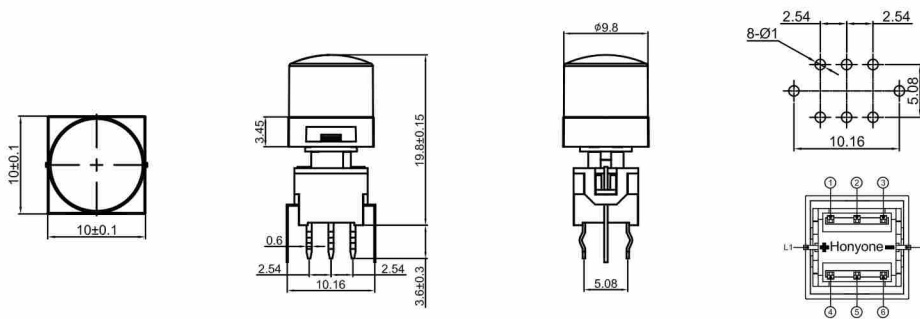

TS6-A-00-7TU-0-1

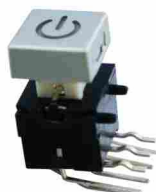
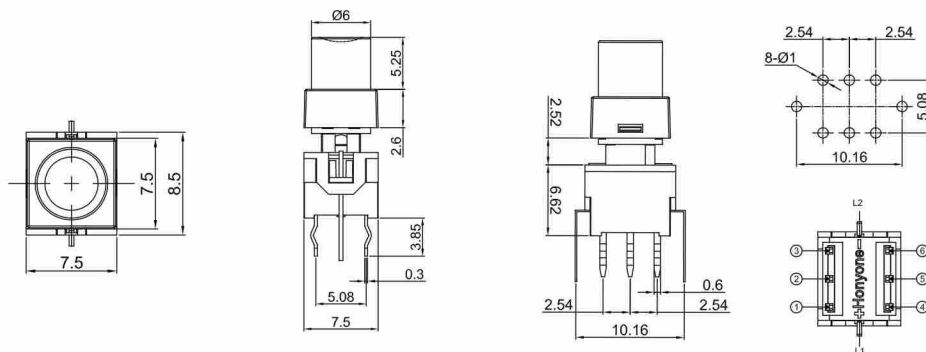

TS6-A-00-1SU-1-2

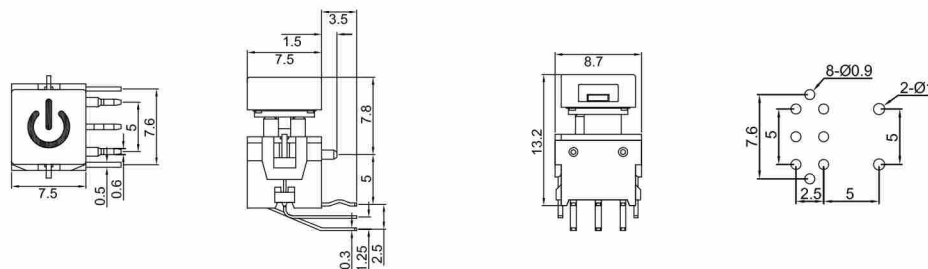

带灯轻触开关

带灯按钮开关

按钮开关

金属按钮开关

翘板开关

保险丝座

光电触摸开关

旋转开关

TS5 SERIES LED TACT SWITCHES



TS5-1WW-11S



TS5-2TG-8A-11S



TS5-1WG-11S



TS5-2TR-11S

SPECIFICATIONS

Circuit	: SPST 1P1T
Current Rating	: 50mA
Voltage Rating	: 12VDC
Dielectric withstanding voltage	: 250VAC for 1 minute
Contact Resistance	: 100mΩ Max. (initial)
Insulation Resistance	: 100MΩ Min.
Operating Force	: 180±50gf or 250±50gf
Total Travel	: 0.25±0.1mm
Operating life	: 200,000 Cycles Min
Solder Specifications	: 260°C for 3 Seconds
Function	: Momentary
Operating Temperature	: -20°C ~ +70°C

Feature-
samll size
full color LED illuminated available
long electrical life cycles
SMT and vertical PCB terminal
Applications-
consumer products
computer products
instrumentation
communication equipments

特点:
最小尺寸
全彩LED灯色
长寿命
SMT贴片端子
应用领域:
消费电子产品
电脑周边产品
仪器仪表
通信设备

LED SPECIFICATIONS							
ATTENTION	LEDs are Electrostatic Sensitive devices	Unit	Value / LED Color				
			Blue	Green	Red	White	Yellow
FORWARD CURRENT	If	mA	20	20	20	20	20
REVERSE VOLTAGE	Vr	V	5.0	5.0	5.0	5.0	5.0
REVERSE CURRENT	Ir	μA	10	10	10	10	10
FORWARD VOLTAGE	Vf	V	2.8-3.4	1.8-2.4	1.8-2.4	2.8-3.4	1.8-2.4



TS5-1WU-11S

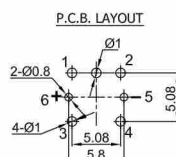
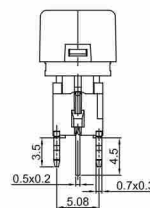
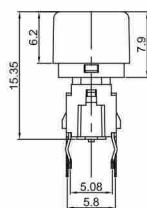
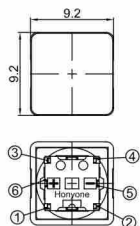

TS5-2TO-2A-11S

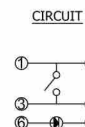
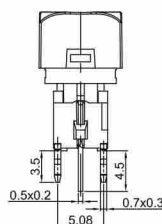
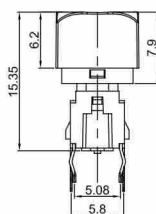
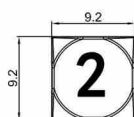

TS5	1	T	N	1	A	1	1	S
Model 型号	Cap Type 上盖形状	Cap Color 上盖颜色	LED Color 灯颜色	Cap Pattern 上盖图案	Pattern orientation 图案方向	Key-press Type 按键类型	Snap Force 弹片力度	Terminal shape 端子形状
1	白色	R 红色 Y 黄色 G 绿色 U 蓝色 W 白色 T 透明	N Without LED R Red 红灯 Y Yellow 黄灯 G Green 绿灯 U Blue 蓝灯 W White 白灯	- NONE 1 1 2 2 3 3 4 4 5 5 6 6 7 7 8 8 9 AFV 10 开启 11 Fade 12 Cube 13 14 15	- Angle For Example - NONE NONE A 0° + B 90° + C 180° + D 270° +	1 180gf 2 250gf	S	
<p>注:</p> <p>图案方向示意图</p>								

带灯轻触开关

带灯按钮开关

按钮开关

金属按钮开关

翘板开关

保险丝座

光电触摸开关

旋转开关