

# HIGH FREQUENCY CURRENT SENSING TRANSFORMER

## FACTE4.2 SERIES

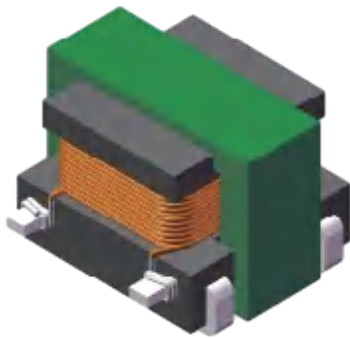

### ELECTRICAL SPECIFICATION

- Primary current of 7 A causes less than 35°C temperature rise from 25°C ambient. Higher current causes a greater temperature rise
- Operating temperature: -40°C to +120°C
- Storage temperature Component: -40°C to +165°C
- Inductance measured between secondary pins at 100kHz, 0.1 Vrms, 0 Adc
- Inductance measured at OAdc on HP 4284A LCR Meter or equivalent
- DCR measured on Chroma 16502 microohmmeter or equivalent
- Electrical specifications at 25°C

### FEATURES

- Very low DC resistance
- Different turns ratios
- Very small package
- RoHS compatible
- 500Vrms, one minute isolation (hipot) between windings
- Sensed Current - primary rated for 7 Amps

### APPLICATIONS

- Switching power supplies
- feedback control
- overload sensing
- Load drop/shut down detection

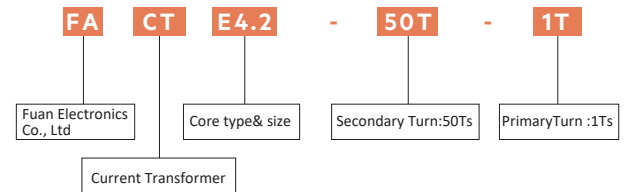

### ELECTRICAL CHARACTERISTICS FORM

Part Number	Turns ratio sec:pri	Secondary Inductance @100KHZ0.1V (uH)MIN	DCR(Ω)		Sensed Current(A) (Max)
			Sec Max	Pri Ref	
FACTE4.2-20T-1T	20:1	33	0.35	0.003	7
FACTE4.2-30T-1T	30:1	74	0.80	0.003	7
FACTE4.2-40T-1T	40:1	132	1.60	0.003	7
FACTE4.2-50T-1T	50:1	205	2.50	0.003	7
FACTE4.2-60T-1T	60:1	295	3.60	0.003	7
FACTE4.2-70T-1T	70:1	400	4.60	0.003	7
FACTE4.2-100T-1T	100:1	820	9.50	0.003	7
FACTE4.2-125T-1T	125:1	1280	13.0	0.003	7
FACTE4.2-150T-1T	150:1	1840	21.0	0.003	7

## Product datasheet

### ELECTRICAL INFORMATION

Dimension in mm

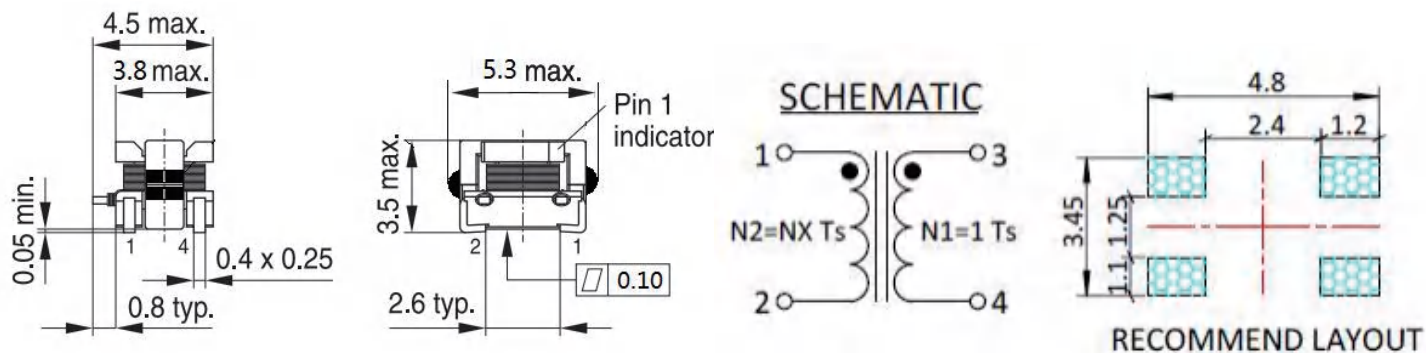

### CURRENT VS TEMPERATURE RISE

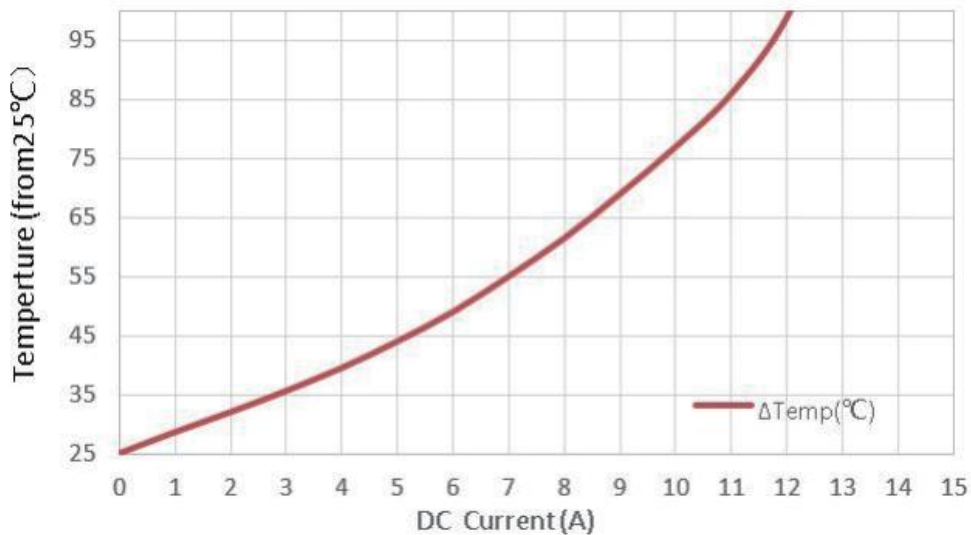

# HIGH FREQUENCY CURRENT SENSING TRANSFORMER

## FACTE4.2B SERIES

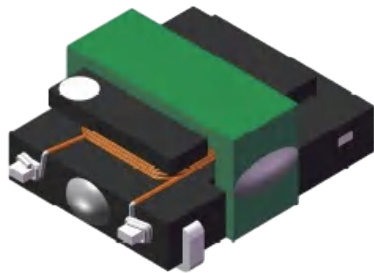

### ELECTRICAL SPECIFICATION

- Primary current of 9 A causes less than 40°C temperature rise from 25°C ambient. Higher current causes a greater temperature rise
- Operating temperature: -40°C to +125°C
- Storage temperature Component: -40°C to +165°C
- Inductance measured between secondary pins at 100kHz, 0.1 Vrms, 0 Adc
- Inductance measured at OAdc on HP 4284A LCR Meter or equivalent
- DCR measured on Chroma 16502 microohmmeter or equivalent
- Electrical specifications at 25°C

### FEATURES

- Very low DC resistance
- Different turns ratios
- Very small package
- RoHS compatible
- 500Vrms, one minute isolation (hipot) between windings
- Sensed Current - primary rated for 20 Amps

### APPLICATIONS

- Switching power supplies
- feedback control
- overload sensing
- Load drop/shut down detection

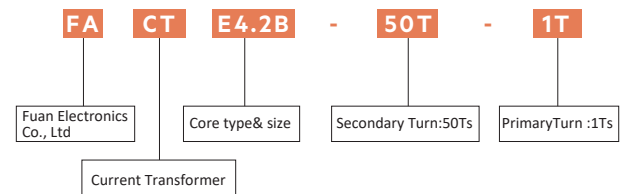

### ELECTRICAL CHARACTERISTICS FORM

Part Number	Turns ratio sec:pri	Secondary Inductance @100KHZ0.1V (mH)MIN	DCR(Ω)		Sensed Current(A) (Max)
			Sec Max	Pri Ref	
FACTE4.2B-20T-1T	20:1	0.053	0.42	0.0015	9
FACTE4.2B-50T-1T	50:1	0.333	2.76	0.0015	9
FACTE4.2B-70T-1T	70:1	0.652	5.04	0.0015	9
FACTE4.2B-100T-1T	100:1	1.330	10.68	0.0015	9
FACTE4.2B-150T-1T	150:1	2.993	22.30	0.0015	9

## Product datasheet

### ELECTRICAL INFORMATION

Dimension in mm

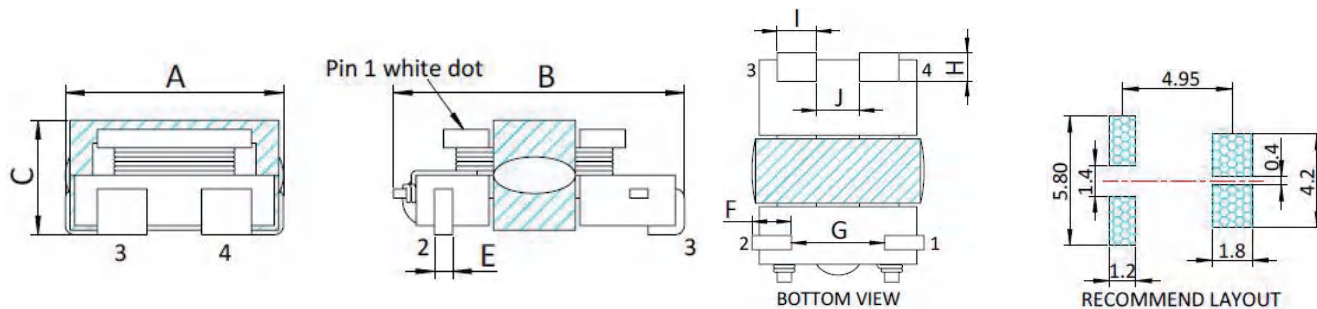

Item	A MAX.	B MAX.	C MAX.
FACTE4.2B	5.40	7.20	3.00

Item	E	F	G	H	I	J
FACTE4.2B	0.4	1.2	2.6	1.2	1.1	1.2

### CURRENT VS TEMPERATURE RISE

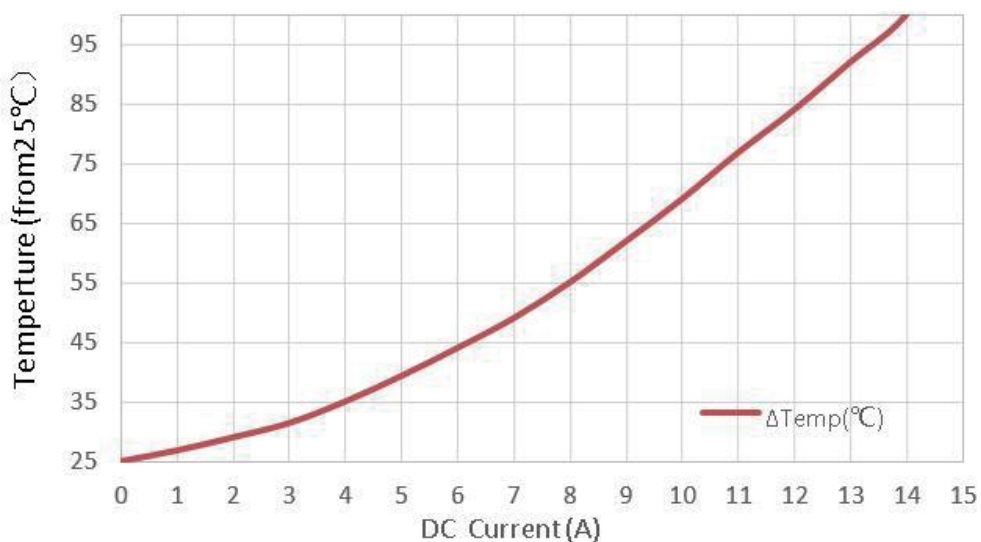

# HIGH FREQUENCY CURRENT SENSING TRANSFORMER

## FACTE5 SERIES



### ELECTRICAL SPECIFICATION

- Temperature Rise Current(Irms):The current when temperature of coil increases up to max.  $\Delta T=40^{\circ}C$ . ( $T_a=20^{\circ}C$ )
- Operating temperature:  $-40^{\circ}C$  to  $+125^{\circ}C$
- L: HP4284A PRECISION LCR METER
- DCR: CHENHWA 502 OHM METER
- Electrical specifications at  $25^{\circ}C$

### FEATURES

- Very low DC resistance
- Different turns ratios
- Small package
- RoHS compatible
- Other pinning on request

### APPLICATIONS

- Switching power supplies
- feedback control
- overload sensing
- Load drop/shut down detection

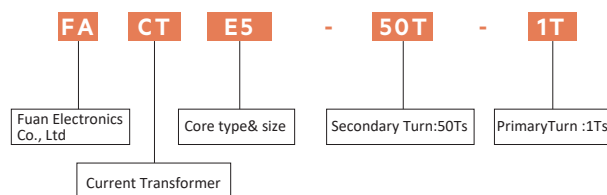

### ELECTRICAL CHARACTERISTICS FORM

Part Number	Turns ratio sec:pri	Secondary Inductance @100KHZ0.1V (uH)MIN	DCR( $\Omega$ )		Sensed Current(A) (Max)
			Sec Max	Pri Ref	
FACTE5-20T-1T	20:1	80	0.40	0.0007	10/20
FACTE5-30T-1T	30:1	180	0.87	0.0007	10/20
FACTE5-40T-1T	40:1	320	1.14	0.0007	10/20
FACTE5-50T-1T	50:1	500	1.85	0.0007	10/20
FACTE5-60T-1T	60:1	730	2.30	0.0007	10/20
FACTE5-70T-1T	70:1	980	4.75	0.0007	10/20
FACTE5-100T-1T	100:1	2000	5.50	0.0007	10/20
FACTE5-125T-1T	125:1	3000	11.50	0.0007	10/20

# Product datasheet

## ELECTRICAL INFORMATION

Dimension in mm

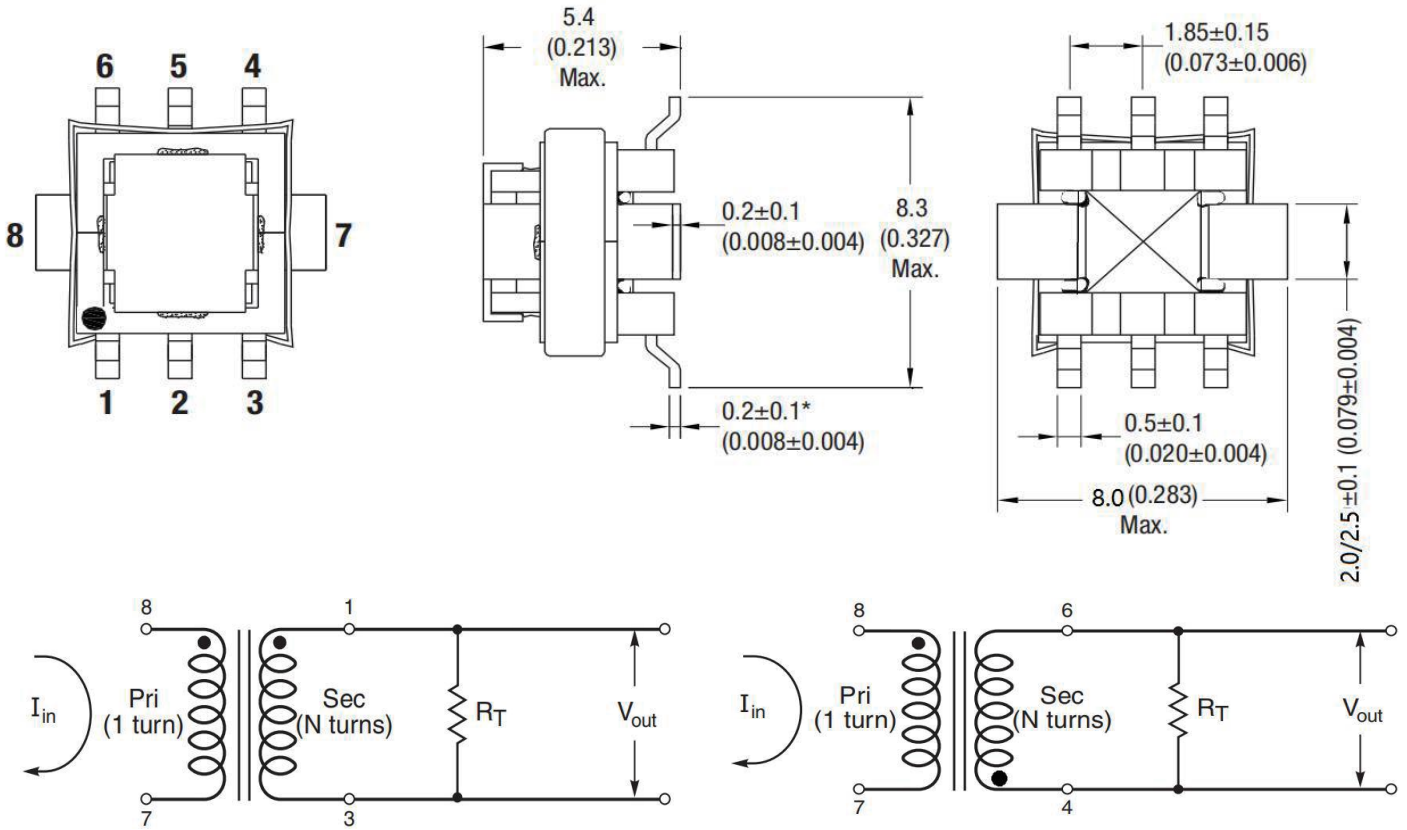

## CURRENT VS TEMPERATURE RISE

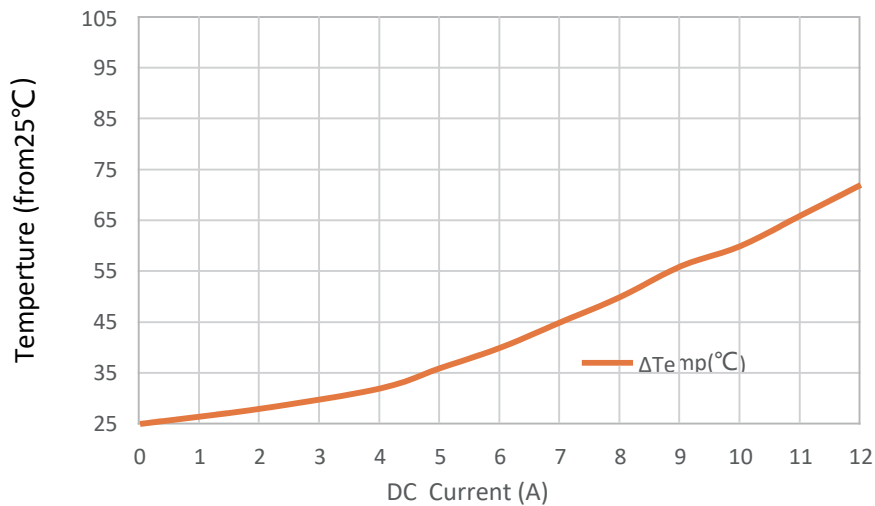

## HIGH FREQUENCY CURRENT SENSING TRANSFORMER

### FACTE6 SERIES

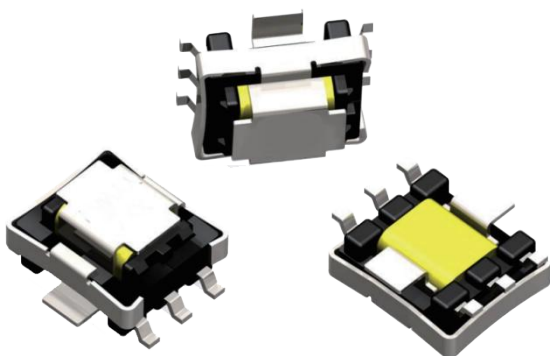

#### ELECTRICAL SPECIFICATION

- Temperature Rise Current(Irms):The current when temperature of coil increases up to max.  $\Delta T=40^{\circ}\text{C}$ . ( $T_a=20^{\circ}\text{C}$ )
- Operating temperature:  $-40^{\circ}\text{C}$  to  $+125^{\circ}\text{C}$
- L: HP4284A PRECISION LCR METER
- DCR: CHENHWA 502 OHM METER
- Electrical specifications at  $25^{\circ}\text{C}$

#### FEATURES

- Very low DC resistance
- Different turns ratios
- Small package
- RoHS compatible
- Other pinning on request

#### APPLICATIONS

- Switching power supplies
- feedback control
- overload sensing
- Load drop/shut down detection

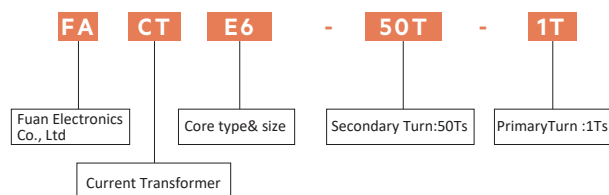

#### ELECTRICAL CHARACTERISTICS FORM

Part Number	Turns ratio sec:pri	Secondary Inductance @100KHZ0.1V (uH)MIN	DCR( $\Omega$ )		Sensed Current(A) (Max)
			Sec Max	Pri Ref	
FACTE6-50T-1T	50:1	352	0.90	0.0007	20
FACTE6-70T-1T	70:1	690	1.70	0.0007	20
FACTE6-100T-1T	100:1	1400	3.00	0.0007	20
FACTE6-125T-1T	125:1	2200	5.00	0.0007	20

## Product datasheet

### ELECTRICAL INFORMATION

Dimension in mm

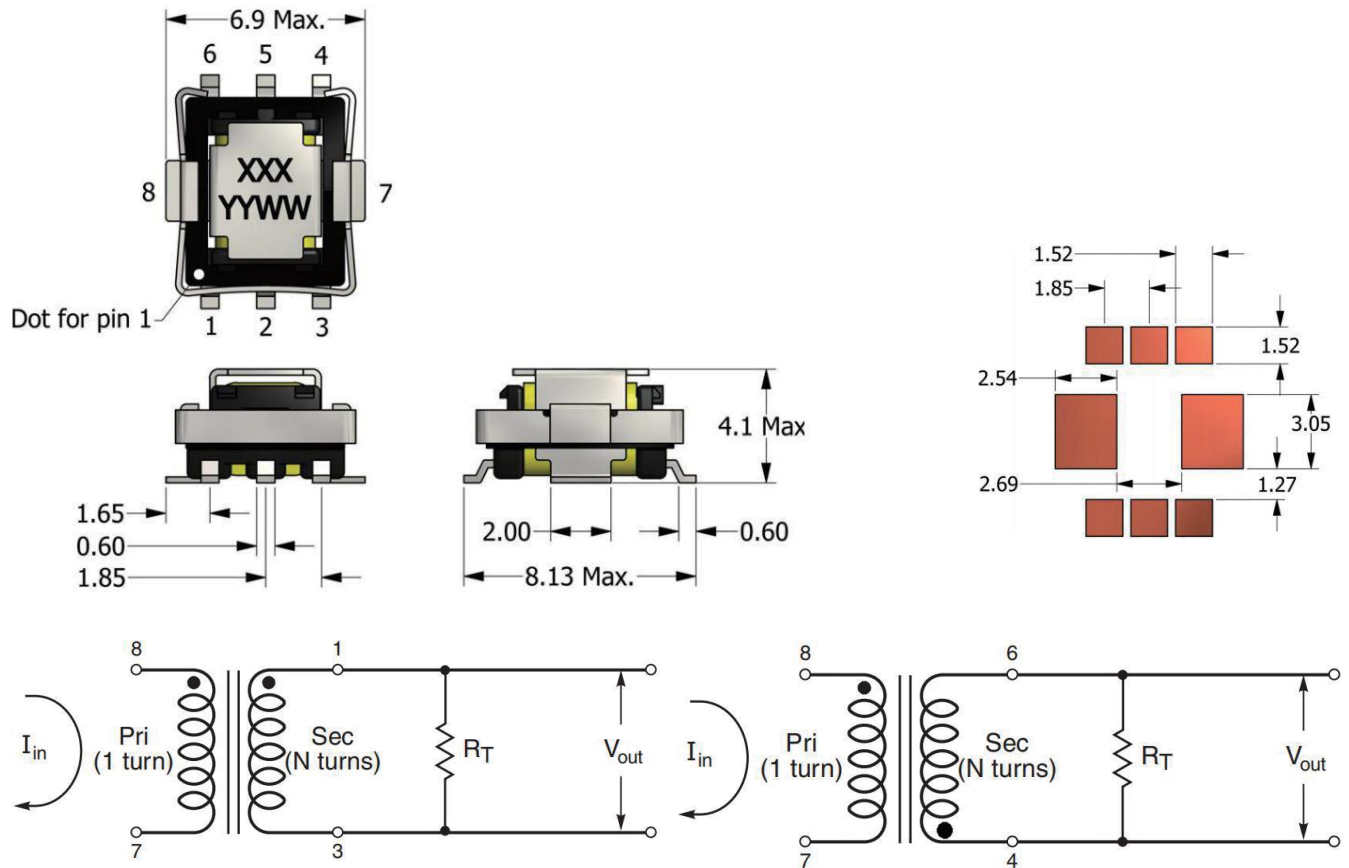

### CURRENT VS TEMPERATURE RISE

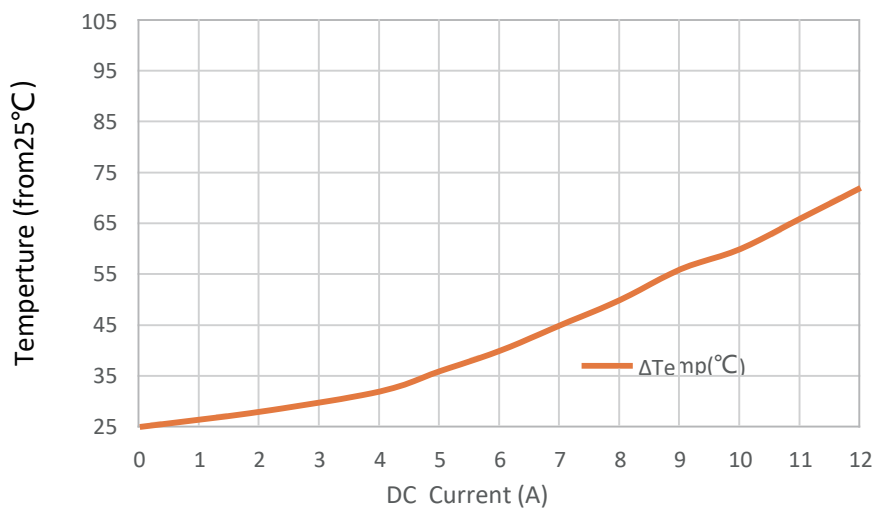



## HIGH FREQUENCY CURRENT SENSING TRANSFORMER

### FACTE6B SERIES

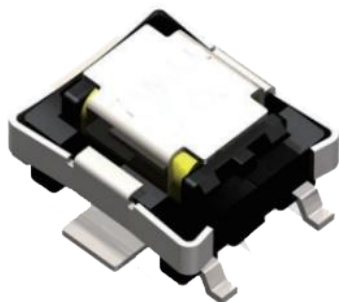

#### ELECTRICAL SPECIFICATION

- Temperature Rise Current(Irms):The current when temperature of coil increases up to max.  $\Delta T=40^{\circ}C$ . ( $T_a=20^{\circ}C$ )
- Operating temperature:  $-40^{\circ}C$  to  $+125^{\circ}C$
- L: HP4284A PRECISION LCR METER
- DCR: CHENHWA 502 OHM METER
- Electrical specifications at  $25^{\circ}C$

#### FEATURES

- Very low DC resistance
- Different turns ratios
- Small package
- RoHS compatible
- Other pinning on request

#### APPLICATIONS

- Switching power supplies
- feedback control
- overload sensing
- Load drop/shut down detection

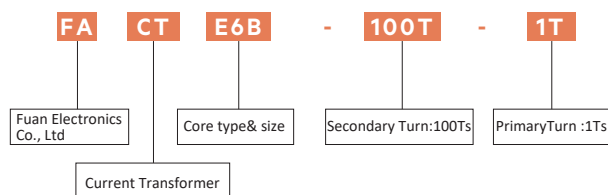

#### ELECTRICAL CHARACTERISTICS FORM

Part Number	Turns ratio sec:pri	Secondary Inductance @100KHZ0.1V (uH)MIN	DCR( $\Omega$ )		Sensed Current(A) (Max)
			Sec Max	Pri Ref	
FACTE6B-100T-1T	100:1	800	0.90	0.0007	10

## Product datasheet

### ELECTRICAL INFORMATION

Dimension in mm

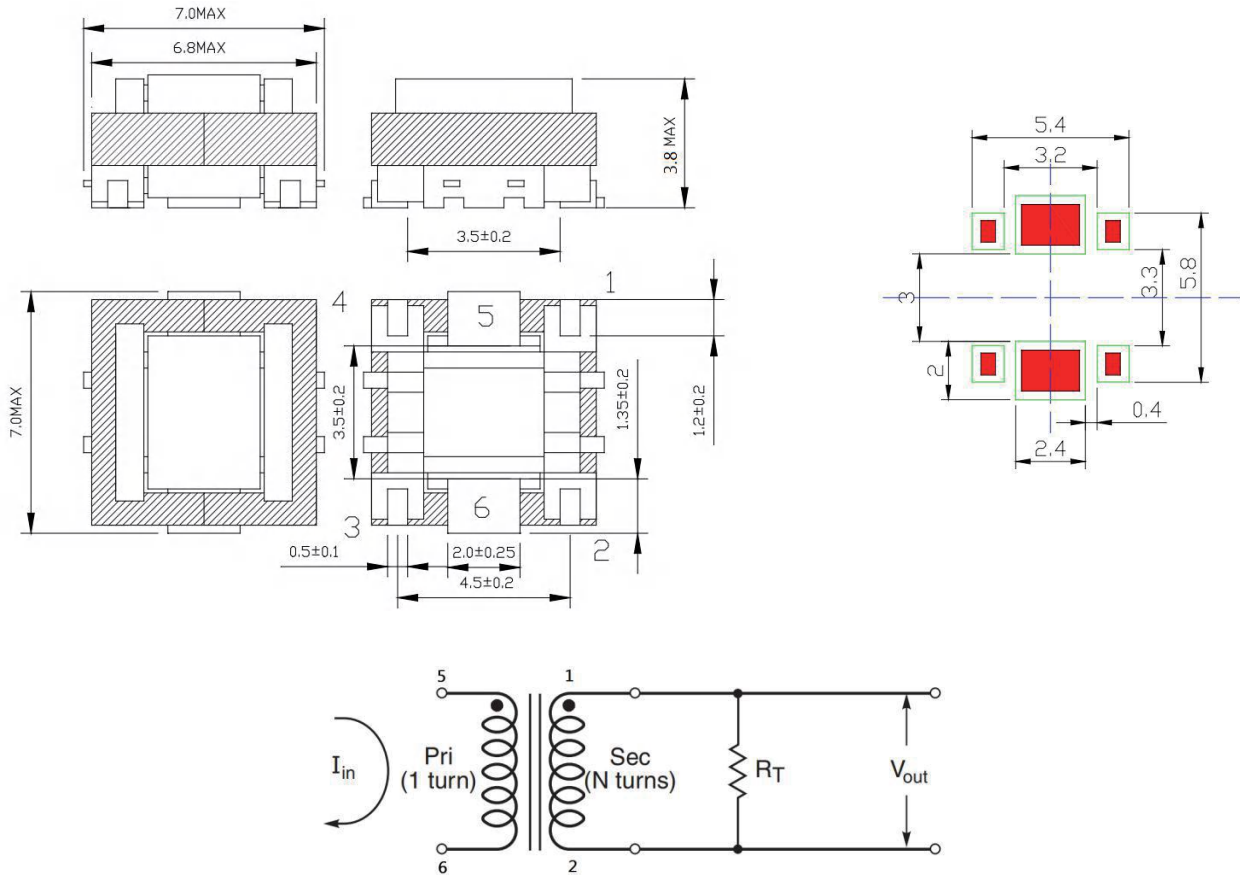

### CURRENT VS TEMPERATURE RISE

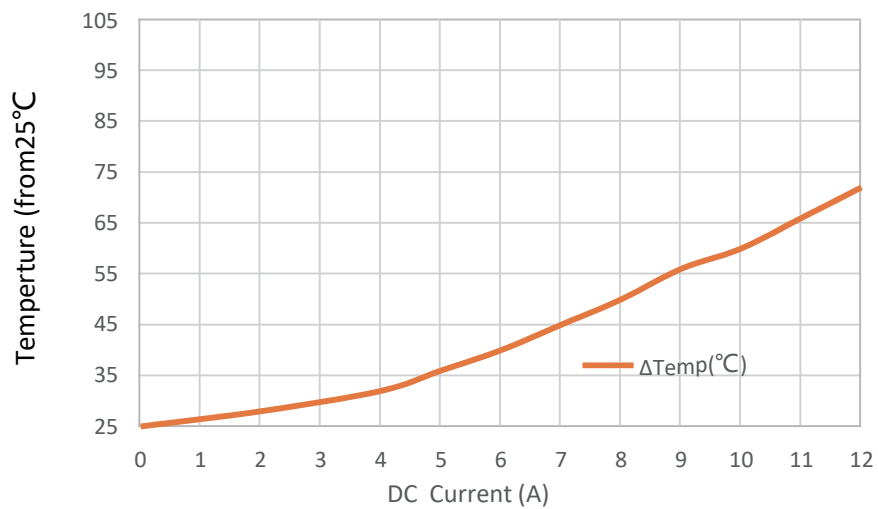

# HIGH FREQUENCY CURRENT SENSING TRANSFORMER

## FACTE8A SERIES

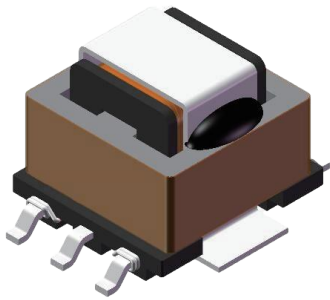

### ELECTRICAL SPECIFICATION

- Temperature Rise Current(Irms):The current when temperature of coil increases up to max.  $\Delta T=40^{\circ}C$ . ( $T_a=20^{\circ}C$ )
- Operating temperature:  $-40^{\circ}C$  to  $+125^{\circ}C$
- L: HP4284A PRECISION LCR METER
- DCR: CHENHWA 502 OHM METER
- Electrical specifications at  $25^{\circ}C$

### FEATURES

- Very low DC resistance
- Different turns ratios
- Small package
- Other pinning on request

### APPLICATIONS

- Power supply for VTRs
- Small surface mount current sensors
- Sensed current up to 30 A;  
Frequency range up to 1MHz
- Very low primary DC resistance
- 1.0KV DC/3mA / 1S isolation (hipot)  
between windings
- LCD televisions、 Notebook PCs、  
Portable communication equipment、  
DC/DC converters,m etc

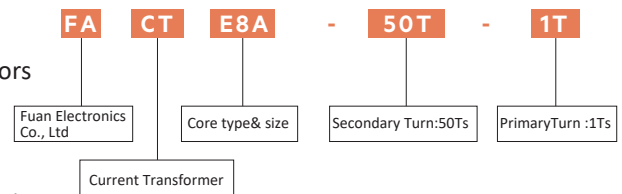

### ELECTRICAL CHARACTERISTICS FORM

Part Number	Turns ratio sec:pri	Secondary Inductance @100KHZ0.1V (mH)MIN	DCR( $\Omega$ )		Sensed Current(A) (Max)
			Sec Max	Pri Ref	
FACTE8A-50T-1T	50:1	0.63	0.60	0.0039	30
FACTE8A-100T-1T	100:1	2.50	3.00	0.0039	30
FACTE8A-150T-1T	150:1	5.63	5.70	0.0039	30
FACTE8A-200T-1T	200:1	10.0	10.0	0.0039	30
FACTE8A-300T-1T	300:1	22.5	25.0	0.0039	30

# Product datasheet

## ELECTRICAL INFORMATION

Dimension in mm

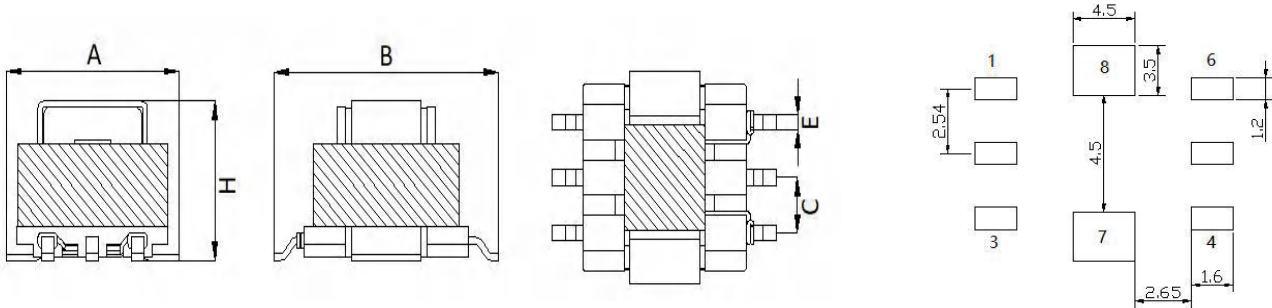

Item	A MAX.	B MAX.	H MAX.
FACTE8A	9.70	12.80	7.00

Item	C	E			
FACTE8A	2.50	1.00			

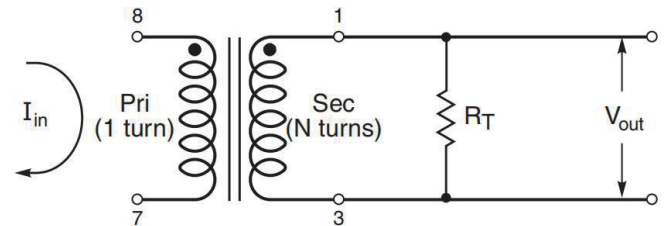
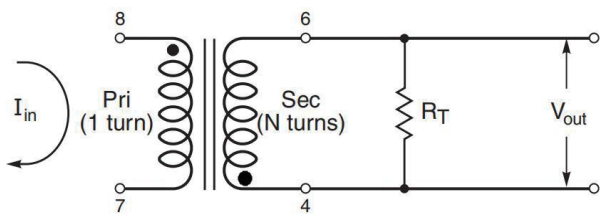

## CURRENT VS TEMPERATURE RISE

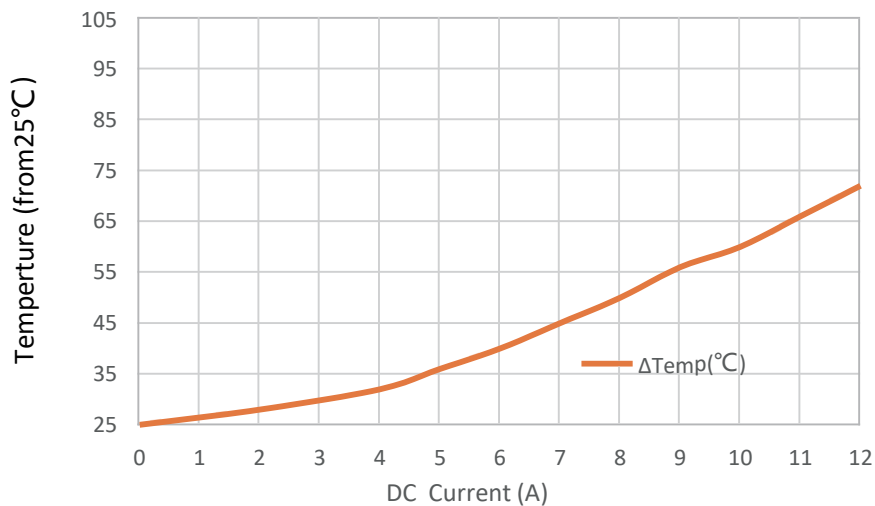

## HIGH FREQUENCY CURRENT SENSING TRANSFORMER

### FACTE8B SERIES

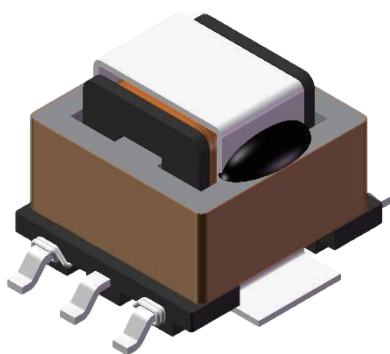

#### ELECTRICAL SPECIFICATION

- Temperature Rise Current(Irms):The current when temperature of coil increases up to max.  $\Delta T=40^{\circ}C$ . ( $T_a=20^{\circ}C$ )
- Operating temperature:  $-40^{\circ}C$  to  $+125^{\circ}C$
- L: HP4284A PRECISION LCR METER
- DCR: CHENHWA 502 OHM METER
- Electrical specifications at  $25^{\circ}C$

#### FEATURES

- Very low DC resistance
- Different turns ratios
- Small package
- Other pinning on request

#### APPLICATIONS

- Power supply for VTRs
- Small surface mount current sensors
- Sensed current up to 30 A;  
Frequency range up to 1MHz
- Very low primary DC resistance
- 1.0KV DC/3mA / 1S isolation (hipot) between windings
- LCD televisions、 Notebook PCs、  
Portable communication equipment、  
DC/DC converters,m etc

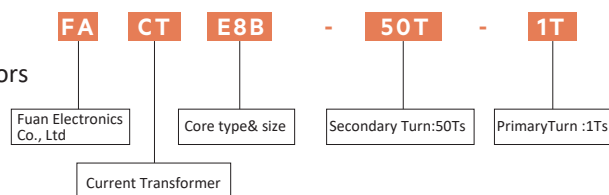

#### ELECTRICAL CHARACTERISTICS FORM

Part Number	Turns ratio sec:pri	Secondary Inductance @100KHZ0.1V (mH)MIN	DCR( $\Omega$ )		Sensed Current(A) (Max)
			Sec Max	Pri Ref	
FACTE8B-50T-1T	50:1	1.40	0.65	0.0039	30
FACTE8B-100T-1T	100:1	5.60	2.00	0.0039	30
FACTE8B-125T-1T	125:1	8.70	5.20	0.0039	30
FACTE8B-150T-1T	150:1	12.6	6.50	0.0039	30
FACTE8B-200T-1T	200:1	22.0	8.00	0.0039	30

## Product datasheet

### ELECTRICAL INFORMATION

Dimension in mm

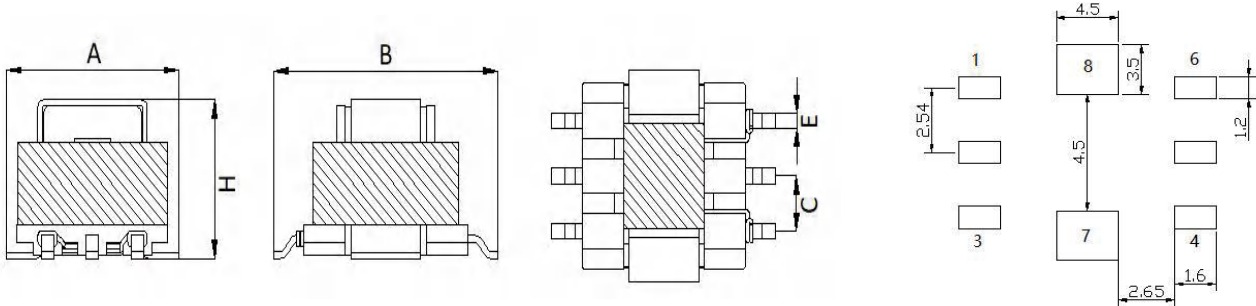

Item	A MAX.	B MAX.	H MAX.
FACTE8B	11.00	13.00	7.80

Item	C	E			
FACTE8B	2.50	0.70			

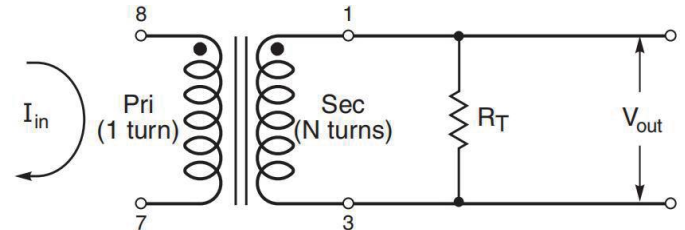
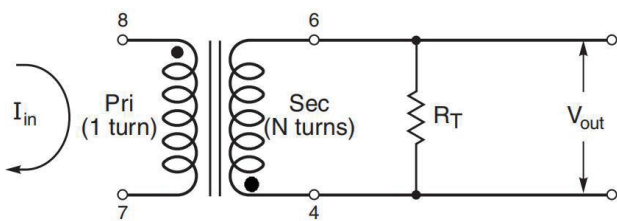

### CURRENT VS TEMPERATURE RISE

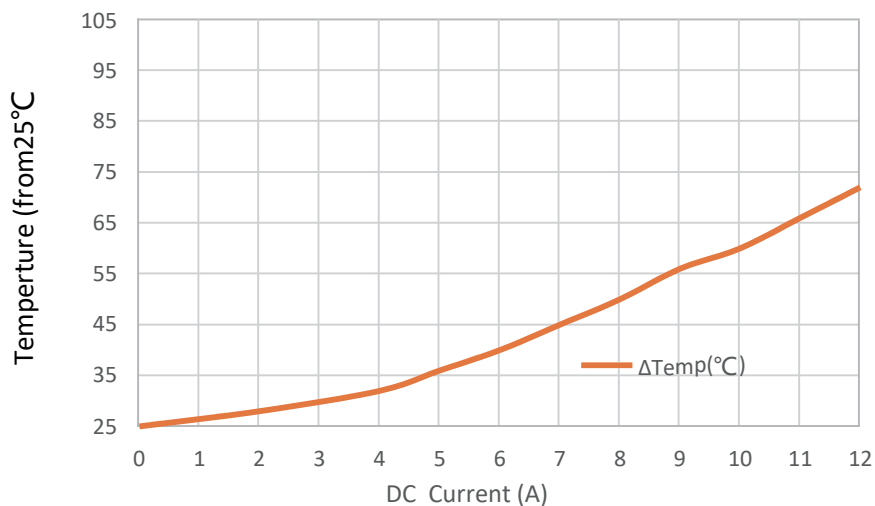

## HIGH FREQUENCY CURRENT SENSING TRANSFORMER

### FACTE8D SERIES



#### ELECTRICAL SPECIFICATION

- Frequency range: 1KHz~500KHz
- Inductance: 10KHZ 0.1V.
- D.C.Resistance: at 25°C
- Storage conditions: -20°C~+40°C,<75%RH
- Operating temperature range:-40°C~+125°C
- Weight: approx.3.0g

#### FEATURES

- Very low DC resistance
- Different turns ratios
- Very small package
- RoHS compatible

#### APPLICATIONS

- Switching power supplies
- Feedback control
- Overload sensing
- Load drop/shut down detection

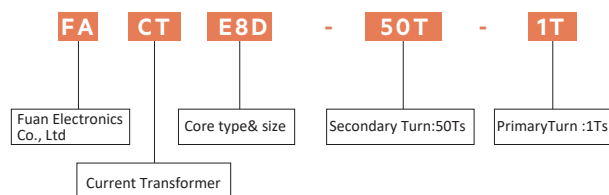

#### ELECTRICAL CHARACTERISTICS FORM

Part Number	Turns ratio sec:pri	Secondary Inductance @10KHZ0.1V (mH)MIN	DCR(Ω)		Sensed Current(A) (Max)
			Sec Max	Pri Ref	
FACTE8D-50T-1T	50:1	1.0	1.0	0.0025	10
FACTE8D-60T-1T	60:1	1.4	1.5	0.0025	10
FACTE8D-70T-1T	70:1	1.9	2.0	0.0025	10
FACTE8D-100T-1T	100:1	3.8	4.0	0.0025	10
FACTE8D-125T-1T	125:1	6.0	6.0	0.0025	10
FACTE8D-150T-1T	150:1	8.7	9.0	0.0025	10
FACTE8D-200T-1T	200:1	15.0	15.0	0.0025	10

## Product datasheet

### ELECTRICAL INFORMATION

Dimension in mm

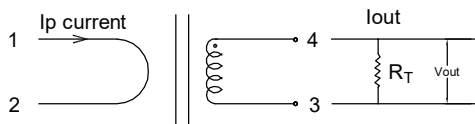
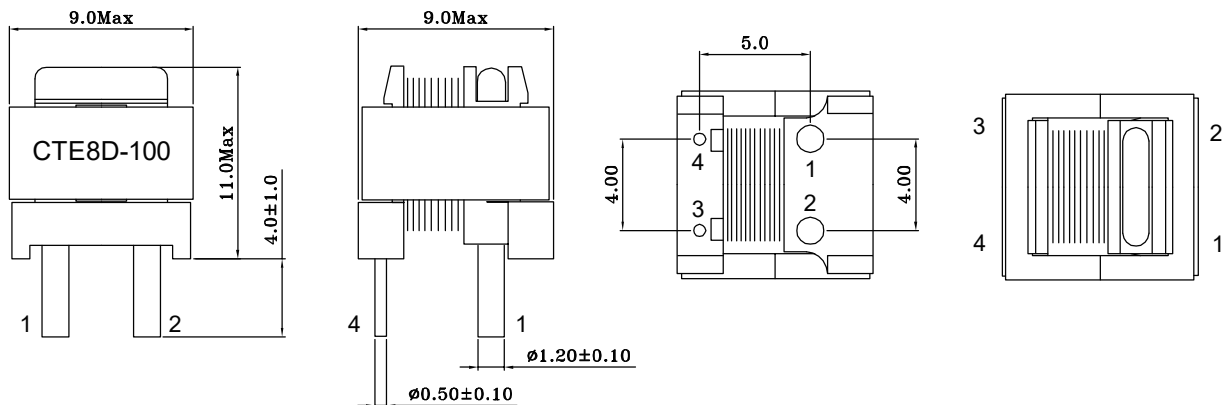



## HIGH FREQUENCY CURRENT SENSING TRANSFORMER

### FACTE10 SERIES

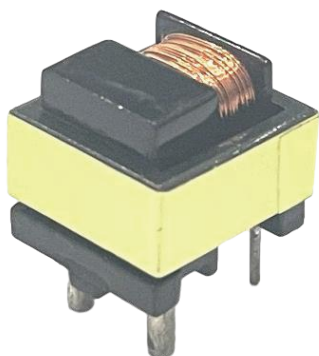

#### ELECTRICAL SPECIFICATION

- Frequency range: 1KHz~500KHz
- Inductance: 10KHZ 0.1V.
- D.C.Resistance: at 25°C
- Storage conditions: -20°C~+40°C,<75%RH
- Operating temperature range:-40°C~+125°C
- Weight: approx.3.0g

#### FEATURES

- Very low DC resistance
- Different turns ratios
- Very small package
- RoHS compatible

#### APPLICATIONS

- Switching power supplies
- Feedback control
- Overload sensing
- Load drop/shut down detection

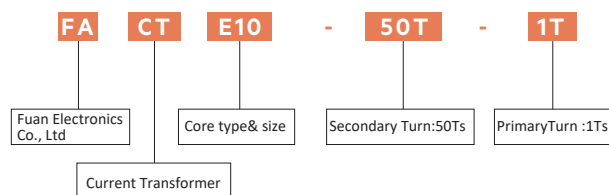

#### ELECTRICAL CHARACTERISTICS FORM

Part Number	Turns ratio sec:pri	Secondary Inductance @10KHZ0.1V (mH)MIN	DCR(Ω)		Sensed Current(A) (Max)
			Sec Max	Pri Ref	
FACTE10-50T-1T	50:1	1.75	0.65	0.0004	15
FACTE10-60T-1T	60:1	2.5	1.0	0.0004	15
FACTE10-70T-1T	70:1	3.5	1.35	0.0004	15
FACTE10-100T-1T	100:1	7.0	2.5	0.0004	15
FACTE10-125T-1T	125:1	11.0	3.5	0.0004	15
FACTE10-150T-1T	150:1	15.7	5.5	0.0004	15
FACTE10-200T-1T	200:1	28.0	10.0	0.0004	15

## Product datasheet

### ELECTRICAL INFORMATION

Dimension in mm

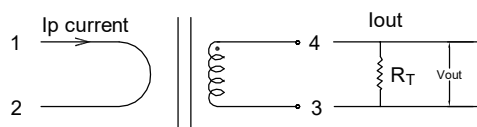
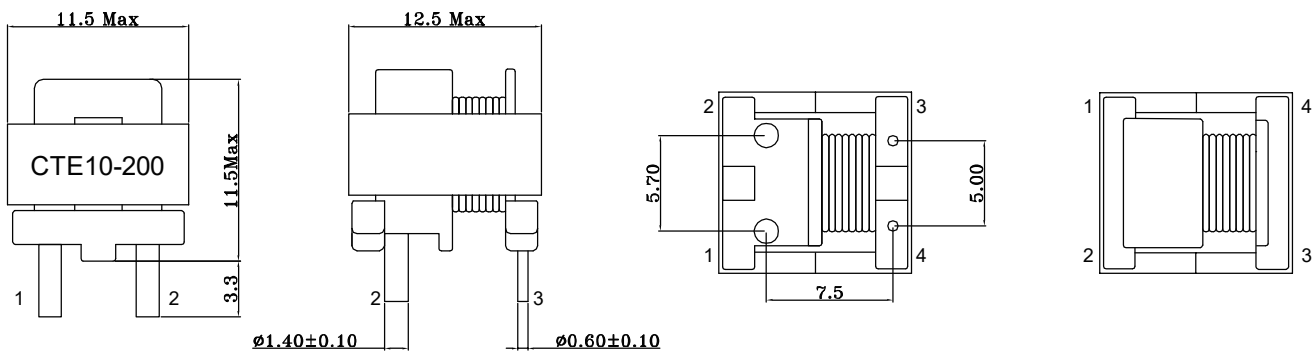

# HIGH FREQUENCY CURRENT SENSING TRANSFORMER

## FACTE12 SERIES

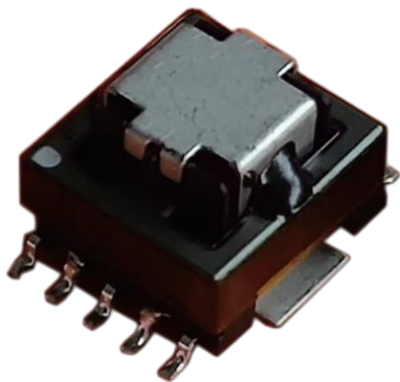

### ELECTRICAL SPECIFICATION

- Primary current of 35 A causes less than 35°C temperature rise from 25°C ambient. Higher current causes a greater temperature rise
  - Operating temperature: -40°C to +120°C
  - Storage temperature Component: -40°C to +165°C
  - Inductance measured between secondary pins at 100kHz, 0.1 Vrms, 0 Adc
  - Inductance measured at 0Adc on HP 4284A LCR Meter or equivalent
  - DCR measured on Chroma 16502 microohmmeter or equivalent
- Electrical specifications at 25°C

### FEATURES

- Very low DC resistance
- Different turns ratios
- Very small package
- RoHS compatible
- 1000Vrms, one minute isolation (hipot) between windings temperature rise from 25°C ambient. Higher current causes a greater temperature rise

### APPLICATIONS

- Power supply for VTRs
- Small surface mount current sensors
- Sensed current up to 35 A; Frequency range up to 1MHz
- Very low primary DC resistance
- 1.0KV DC/3mA / 1S isolation (hipot) between windings
- LCD televisions, Notebook PCs, Portable communication equipment, DC/DC converters, etc

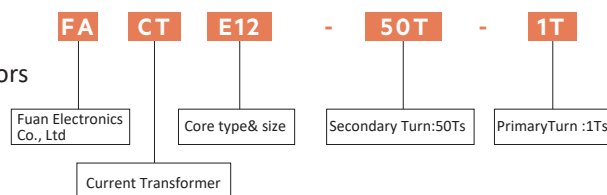

### ELECTRICAL CHARACTERISTICS FORM

Part Number	Turns ratio sec:pri	Secondary Inductance @100KHZ0.1V (mH)MIN	DCR(Ω)		Sensed Current(A) (Max)
			Sec Max	Pri Ref	
FACTE12-50T-1T	50:1	1.40	0.70	0.0042	35
FACTE12-100T-1T	100:1	5.60	1.40	0.0042	35
FACTE12-150T-1T	150:1	12.6	2.40	0.0042	35
FACTE12-200T-1T	200:1	22.4	2.90	0.0042	35

## Product datasheet

### ELECTRICAL INFORMATION

Dimension in mm

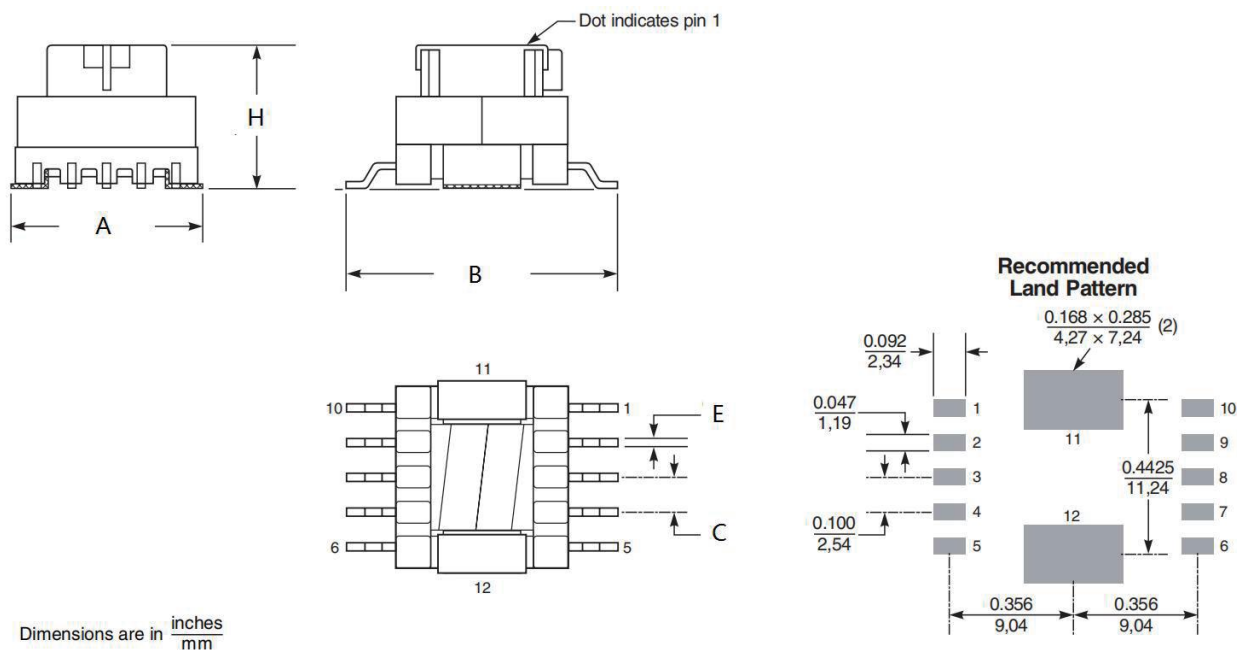

Item	A MAX.	B MAX.	C MAX.
FACTE12	15.0	20.0	2.50

Item	E	H MAX
FACTE12	0.7	10.50

### CURRENT VS TEMPERATURE RISE

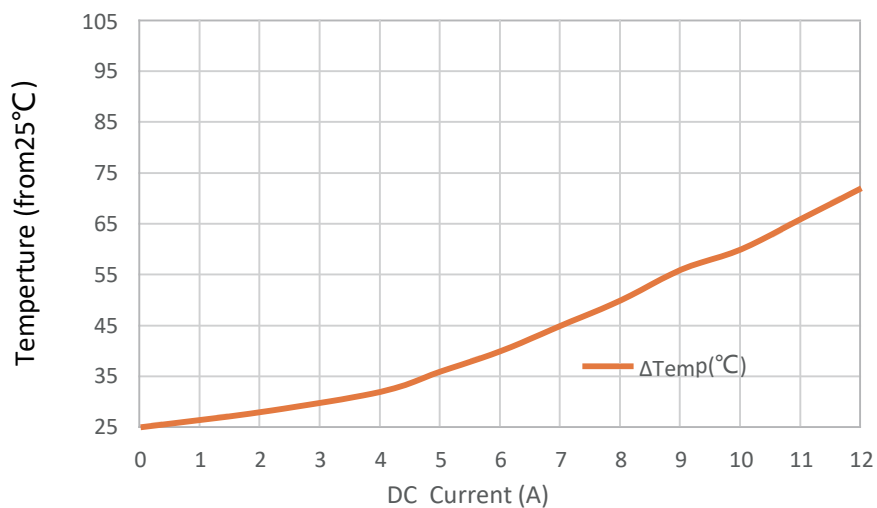

## LOW FREQUENCY CURRENT SENSING TRANSFORMER

### FACTE19 SERIES



#### ELECTRICAL SPECIFICATION

- Primary Current:0~30Amps
- $V_{out}=R_t \cdot I_p / N_s$ ,  $I_{out}=I_p / N_s$
- Frequency range: 50Hz~10KHz
- D.C.Resistance: at 25°C
- Storage conditions: -20°C~+40°C,<75%RH
- Operating temperature range:-40°C~+125°C
- Weight: approx.13.5g

#### FEATURES

- Very low DC resistance
- Different turns ratios
- Very small package
- RoHS compatible

#### APPLICATIONS

- Switching power supplies
- Feedback control
- Overload sensing
- Load drop/shut down detection

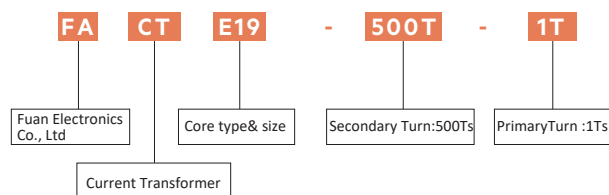

#### ELECTRICAL CHARACTERISTICS FORM

Part Number	Turns ratio sec:pri	Secondary Inductance @100KHZ0.1V (uH)MIN	DCR(Ω)		Sensed Current(A) (Max)
			Sec Max	Pri Ref	
FACTE19-500T-1T	500:1	-	22	0.003	30
FACTE19-1000T-1T	1000:1	-	90	0.003	30
FACTE19-1500T-1T	1500:1	-	200	0.003	30
FACTE19-2000T-1T	2000:1	-	350	0.003	30
FACTE19-2500T-1T	2500:1	-	600	0.003	30
FACTE19-3000T-1T	3000:1	-	750	0.003	30

## Product datasheet

### ELECTRICAL INFORMATION

Dimension in mm

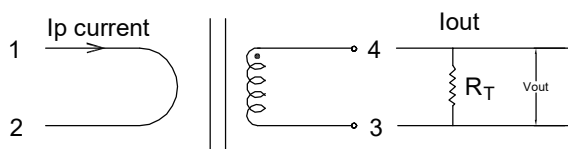
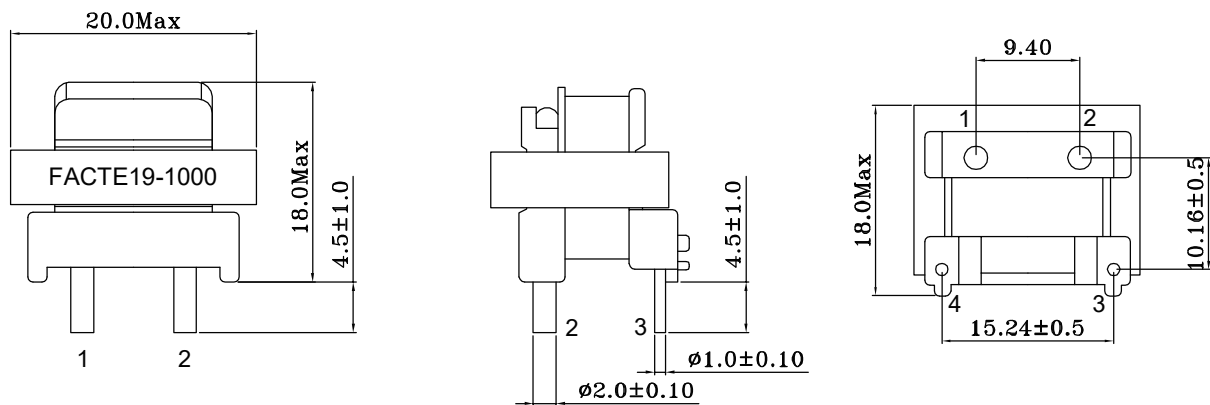

## HIGH FREQUENCY CURRENT SENSING TRANSFORMER

### FACTEP10 SERIES



#### ELECTRICAL SPECIFICATION

- Frequency range: 1KHz~500KHz
- Inductance: 10KHZ 0.1V.
- D.C.Resistance: at 25°C
- Storage conditions: -20°C~+40°C,<75%RH
- Operating temperature range:-40°C~+125°C
- Weight: approx.5.0g

#### FEATURES

- Very low DC resistance
- Different turns ratios
- Very small package
- RoHS compatible

#### APPLICATIONS

- Switching power supplies
- Feedback control
- Overload sensing
- Load drop/shut down detection

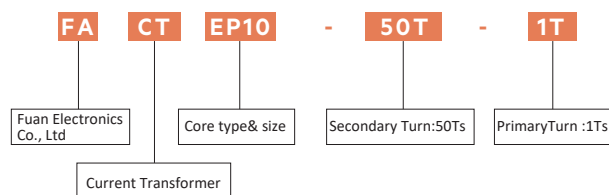

#### ELECTRICAL CHARACTERISTICS FORM

Part Number	Turns ratio sec:pri	Secondary Inductance @10KHZ0.1V (mH)MIN	DCR(Ω)		Sensed Current(A) (Max)
			Sec Max	Pri Ref	
FACTEP10-50T-1T	50:1	1.7	0.65	0.0005	30
FACTEP10-70T-1T	70:1	3.0	1.38	0.0005	30
FACTEP10-100T-1T	100:1	7.0	2.79	0.0005	30
FACTEP10-125T-1T	125:1	11.0	4.0	0.0005	30
FACTEP10-150T-1T	150:1	15.8	6.0	0.0005	30
FACTEP10-180T-1T	180:1	25.0	7.4	0.0005	30
FACTEP10-200T-1T	200:1	32.0	9.0	0.0005	30

## Product datasheet

### ELECTRICAL INFORMATION

Dimension in mm

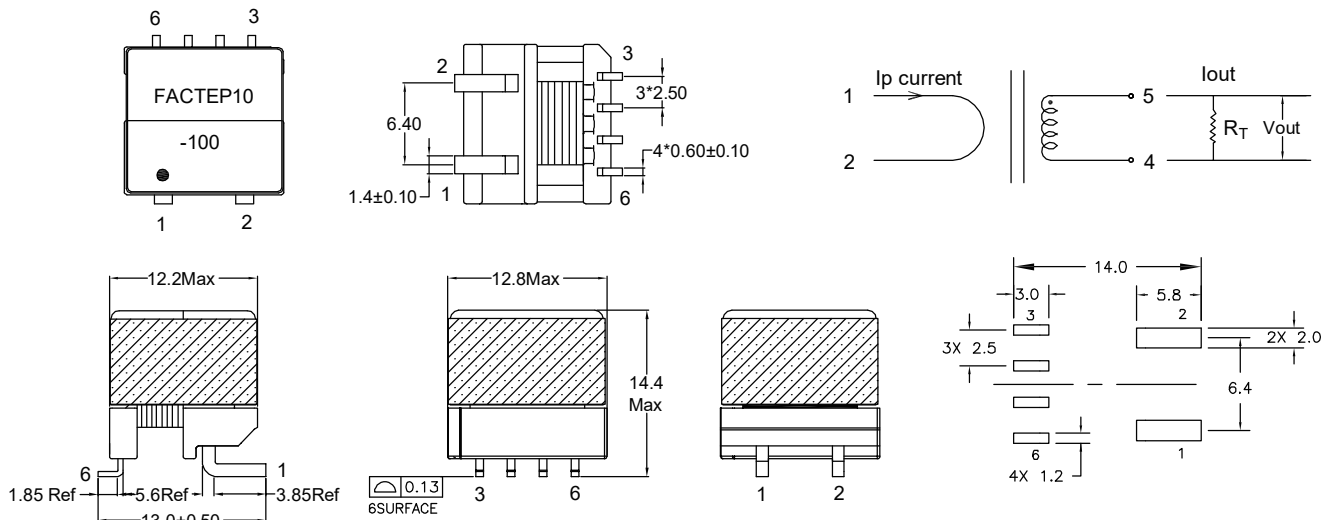

Customer to determine land layout